

# Omron TM Collaborative Robot: Software Manual TMFlow Version 2



This Manual contains information of the Techman Robot product series (hereinafter referred to as the TM Robot). The information contained herein is the property of Techman Robot Inc. (hereinafter referred to as the Corporation). No part of this publication may be reproduced or copied in any way, shape or form without prior authorization from the Corporation. No information contained herein shall be considered an offer or commitment. It may be subject to change without notice. This Manual will be reviewed periodically. The Corporation will not be liable for any error or omission.

**TM** logo is registered trademark of TECHMAN ROBOT INC. in Taiwan and other countries and the company reserves the ownership of this manual and its copy and its copyrights.

# Terms and Conditions Agreement

## Warranty Limitations of Liability

### Warranties

---

- Exclusive Warranty

Omron's exclusive warranty is that the Products will be free from defects in materials and workmanship for a period of twelve months from the date of sale by Omron (or such other period expressed in writing by Omron). Omron disclaims all other warranties, express or implied.

- Limitations

OMRON MAKES NO WARRANTY OR REPRESENTATION, EXPRESS OR IMPLIED, ABOUT NON-INFRINGEMENT, MERCHANTABILITY OR FITNESS FOR A PARTICULAR PURPOSE OF THE PRODUCTS. BUYER ACKNOWLEDGES THAT IT ALONE HAS DETERMINED THAT THE PRODUCTS WILL SUITABLY MEET THE REQUIREMENTS OF THEIR INTENDED USE.

Omron further disclaims all warranties and responsibility of any type for claims or expenses based on infringement by the Products or otherwise of any intellectual property right.

- Buyer Remedy

Omron's sole obligation hereunder shall be, at Omron's election, to (i) replace (in the form originally shipped with Buyer responsible for labor charges for removal or replacement thereof) the non-complying Product, (ii) repair the non-complying Product, or (iii) repay or credit Buyer an amount equal to the purchase price of the non-complying Product; provided that in no event shall Omron be responsible for warranty, repair, indemnity or any other claims or expenses regarding the Products unless Omron's analysis confirms that the Products were properly handled, stored, installed and maintained and not subject to contamination, abuse, misuse or inappropriate modification. Return of any Products by Buyer must be approved in writing by Omron before shipment. Omron Companies shall not be liable for the suitability or unsuitability or the results from the use of Products in combination with any electrical or electronic components, circuits, system assemblies or any other materials or substances or environments. Any advice, recommendations or information given orally or in writing, are not to be construed as an amendment or addition to the above warranty.

See <http://www.omron.com/global/> or contact your Omron representative for published information.

### Limitation of Liability; Etc.

---

OMRON COMPANIES SHALL NOT BE LIABLE FOR SPECIAL, INDIRECT, INCIDENTAL, OR CONSEQUENTIAL DAMAGES, LOSS OF PROFITS OR PRODUCTION OR COMMERCIAL LOSS IN ANY WAY CONNECTED WITH THE PRODUCTS, WHETHER SUCH CLAIM IS BASED IN CONTRACT, WARRANTY, NEGLIGENCE OR STRICT LIABILITY.

Further, in no event shall liability of Omron Companies exceed the individual price of the Product on which liability is asserted.

### Application Considerations

---

#### Suitability of Use

---

Omron Companies shall not be responsible for conformity with any standards, codes or regulations which apply to the combination of the Product in the Buyer's application or use of the Product. At Buyer's request, Omron will provide applicable third party certification documents identifying ratings and limitations of use which apply to the Product. This information by itself is not sufficient for a complete determination of the suitability of the Product in combination with the end product, machine, system, or other application or use. Buyer shall be solely responsible for determining appropriateness of the particular Product with respect to Buyer's application, product or system. Buyer shall take application responsibility in all cases.

NEVER USE THE PRODUCT FOR AN APPLICATION INVOLVING SERIOUS RISK TO LIFE OR PROPERTY WITHOUT ENSURING THAT THE SYSTEM AS A WHOLE HAS BEEN DESIGNED TO ADDRESS THE RISKS, AND THAT THE OMRON PRODUCT(S) IS PROPERLY RATED AND INSTALLED FOR THE INTENDED USE WITHIN THE OVERALL EQUIPMENT OR SYSTEM.

#### Programmable Products

---

Omron Companies shall not be responsible for the user's programming of a programmable Product, or any consequence thereof.



## Disclaimers

### Performance Data

---

Data presented in Omron Company websites, catalogs and other materials is provided as a guide for the user in determining suitability and does not constitute a warranty. It may represent the result of Omron's test conditions and the user must correlate it to actual application requirements. Actual performance is subject to the Omron's Warranty and Limitations of Liability.

- Change in Specifications

Product specifications and accessories may be changed at any time based on improvements and other reasons. It is our practice to change part numbers when published ratings or features are changed, or when significant construction changes are made. However, some specifications of the Product may be changed without any notice. When in doubt, special part numbers may be assigned to fix or establish key specifications for your application. Please consult with your Omron representative at any time to confirm actual specifications of purchased Product.

### Errors and Omissions

---

Information presented by Omron Companies has been checked and is believed to be accurate; however, no responsibility is assumed for clerical, typographical or proofreading errors or omissions.

## Table of Content

Revision History Table .....	20
General .....	21
1.1 Overview .....	21
1.2 Warning and Caution Symbols.....	21
1.3 Safety Precautions .....	22
1.4 Validation and Responsibility .....	23
1.5 Limitation of Liability .....	23
1.6 Statement of Responsibilities for Cyersecurity Threats .....	23
1.7 Functional Note Symbol.....	24
Start up and Activation.....	26
1.8 Overview .....	26
1.9 Start Up .....	26
1.9.1 Plug in the Power .....	26
1.9.2 Standard Start up.....	27
1.9.3 TM Robot Operations with TMflow .....	27
1.9.3.1 Local Operation Method .....	28
1.9.3.2 Wireless Access Point Connection Method .....	28
1.9.3.3 Wired Network Connection Method .....	30
1.10 MODE Switch .....	31
1.11 Start from Packing Pose .....	32
Safety Settings .....	34
1.12 Overview .....	34
1.13 Safety Permission Settings .....	34
1.14 Safety Settings .....	34
1.14.1 Function Buttons .....	35
1.14.1.1 Edit.....	35
1.14.1.2 New .....	36
1.14.1.3 Open.....	36
1.14.1.4 Default .....	36
1.14.1.5 Save .....	36
1.14.1.6 Apply.....	36
1.14.2 MODE .....	37
1.14.3 Speed & Force .....	37

1.14.3.1 General.....	37
1.14.3.2 Performance Safety .....	38
1.14.3.3 Human-Machine Safety .....	38
1.14.4 Soft Axis .....	40
1.14.4.1 Default & Additional .....	40
1.14.4.2 Joint Position Limit.....	40
1.14.4.3 Cartesian Limit A & Cartesian Limit B.....	40
1.14.5 Safety IO .....	41
1.14.5.1 Input Functions .....	41
1.14.5.2 Output Functions .....	42
1.14.5.3 Input Ports & Output Ports .....	42
1.14.6 Safety Tool .....	42
1.14.7 Mounting Direction .....	43
Start Your First Project.....	44
1.15 Overview .....	44
1.16 Initial Setting.....	44
1.17 M/A Mode and FreeBot.....	45
1.18 Build and Run the First Project .....	46
1.19 Project Override Speed .....	51
1.20 Shutdown .....	51
Operation Interface.....	53
1.21 Overview .....	53
1.22 Login/Logout.....	53
1.23 Connection .....	54
1.23.1 Local Connection .....	54
1.23.2 Remote Connection .....	54
1.24 View.....	55
1.24.1 Display Board.....	55
1.24.2 Flow .....	57
1.24.3 IO.....	58
1.24.4 Simulator.....	58
1.24.5 Status.....	59
1.24.6 Actioner.....	60
1.24.7 Force Sensor .....	60
1.25 Run Setting.....	60

1.26 Project .....	61
1.26.1 Project Editing Toolbar .....	61
1.26.1.1 File .....	62
1.26.2 Flow Project .....	64
1.26.2.1 Manager .....	65
1.26.2.2 Project Function.....	70
1.26.2.3 Others.....	75
1.26.3 Script Project.....	89
1.26.3.1 Manager .....	91
1.26.3.2 Project Function.....	91
1.26.3.3 Others.....	91
1.27 Configuration .....	92
1.27.1 Wizard.....	93
1.27.2 Vision Settings .....	93
1.27.3 Tool Settings .....	93
1.27.4 IO Setup.....	93
1.27.5 Safety.....	94
1.27.6 Controller .....	94
1.27.7 Speech.....	95
1.27.8 End Button .....	95
1.27.9 Component .....	96
1.27.10 Connection.....	96
1.27.11 Posture Settings .....	97
1.27.12 Service Engine Settings .....	98
1.27.13 Text File Manager.....	98
1.27.14 Motion Settings .....	99
1.28 System Setting .....	101
1.28.1 Language.....	101
1.28.2 System Update.....	102
1.28.3 User & Permission .....	103
1.28.4 Network.....	104
1.28.5 Import/Export .....	105
1.28.6 Date and Time.....	106
1.28.7 Network Service .....	107
1.28.8 Backup and Restore.....	108

1.28.9 Remote Control Settings .....	109
1.28.10 Hard Disk Space Analysis .....	109
1.28.11 Data Transfer.....	109
Point and Base .....	111
1.29 Overview .....	111
1.30 Base and Right-hand Rule.....	112
1.30.1 Right-hand Rule .....	112
1.30.2 Types of Base .....	112
1.30.2.1 Robot Base.....	112
1.30.2.2 Vision Base.....	113
1.30.2.3 Custom Base .....	113
1.30.2.4 Tool Coordinate.....	114
1.31 Point Parameter.....	114
1.31.1 Base Shift.....	115
1.31.2 Tool Shift .....	117
Create Base .....	119
1.32 Create Vision Base .....	119
1.33 Create a Custom Base .....	119
1.34 Create New Base Node .....	120
1.34.1 Create a New Base by Multiple Bases .....	121
1.34.1.1 Create a New Base with Two Vision Bases.....	121
1.34.1.2 Create a New Base with Three Vision Bases.....	121
1.34.2 Create a New Base with Three Points.....	122
1.34.2.1 Create a New Base with Three Points on the Vision Base .....	123
1.34.2.2 Create a New Base with Three Dynamic Points.....	123
Create the TCP.....	125
1.35 Overview .....	125
1.36 Tool Settings.....	125
1.36.1 Create Parameters of TCP with Hand Guidance Teaching .....	126
1.36.2 Create Tool Center Point by Input Parameters .....	129
Motion Programming .....	131
1.37 Overview .....	131
1.38 Point to Point (PTP).....	132
1.38.1 PTP is the Fastest Way to Move .....	132
1.38.2 Speed of PTP Motion .....	133

1.38.3 Plan for PTP Movement .....	133
1.38.4 PTP Smart Pose Choosing.....	134
1.39 Line .....	134
1.39.1 Line Moves the Shortest Distance.....	134
1.39.2 Speed of Line Motion .....	135
1.39.3 Plan for Line Movement .....	136
1.40 Two-Steps Motion (WayPoint).....	136
1.40.1 WayPoint.....	136
1.40.2 Plan for WayPoint Movement .....	138
1.41 Blending .....	138
1.41.1 Blending in Movement.....	138
1.41.2 Blending Speed Change Chart.....	139
1.41.3 Set the Blending Percentage.....	139
1.41.4 Set the Blending by Radius .....	140
1.42 Motion Nodes .....	140
1.42.1 Point Node .....	142
1.42.1.1 Generation Method of Point node .....	142
1.42.1.2 Point Node Setting.....	142
1.42.2 F-Point Node .....	143
1.42.3 Move Node.....	145
1.42.3.1 Plan for the Move Node .....	146
1.42.4 Circle Node .....	146
1.42.4.1 Circle Node Setting.....	146
1.42.4.2 Reach End Point.....	147
1.42.4.3 Target Central Angle .....	147
1.42.5 Path Node .....	148
1.42.5.1 Path and PLine .....	148
1.42.5.2 Path Node Setting.....	148
1.42.5.3 Path File Import and Export .....	150
1.42.6 Pallet Node .....	150
1.42.7 Listen Node.....	152
Logic Programming .....	155
1.43 Overview .....	155
1.44 Variable System.....	155
1.44.1 Local Variables.....	155

1.44.2 Global Variables .....	157
1.45 Logic Nodes .....	158
1.45.1 Start Node .....	158
1.45.2 SET Node .....	158
1.45.3 IF Node .....	162
1.45.4 WaitFor Node .....	163
1.45.5 Gateway Node .....	163
1.45.6 M-Decision Node.....	164
1.45.7 Script Node .....	165
1.46 Process .....	165
1.46.1 Process Nodes.....	165
1.46.2 Subflow Node.....	168
1.46.3 Thread.....	170
1.46.4 Add Pages From Other Projects.....	171
1.47 Modbus.....	175
1.47.1 Modbus System Hardware Structure.....	175
1.47.2 Modbus System Software Structure .....	175
1.47.2.1 Set Modbus TCP .....	175
1.47.2.2 Set Modbus RTU .....	176
1.47.3 Application of Modbus in Project .....	176
1.48 Network .....	179
1.48.1 Network Node .....	180
1.49 IO .....	180
1.49.1 User Defined IO .....	181
1.49.2 External IO .....	181
1.49.3 Status IO.....	181
1.50 Log Node.....	182
1.51 Display Node .....	184
1.52 Voice Node .....	184
Component.....	186
Force Related.....	189
1.53 Compliance node.....	189
1.54 F/T Sensor.....	194
1.54.1 Communication Setting .....	194
1.54.2 Position Setting .....	195

1.54.3 Import/Export Settings of F/T Sensor .....	197
1.54.4 Force Value and Charts.....	197
1.55 Touch Stop Node .....	198
1.55.1 Function Type: Compliance .....	199
1.55.2 Function Type: Line .....	200
1.55.3 Touch Stop Function Type: Force Sensor .....	202
1.56 Smart Insert Node .....	205
1.56.1 Approaching .....	205
1.56.1.1 Approaching principle description .....	205
1.56.1.2 Approaching parameters setting .....	206
1.56.2 Searching.....	206
1.56.2.1 Method for searching: Spiral .....	208
1.56.3 Pushing.....	210
1.56.3.1 Parameter Setting.....	210
1.57 Force Control Node .....	211
Operation Scene.....	219
1.58 Overview .....	219
1.59 Operation Scene Setting Page .....	219
1.60 Export/Import Operation Scene.....	219
1.60.1 Export Operation Scene .....	219
1.60.2 Import Operation Scene .....	219
TM Component Editor .....	222
1.61 Starting to create your first component .....	222
1.61.1 TM Component Editor settings .....	222
1.61.1.1 Start node.....	222
1.61.1.2 Node settings.....	225
1.61.2 TM Component Editor Naming Rule.....	227
1.61.2.1 Component Naming.....	228
1.61.2.2 Global Variables Naming .....	229
1.62 Devices.....	229
1.62.1 Modbus Devices.....	230
1.62.2 Network Devices .....	230
1.62.3 Force Sensing Devices .....	230
1.63 Features & Applicable Examples .....	230
1.63.1 Global Variables .....	230



1.63.2 Use component in TM Component Editor .....	231
1.63.3 Component Inheritance .....	232
1.63.4 The example of point parameterization application .....	232
1.63.5 The example of making parameterized devices .....	234
1.63.6 Use thread in TM Component Editor .....	235
1.63.7 Use subflow in TM Component Editor .....	236
1.63.8 Hide parameters .....	236
1.64 Use the component .....	237
1.64.1 Activate the component .....	237
1.64.2 Import/Export Components .....	238
1.66 Collision Check Node .....	239
Appendix A: Display of Indication Light Ring .....	241
Appendix B: Tables of Safety Parameter Upper and Lower Bounds .....	245
Appendix C: Modbus List .....	249
Appendix D: Ethernet Slave Data Table .....	265
Appendix E: Ethernet/IP Table .....	271
Appendix F: PROFINET Data Table .....	277
Appendix G: Error Descriptions and Suggestions .....	283

## Figures

Figure 2 - 1: The Indication Light Ring of The End Module with White Light .....	27
Figure 2 - 2: Wireless Access Point Connection Method (1/2) .....	29
Figure 2 - 3: Wireless Access Point Connection Method (2/2) .....	29
Figure 2 - 4: Wired Network Connection Method (1/2) .....	30
Figure 2 - 5: Wired Network Connection Method (2/2) .....	31
Figure 2 - 6: The Indication Light Ring of The End Module in Green .....	32
Figure 2 - 7: The Normal Poses .....	33
Figure 3 - 1: Safety Setting .....	35
Figure 4 - 1: AUTO MODE / MANUAL MODE .....	45
Figure 4 - 2: FREE Button .....	46
Figure 4 - 3: Build and Run the First Project (1/6) .....	47
Figure 4 - 4: Build and Run the First Project (2/6) .....	48
Figure 4 - 5: Build and Run the First Project (3/6) .....	48
Figure 4 - 6: Build and Run the First Project (4/6) .....	49
Figure 4 - 7: Build and Run the First Project (5/6) .....	50

Figure 4 - 8: Build and Run the First Project (6/6).....	50
Figure 4 - 9: Shutdown .....	52
Figure 5 - 1: Function Menu.....	53
Figure 5 - 2: Get/Release Control (Local) .....	54
Figure 5 - 3: View .....	55
Figure 5 - 4: Display (1/3) .....	56
Figure 5 - 5: Display (2/3) .....	56
Figure 5 - 6: Display (3/3) .....	57
Figure 5 - 7: IO .....	58
Figure 5 - 8: Simulator .....	59
Figure 5 - 9: Status .....	59
Figure 5 - 10: Project Editing Page .....	61
Figure 5 - 11: Open and Delete Project View .....	63
Figure 5 - 12: Project Edit.....	64
Figure 5 - 13: Point Manager (1/2).....	66
Figure 5 - 14: Point Manager (2/2).....	67
Figure 5 - 15: Base Manager .....	68
Figure 5 - 16: Display Manager .....	69
Figure 5 - 17: Stop Watch Setting Page.....	71
Figure 5 - 18: View Tool Floating Window .....	71
Figure 5 - 19: Serial Port .....	72
Figure 5 - 20: EditBlock (1/2).....	76
Figure 5 - 21: EditBlock (2/2).....	77
Figure 5 - 22: Searching Pane .....	78
Figure 5 - 23: Step Run .....	79
Figure 5 - 24: Comment.....	80
Figure 5 - 25: The Comment Note Editing Mode.....	80
Figure 5 - 26: Controller.....	81
Figure 5 - 27: Controller (FreeBot Control) .....	83
Figure 5 - 28: Joystick Control .....	86
Figure 5 - 29: Base List .....	89
Figure 5 - 30: Tool List.....	89
Figure 5 - 31: Script Editing Area.....	90
Figure 5 - 32: Configuration .....	93
Figure 5 - 33: Output Default Value Setting .....	94

Figure 5 - 34: Speech Setting .....	95
Figure 5 - 35: Gripper Button .....	96
Figure 5 - 36: Posture Settings .....	98
Figure 5 - 37: Text File Preview .....	99
Figure 5 - 38: System Settings .....	101
Figure 5 - 39: Language Setting .....	102
Figure 5 - 40: System Update (1/2).....	102
Figure 5 - 41: System Update (2/2).....	103
Figure 5 - 42: User Account.....	104
Figure 5 - 43: Network Setting .....	105
Figure 5 - 44: Date Time.....	107
Figure 5 - 45: Network Services .....	107
Figure 5 - 46: Backup\Restore.....	109
Figure 6 - 1: Base Value of the Point .....	111
Figure 6 - 2: Coordinate Axis Rotation .....	111
Figure 6 - 3: Right-Hand Base .....	112
Figure 6 - 4: Robot Base .....	113
Figure 6 - 5: Servoing Vision Base is on the Camera.....	113
Figure 6 - 6: Fix-point Vision Base is on the Object .....	113
Figure 6 - 7: Tool Coordinates .....	114
Figure 6 - 8: Point Parameter Information.....	115
Figure 6 - 9: Shift Function of Point Node .....	115
Figure 6 - 10: Base Shift Schematic Diagram .....	116
Figure 6 - 11: Node with Base Shift .....	116
Figure 6 - 12: Node with Tool Shift .....	117
Figure 6 - 13: Tool Shift Using Keep Pose.....	118
Figure 6 - 14: Tool Shift Using Keep Path.....	118
Figure 7 - 1: Base Manager .....	119
Figure 7 - 2: Build a Base by 3 Points.....	120
Figure 7 - 3: New Base Node .....	121
Figure 7 - 4: Create a New Base with Two Vision Bases .....	121
Figure 7 - 5: Create a New Base with Three Vision Bases.....	122
Figure 7 - 6: Create a New Base with Three Points .....	123
Figure 7 - 7: Create a New Base with Three Points on the Vision Base.....	123
Figure 7 - 8: Create a New Base with Three Dynamic Points .....	124

Figure 8 - 1: TCP Definition .....	125
Figure 8 - 2: Tool Settings .....	126
Figure 8 - 3: Set the Times of Calibration .....	127
Figure 8 - 4: Teaching Screen .....	127
Figure 8 - 5: The Robot Posture Needs to Change during Teaching (1/2) .....	127
Figure 8 - 6: The Robot Posture Needs to Change during Teaching (2/2) .....	128
Figure 8 - 7: Save Teaching Result .....	129
Figure 8 - 8: Set Tool Parameters.....	129
Figure 9 - 1: TM Robot Motion Modes .....	131
Figure 9 - 2: PTP Motion .....	133
Figure 9 - 3: Speed of PTP Motion .....	133
Figure 9 - 4: PTP Application Examples .....	134
Figure 9 - 5: PTP Smart Pose Choosing.....	134
Figure 9 - 6: Line Motion.....	135
Figure 9 - 7: Speed of Line .....	135
Figure 9 - 8: Link to Project Speed .....	135
Figure 9 - 9: Line Application Example .....	136
Figure 9 - 10: WayPoint Motion Status .....	137
Figure 9 - 11: WayPoint Setting .....	138
Figure 9 - 12: WayPoint Application Examples .....	138
Figure 9 - 13: Blending in Space.....	138
Figure 9 - 14: Blending Speed Change Chart.....	139
Figure 9 - 15: Set the Blending Percentage or Set the Blending by Radius .....	139
Figure 9 - 16: Motion Nodes Support Variable as the Inputs.....	141
Figure 9 - 17: Speed Adjust and Speed Indication on the Node.....	141
Figure 9 - 18: Point Node .....	142
Figure 9 - 19: Point Node Setting.....	143
Figure 9 - 20: F-Point Node .....	144
Figure 9 - 21: F-Point Node Setting .....	144
Figure 9 - 22: Adjust F-Point Parameter during Project Running .....	145
Figure 9 - 23: Move Node Setting .....	145
Figure 9 - 24: Plan for the Move Node.....	146
Figure 9 - 25: The Circle Node Plans Arc Path with 3-Point Setting Circle.....	146
Figure 9 - 26: Circle Node Setting.....	147
Figure 9 - 27: The Circle Motion Status of Reach End Point Setting .....	147

Figure 9 - 28: The Circle Motion Status of Set Angle =270° .....	148
Figure 9 - 29: PLine Blending Relationship Chart .....	148
Figure 9 - 30: Path Node Setting .....	149
Figure 9 - 31: Pallet Node.....	151
Figure 9 - 32: Pallet Patterns .....	152
Figure 9 - 33: Listen Node .....	153
Figure 10 - 1: Variable System .....	156
Figure 10 - 2: Global Variable Setting.....	157
Figure 10 - 3: SET Node.....	159
Figure 10 - 4: Variable Count.....	159
Figure 10 - 5: Expression Editor Parameters (1/2).....	160
Figure 10 - 6: Expression Editor Parameters (2/2).....	161
Figure 10 - 7: Add Expression .....	161
Figure 10 - 8: Analog I/O Setting .....	162
Figure 10 - 9: IF Node .....	162
Figure 10 - 10: IF Node Stop Criteria Setting .....	163
Figure 10 - 11: Gateway Node Judges Five Conditions .....	164
Figure 10 - 12: IF Node Judges Four Conditions .....	164
Figure 10 - 13: Stop Node Ends Project .....	166
Figure 10 - 14: Goto Node Flow Transfer .....	166
Figure 10 - 15: Goto Node Connection .....	166
Figure 10 - 16: Warp Node Transfers to another Project .....	167
Figure 10 - 17: Subflow Node Modularization Concept.....	168
Figure 10 - 18: Menu to Create Subpages.....	169
Figure 10 - 19: Select a subflow in the subflow node (1/2).....	169
Figure 10 - 20: Select a subflow in the subflow node (2/2).....	170
Figure 10 - 21: Thread.....	170
Figure 10 - 22: Add Pages from Other Projects .....	171
Figure 11 - 1: Vision Node.....	173
Figure 11 - 2: Vision Node Flow .....	173
Figure 11 - 3: Vision Node Setting .....	174
Figure 12 - 1: Robot Modbus Protocol .....	175
Figure 12 - 2: Modbus Device Access .....	176
Figure 12 - 3: Modbus TCP Local IP.....	177
Figure 12 - 4: Modbus Device Setting.....	178

Figure 12 - 5: Modbus X Axis Position Parameter Setting .....	179
Figure 12 - 6: Network Setting .....	180
Figure 12 - 7: Status IO Setting .....	182
Figure 12 - 8: Log Node Gets the Current Angle.....	183
Figure 12 - 9: Log Node Setting.....	184
Figure 12 - 10: Node Text Example .....	184
Figure 12 - 11: Display Node Setting .....	184
Figure 12 - 12: Voice Node in TMflow Application .....	185
Figure 13 - 1: Select Components .....	186
Figure 13 - 2: Component List .....	187
Figure 13 - 3: Gripper Button Setting Page.....	188
Figure 14 - 1: Compliance Node .....	189
Figure 14 - 2: Compliance Node Teach Setting .....	191
Figure 14 - 3: Line Direction .....	192
Figure 14 - 4: Rotation Direction .....	192
Figure 14 - 5: Compliance Variable Selection .....	193
Figure 14 - 6: F/T Sensor .....	194
Figure 14 - 7: Read Values after Setting F/T Sensor .....	195
Figure 14 - 8: Position Setting .....	196
Figure 14 - 9: Select Position Setting.....	196
Figure 14 - 10: Input Values .....	197
Figure 14 - 11: Charts.....	198
Figure 14 - 12: Touch Stop-Compliance Settings .....	199
Figure 14 - 13: Touch Stop-Line Settings .....	201
Figure 14 - 14: Touch Stop-Force Sensor.....	202
Figure 14 - 15: Force Sensor.....	203
Figure 14 - 16: Approaching Principle.....	205
Figure 14 - 17: Approaching Parameter Setting.....	206
Figure 14 - 18: Spiral Searching Method .....	207
Figure 14 - 19: Line Searching Method (1/2) .....	207
Figure 14 - 20: Line Searching Method (2/2) .....	207
Figure 14 - 21: Spiral Searching Parameter Setting Interface.....	209
Figure 14 - 22: Linear Searching Parameter Setting Interface .....	210
Figure 14 - 23: Pushing Parameter Interface .....	211
Figure 14 - 24: Force Control Node Settings .....	211

Figure 14 - 25: Tool Coordinate System .....	212
Figure 14 - 26: Base Coordinate System .....	212
Figure 14 - 27: Trajectory Coordinate System .....	213
Figure 14 - 28: Possible Conversion Error .....	213
Figure 14 - 29: F/T Operation Modes – Setpoint.....	214
Figure 14 - 30: F/T Operation Modes – Trajectory (1/3).....	215
Figure 14 - 31: F/T Operation Modes – Trajectory (2/3).....	215
Figure 14 - 32: F/T Operation Modes – Trajectory (3/3).....	216
Figure 14 - 33: Stop Criteria – F/T Reached .....	217
Figure 15 - 1: Import Operation Scene (1/3) .....	220
Figure 15 - 2: Import Operation Scene (2/3) .....	220
Figure 15 - 3: Import Operation Scene (3/3) .....	221
Figure 16 - 1: Start Node .....	223
Figure 16 - 2: Node Setting (1/2) .....	226
Figure 16 - 3: Node Setting (2/2) .....	227
Figure 16 - 4: Global Variables Naming .....	229
Figure 16 - 5: Global Variables .....	231
Figure 16 - 6: The Example of Point Parameterization Application (1/4) .....	232
Figure 16 - 7: The Example of Point Parameterization Application (2/4) .....	233
Figure 16 - 8: The Example of Point Parameterization Application (3/4) .....	234
Figure 16 - 9: The Example of Point Parameterization Application (4/4) .....	234
Figure 16 - 10: The Example of Making Parameterized Devices .....	235
Figure 16 - 11: Hide Parameters.....	237
Figure 16 - 12: Activate the Component .....	238
Figure 17 - 1: Collision Check Node .....	240

## Tables

Table 1: Hardware Versions and Applicability .....	21
Table 2: Warning and Caution Symbols.....	22
Table 3: Functional Note Symbols .....	25
Table 4: Project Override Speed Adjustment and Record Method .....	51
Table 5: FreeBot Degree of Freedom Limitation .....	83
Table 6: Joystick Icon Descriptions.....	85
Table 7: Joystick Button Definitions .....	87
Table 8: Quick Control.....	88

Table 9: Script Editing Items.....	90
Table 10: User Defined IO Setting Table .....	94
Table 11: Valid Blending Setting (Moving from P1 to P2) .....	140
Table 12: Variable Data Types .....	156
Table 13: SET Syntax List.....	160
Table 14: If Judgment Operators .....	163
Table 15: TM Robot Coordinates in the Modbus List .....	176
Table 16: User Defined IO Setting Table .....	181
Table 17: Spiral Searching Function Setting Parameters Definition .....	208
Table 18: Linear Searching Function Setting Parameter Definition.....	209
Table 19: Pushing Parameter Definitions.....	210
Table 20: Component Naming.....	228
Table 21: Naming Rule for Items after Components .....	229
Table 22: Blinking Ratio.....	242
Table 23: Light Indications.....	243
Table 24: Quick References of Color/Blinking .....	244



### Revision History Table

Revision Code	Date	Revised Content
A	June, 2023	Original release

## General

### 1.1 Overview

TMflow is a graphical human-machine interface (HMI). Its purpose is to provide users with a complete, convenient and simple interface for robot motion and logic programming environments. Through the graphical HMI, users can simply manage and set the parameters of the robot, and use the graphical flow chart to plan the robot movement and process logic. At the same time, the interface design of TMflow considers the use of touch screens, allowing you to manage multiple robots from a single Windows tablet.

Users and system integrators of TM Robot must read and fully understand this chapter before using this robot. In addition, before users perform any operation on the robot in accordance with this manual, it is necessary to read and comply with the Safety Manual for the corresponding product's hardware and software version, and the Hardware Installation Manual for the corresponding hardware version, before the operation can be performed.

This manual applies to TMflow Version 2.14 or above and adapts to HW5.0 mainly. Confirm your software version before using and reading this manual. To check the software version, click  at the top right of TMflow.

The table below describes the applicability of this software to the hardware versions of each TM Robot.

Hardware Version	Applicability
HW 5.0	Applicable

Table 1: Hardware Versions and Applicability



#### NOTE:

- In this software, the naming rules for custom names and paths are restricted to use: the Latin alphabet, numbers, and underscores. The naming must go with an underscore or an alphabet in upper or lower case and without a number as the first character due to taking specified names and paths as variables.

### 1.2 Warning and Caution Symbols

The Table below shows the definitions of the warning and caution levels used in this manual. Pay close attention to them when reading each paragraph, and observe them to avoid personal injuries or equipment damage.



**DANGER:**

Identifies an imminently hazardous situation which, if not avoided, is likely to result in serious injury, and might result in death or severe property damage.



**WARNING:**

Identifies a potentially hazardous situation which, if not avoided, will result in minor or moderate injury, and might result in serious injury, death, or significant property damage.



**CAUTION:**

Identifies a potentially hazardous situation which, if not avoided, might result in minor injury, moderate injury, or property damage.

Table 2: Warning and Caution Symbols

### 1.3 Safety Precautions



**DANGER:**

This product can cause serious injury or death, or damage to itself and other equipment, if the following safety precautions are not observed:

- All personnel who install, operate, teach, program, or maintain the system must read the *Hardware Installation Manual*, *Software Manual*, and *Safety Manual* for the software and hardware version of this product, and complete a training course for their responsibilities in regard to the robot.



Read Manual



Impact Warning

- All personnel who design the robot system must read the *Hardware Installation Manual*, *Software Manual*, and *Safety Manual* for the software and hardware version of this product, and must comply with all local and national safety regulations for the location in which the robot is installed.
- The TM Robot shall be used according to its intended use.
- Results of the risk assessment may require the use of additional risk reduction measures.
- Power to the robot and its power supply must be locked out and tagged out or have means to control hazardous energy or implement energy isolation before any maintenance is performed.
-  Dispose of the product in accordance with the relevant rules and regulations of the country or area where the product is use.

## 1.4 Validation and Responsibility

The information provided in this Manual does not include how to design, install and operate a complete arm application, nor does it involve the peripheral devices that will affect the overall system safety. The design and installation of the complete system must comply with the standards and regulations for safety requirements in the country located. Users or integrators should understand safety laws and safety regulations in the local country, and avoid major risks present in the entire system.

This includes but is not limited to:

- Risk assessment of the whole system
- Adding other machines and additional risk reduction measures based on the results of the risk assessment
- Using appropriate software safety features
- Ensuring the user will not modify any safety measures
- Ensuring all systems are correctly designed and installed
- Clearly labeling user instructions
- Clearly marked symbols for installation of the robot arm and the integrator contact details
- Making accessible relevant documents, including the risk assessment and this manual.

## 1.5 Limitation of Liability

No safety-related information shall be considered a guarantee by the Corporation that a TM Robot will not cause personnel injury or property damage.

## 1.6 Statement of Responsibilities for Cybersecurity Threats

To maintain the security and reliability of the system, a robust cybersecurity defense program should be implemented, which may include some or all of the following:

### **Anti-virus protection**

- Install the latest commercial-quality anti-virus software on the computer connected to the control system and keep the software and virus definitions up-to-date.
- Scan USB drives or other external storage devices before connecting them to control systems and equipment.

### **Security measures to prevent unauthorized network access**

- Install physical controls so that only authorized personnel can access control systems and equipment.
- Reduce connections to control systems and equipment via networks to prevent access from untrusted devices.

- Install firewalls to block unused communications ports and limit communication between systems. Limit access between control systems and systems from the IT network.
- Control remote access and adopt multifactor authentication to devices with remote access to control systems and equipment.
- Set strong password policies and monitor for compliance frequently.

#### **Data input and output protection**

- Backup data and keep the data up-to-date periodically to prepare for data loss.
- Validate backups and retention policies to cope with unintentional modification of input/output data to control systems and equipment.
- Validate the scope of data protection regularly to accommodate changes.
- Check validity of backups by scheduling test restores to ensure successful recovery from incidents.
- Safety design, such as emergency shutdown and fail-soft operations in case of data tampering and incidents.

#### **Additional recommendations**

- When using an external network environment to connect to an unauthorized terminal such as a SCADA, HMI or to an unauthorized server may result in network security issues such as spoofing and tampering.
- You must take sufficient measures such as restricting access to the terminal, using a terminal equipped with a secure function, and locking the installation area by yourself.
- When constructing network infrastructure, communication failure may occur due to cable disconnection or the influence of unauthorized network equipment.
- Take adequate measures, such as restricting physical access to network devices, by means such as locking the installation area.
- When using devices equipped with an SD Memory Card, there is a security risk that a third party may acquire, alter, or replace the files and data in the removable media by removing or unmounting the media.

### 1.7 Functional Note Symbol

The following table defines the functional note symbols used in this manual. Read the paragraphs carefully.



#### **IMPORTANT:**

This symbol represents the relevant functional details to assist the programming and use.

Note

**NOTE:**

This symbol represents the relevant functional use tips to assist programming efficiency

Table 3: Functional Note Symbols

## Start up and Activation

### 1.8 Overview

This manual instructs users of TM Robot to perform start up procedures for the first time. Users must first read and follow the *Safety Manual* for the corresponding product's software and hardware version, and the *Hardware Installation Manual* for the corresponding hardware version to install the TM Robot correctly and properly before executing the operation of this chapter; otherwise, it may result in serious risks.



#### **WARNING:**

The following chapters of this manual will describe how to install the TM Robot after unpacking the box. If it is your first time to install TM Robot without learning all the installation process starting from unpacking the new product, especially when the robot has been installed in a working environment, pay attention to the following items in order to perform first time installation and startup operation according to this manual:

1. In order to avoid the risks of resuming work caused by the changes of the original working environment and configuration, check with the responsible person for the working environment and keep all necessary configuration records, such as software settings and all hardware wirings.
2. Remove all IOs for the external connection of the **Control Box**, including analog IO, digital IO, EtherCAT connection port and network ports. Remove all air lines or external power lines connecting to the optional equipment before Commissioning.
3. Remove all **Control Box** external USB interface, serial port, and external connection / external storage device connections of the network interface.
4. Uninstall any added objects / end-effectors installed to the end flange and any electrical connections between the end effector and the **End Module / Control Box**.
5. Uninstall any hardware that is installed outside the robot body.

#### Note

#### **NOTE:**

For the need to connect external monitors, using the officially designated TM Plug&Play display module is recommended and adequate for the optimal display presentation.

### 1.9 Start Up

#### 1.9.1 Plug in the Power

Plug the **Power Cable of Control Box** into the **power socket**.

**WARNING:**

For the procedure from product unpacking to plugging the **Power Cable of the Control Box** into the **power socket**, read and follow the corresponding contents of the *Hardware Installation Manual*.

### 1.9.2 Standard Start up

- Step 1** Check that the environment clearance and robot's posture are safe.
- Step 2** Check that the **Emergency Switch of Robot Stick** is released.
- Step 3** Press the **Power button** on the **Robot Stick** to start the robot.
- Step 4** While starting up, the **Indication Light Ring** of the **End Module** flashes in yellow.
- Step 5** After starting up, the Indication Light Ring of the End Module will light in white constantly. Users can use the robot ordinarily at this time.

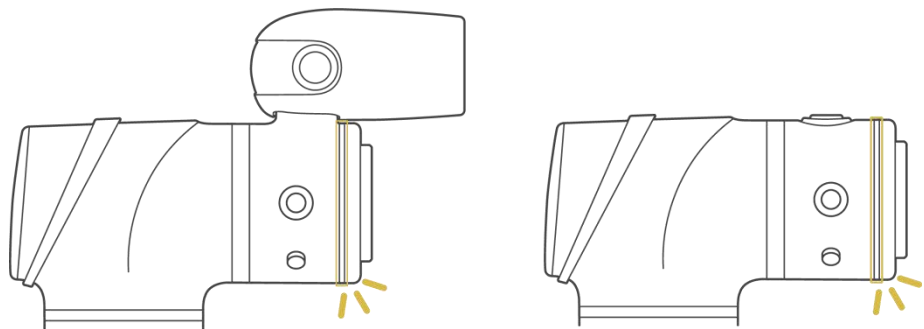

Figure 2 - 1: The Indication Light Ring of The End Module with White Light

### 1.9.3 TM Robot Operations with TMflow

Users can operate **TMflow** in following ways:

- Local operation:
  1. Connect a monitor\*, a keyboard, and a mouse to the **Control Box**.
  2. Start to operate **TMflow**. Refer to 1.9.3.1 for details.

**Note****NOTE:**

\*Please use a monitor with a resolution of 1280 x 800, 1366 x 768, or 1920 x 1080 to avoid screen distortion.

- Remote operation:
  1. Download the **TMflow Client** from the customer area of the official website, and install it on a Windows-based computer such as a Windows laptop or a Windows tablet.



2. Connect the computer to the robot in a wireless or a wired network. Refer to 1.9.3.2 or 1.9.3.3 for details.



**NOTE:**

Minimum requirements of the client device to install **TMflow Client** are as follows:

<b>Operating System:</b>	Windows 7, Windows 8/8.1, Windows 10
<b>CPU:</b>	Intel i5 series compatibles or above
<b>RAM:</b>	4 GB at least
<b>Hard Drive Space:</b>	2 GB of available space
<b>Display Resolution:</b>	Must be set to 1280 x 800, 1366 x 768, 1920 x 1080, or 2736 x 1824.
<b>Display Scale:</b>	100% or 125%
<b>Supported Languages:</b>	English, Traditional Chinese, Simplified Chinese, Japanese, German, Korean, Vietnamese, Spanish, French, Italian, Danish, Dutch, Czech, Hungarian, Romanian, Portuguese, Turkish, Polish, Thai
<b>Additional Requirements:</b>	<ol style="list-style-type: none"><li>1. 2010Redistributable_vcrist (x64) 10.0.30319 or above.</li><li>2. 2013Redistributable_vcrist (x64) 12.0.30501 or above.</li><li>3. 2015-2022Redistributable_vcrist (x64) or above.</li><li>4. 7-Zip 16.04 or above.</li><li>5. Working Internet connection</li></ol>

### 1.9.3.1 Local Operation Method

- Step 1** Connect a monitor, a mouse, and a keyboard, to the **Control Box**.
- Step 2** Navigate to  and click **Login**.  
**Administrator** by default is not set with password. Click **OK** to login directly.
- Step 3** Click **Get Control** to get control of the robot.

### 1.9.3.2 Wireless Access Point Connection Method

- Step 1** Install **TMflow Client** on a Windows-based computer as the client device.
- Step 2** Connect the robot to the same physical AP or entity AP of the same network segment.

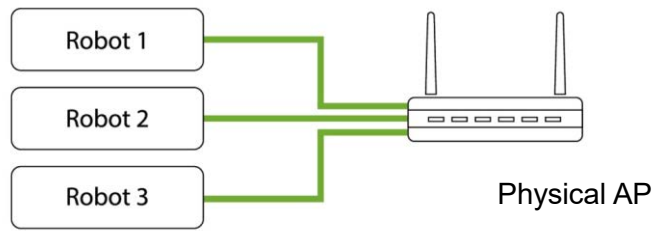

Figure 2 - 2: Wireless Access Point Connection Method (1/2)

**Step 3** Connect the client device network to the above local area network.

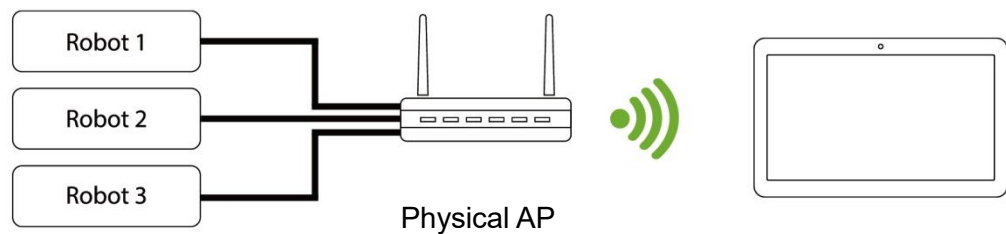



Figure 2 - 3: Wireless Access Point Connection Method (2/2)

**Step 4** Log on to the client device using a Windows account with the administrator's rights.



**NOTE:**  
Using a non-Admin Windows account will fail to launch TMflow even if right-clicking **Run as Administrator**.

**Step 5** Launch **TMflow** on the client device, click  to refresh the list, and wait for the corresponding Robot name to appear in the list.

**Step 6** Click the Robot IP address and click the Connect button to connect to the robot. Ensure that all the robots in this network segment appear on the screen. Users can distinguish the connecting robot by the robot's Robot ID (the number below the barcode on the control box). In addition, users also can directly enter the Robot IP address in the input box at the top left to connect the known robot.

**Step 7** Click **Get Control** to control the robot.



**CAUTION:**

Do not mistakenly insert the network cable into the dedicated **EtherCAT port** of the **Control Box**. This action will trigger a robot error.

### 1.9.3.3 Wired Network Connection Method

- Step 1** Install **TMflow Client** on a Windows-based computer as the client device.
- Step 2** Connect the robot and the client device to the same physical AP or the physical AP on the same network segment, or connect the two ends of the network wires to the robot **Control Box** and the client device.
- Step 3** Log on to the client device using a Windows account with the administrator's rights.



**NOTE:**

Using a non-Admin Windows account will fail to launch TMflow even if right-clicking **Run as Administrator**.

- Step 4** Launch **TMflow** on the client device, click  to refresh the list, and wait for the respective Robot ID to appear on the list.
- Step 5** Click the Robot IP address and click the Connect button to connect to the robot. Ensure that all the robots in this network segment appear on the screen. Users can distinguish the connecting robot by the robot's Robot ID. In addition, users also can directly enter the Robot IP address in the input box at the top left to connect the known robot.
- Step 6** Click **Get Control** to control the robot.

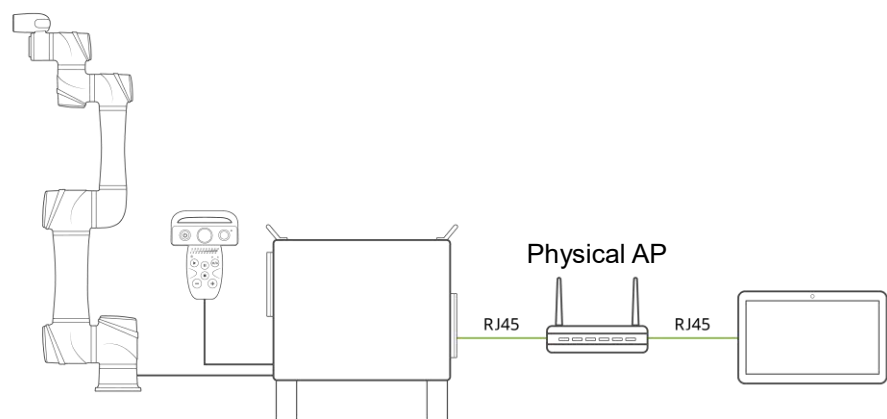

Figure 2 - 4: Wired Network Connection Method (1/2)

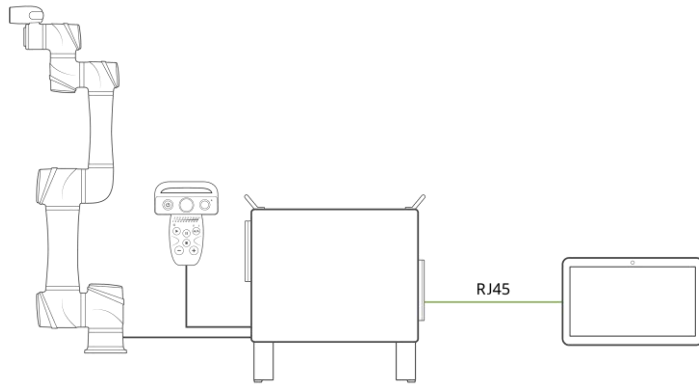

Figure 2 - 5: Wired Network Connection Method (2/2)

### 1.10 MODE Switch

While under Local Control (Robot Stick is at ON Status), the robot is in AUTO MODE by default after booting up. The MODE switch functions follow the Robot Stick MODE switch function result. For details of the Operation Mode, please refer to *Safety Manual*.

The method to switch MODE is as follows:

- Step 1** Press and hold the **M/A** button on Robot Stick.
- Step 2** Type in a valid password.
- Step 3** Press the **M/A** button to send out the password, and the system will wait 30 seconds for the confirmation.
- Step 4** Press the **M/A** button to confirm or the STOP button to cancel.

After finishing the steps above, the robot will be in MANUAL MODE directly, and the Indication Light Ring of the End Module will constantly display in green. It is okay to use the robot at this time.

Users can use the MODE switch function in any situation, and the methods to switch between MANUAL MODE and AUTO MODE are the same.

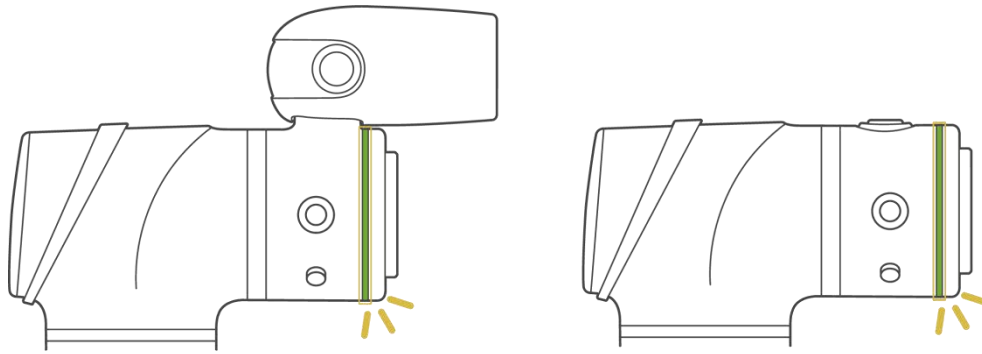

Figure 2 - 6: The Indication Light Ring of The End Module in Green

The default password of the Robot Stick is + - + + - . Users can change the password by authorization. To change the password, refer to the respective chapter of Safety Settings.



**WARNING:**

Users should consider the strength and the complexity of passwords to prevent unauthorized decryption. Users are responsible for ensuring the password security and the correctness of the safety configuration in advance.



**DANGER:**

Any suspended safeguards shall be set back to full functionality before selecting automatic operation.



**NOTE:**

- To lock the Robot Stick in either AUTO MODE or MANUAL MODE, press and hold the - button until Robot Stick Enable Indicator starts blinking, and then press the +/- button in the sequence of -+ -+. The Robot Stick is now locked in the respective MODE, and the system beeps when pressing any button on the Robot Stick.
- To unlock the Robot Stick in either AUTO MODE or MANUAL MODE, press and hold the - button until Robot Stick Enable Indicator starts blinking, and then press the +/- button in the sequence of -+ -+. It unlocks the Robot Stick now in the respective MODE.
- Users can press and hold the power button on the Robot Stick to shut down the system.

### 1.11 Start from Packing Pose

This section describes how to start from Packing Pose. Only by having read all instructions, having understood the content of this manual, and having set the TM Robot correctly by the contents of Chapter 3 can users perform procedures in this section.

**Step 1** Connect a monitor, a mouse, and a keyboard, to the **Control Box**.

**Step 2** Navigate to ≡ and click **Login. Administrator** by default is not set with password. Click

**OK** to login directly.

**Step 3** Click **Get Control** to get control of the robot.

**Step 4** Change Operation Mode to MANUAL MODE.

**Step 5** Navigate to  $\equiv$  and click **Configuration > Posture Settings**. Choose **Normal Pose**.

**Step 6** Press and hold the Enabling Switch slightly and continuously press the (▶) button on the Robot Stick to set the robot to **Normal Pose**.



**CAUTION:**

When finishing starting from the Packing Pose, use the **TMflow Posture Settings or Controller** to move the robot posture to the **Home Pose** (each joint angle: 0, 0, 0, 0, 0, 0), or **Normal Pose** (each joint angle: 0, 0, 90, 0, 90, 0) as shown below. Note that the Joint 2 pointing directions of the **Normal Pose** and the safe posture are opposite after unpacking.

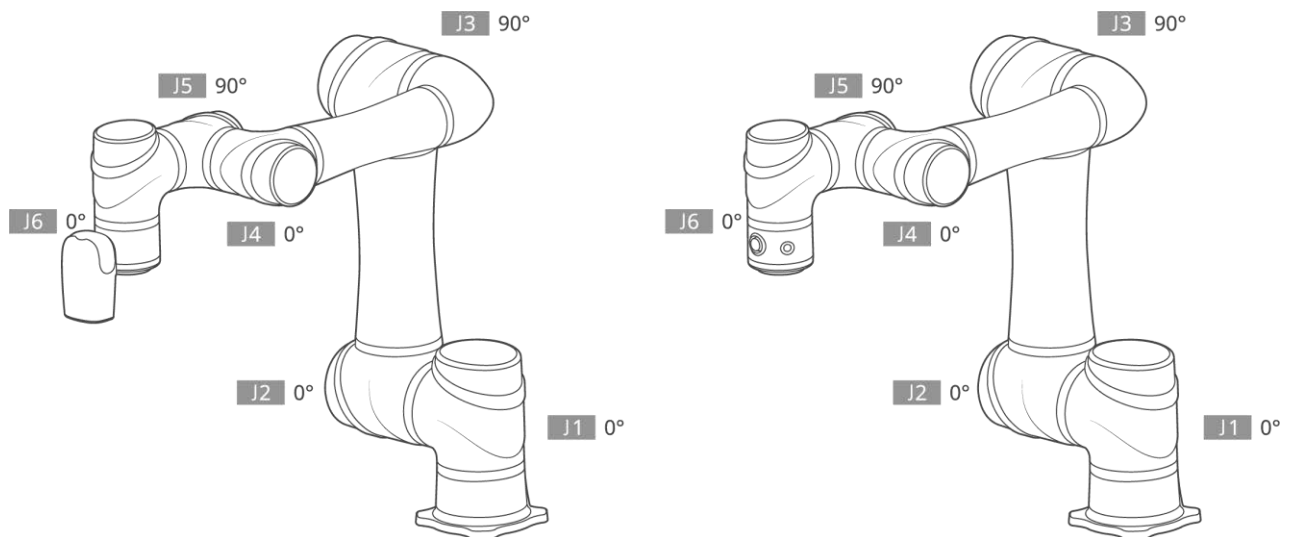

Figure 2 - 7: The Normal Poses

## Safety Settings

### 1.12 Overview

The following sections will introduce the safety settings interface of the TM Robot, including the Safety Permission Settings and Safety Setting.



Note

**NOTE:**

Upgrading the software with previous versions of hardware will not upgrade the version of the safety system.

### 1.13 Safety Permission Settings

Users and administrators of TM Robot must set appropriate account password permissions before starting to use the TM Robot, with proper arrangements for access to operator permission for safety configuration.

When users have completed the startup and activation according to the previous chapter and entered the **TMflow** interface with the default account password to get the control of the robot, navigated to ≡ and clicked **Configuration** to enter the setting page, an option labeled **Safety** will appear on this page. It is the safety settings operation area of the product with all the critical settings for the robot. If settings are changed arbitrarily, it will cause danger during operation. For proper permission settings, refer to 1.28.3 User & Permissions to create accounts for authorization to access the safety- related setting permissions and grant permission to access **Configuration** to set other accounts and group privileges to access **Configuration** to change the safety permission settings.

### 1.14 Safety Settings

The **Safety Settings** page comes with function buttons including **Edit, New, Open, Default, Save, and Apply**, and settings of **MODE, Speed & Force, Soft Axis, Safety IO, Safety Tool, and Mounting Direction** in the Configuration Tool. These functions deliver a Safety Checksum at the top right to verify the system integrity. Changes in these functions renew the Safety Checksum if applied. The version of the Safety System is at the bottom left of the screen. There is also a timestamp of the last modified date and time at the bottom left of the screen. The timestamp is updated and expressed according to ISO 8601 every time users click the **Apply** button and confirm the new parameters.

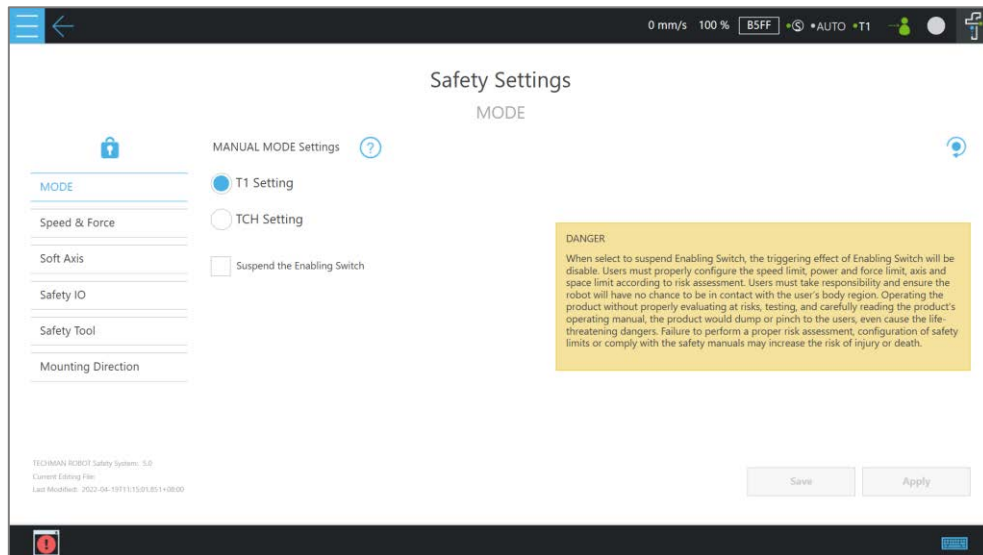

Figure 3 - 1: Safety Setting

**Note**

**NOTE:**

The Safety Settings of Safety System 3.3 varies from that of Safety System 5.1. Please refer to the Safety Manual of the respective Safety System for details.

### 1.14.1 Function Buttons

This section will disclose the function buttons for the configuration of safety parameters.

#### 1.14.1.1 Edit

Click  to start to configure the safety parameters and the safety passwords. After logging in to the Configuration Tool with a valid password, users can configure the safety parameters to apply to the safety module and change the passwords of the Configuration Tool and the Robot Stick. To change either of the passwords, click the respective item to input the current password, the new password, the new password again for confirmation, and make the change.

**Note**

**NOTE:**

Certain robot operations will not work, such as Recovering from ESTOP, until users stop editing safety settings by either Saving or Canceling.

The default password of the Configuration Tool is 00000000, and users can change the password with 4 to 8 alphanumeric characters.

The default password of the Robot Stick is + - + + - , and users can replace the password with



the combination of 4~8 keystrokes of + and -.





**WARNING:**

Users should consider the strength and the complexity of the password to prevent unauthorized decryption. It is the users' responsibility to ensure the password security and the correctness of safety configuration in advance.

#### 1.14.1.2 New

Click  to create a new configuration file with all the safety parameters set to the defaults by different robot model types. Users can apply these settings directly or change any safety parameter according to the risk assessment. Immediately using the default turns all safety settings back to the default.

#### 1.14.1.3 Open

Click  to open the existing configuration file. All the existing configuration files are present with their Safety Checksums. Users can delete the existing configuration files by clicking . The name of currently opened configuration file shows at the bottom left of the screen.

#### 1.14.1.4 Default

Click  to set values for the safety parameters in current settings page to default values by different robot model types.

#### 1.14.1.5 Save

Click the save icon to save the safety parameter values in the setting page into a configuration file. The configuration file naming supports Latin alphabet letters in upper case and lower case (A-Z, a-z), Arabic digits (0-9), and the character `_`. The configuration file saves with its Safety Checksum.

#### 1.14.1.6 Apply

Click the apply icon to apply the safety parameter values in the setting page to the safety module. After clicking, all the safety parameter information will present in a sheet for users to confirm whether to apply these values. If confirming YES by checking the checkbox at the bottom of the sheet, click **Apply** to apply these values to the safety module. After applying, a pop-out window will be displayed for users to save the sheet to an external flash drive. Note that the flash drive must be labeled **TMROBOT**.

## 1.14.2 MODE

On this page, users can configure either the T1 Setting or the TCH Setting to have the MANUAL MODE map to either T1 MODE or TCH MODE (Teaching MODE). Users can also configure the Enabling Switch Functions by the risk assessment and the integration. For details of these MODEs, refer to the relevant contents in the *Safety Manual*.



### **DANGER:**

When selecting to suspend Enabling Switch, the triggering effect of Enabling Switch will be disabled. Users must properly configure the speed limit, power and force limit, axis, and space limit by the risk assessment. Users must take responsibility and ensure the robot will have no chance of contacting the body regions of users. Operating the product without proper evaluation on risks, testing, and carefully reading the product's operating manual, this product would dump or pinch to the users, even causing life-threatening dangers. Failure to perform a proper risk assessment, the configuration of safety limits, or comply with the safety manuals may increase the risk of injury or death.

## 1.14.3 Speed & Force

On this page, users can set the limit values of Speed Limit functions and Force and Torque Limit functions in either Performance Safety Settings or Human-Machine Safety Settings.

### 1.14.3.1 General

- Users can set the limit values of Hand Guide TCP speed in either T1 MODE or TCH MODE by configurations of the MODE setting. The Hand Guide TCP speed limit functions only during hand guiding. If configured the MANUAL MODE to T1 MODE, the Hand Guide speed limit follows the limit value of the T1 Hand Guide speed limit. Alternatively, The Hand Guide speed limit follows the limit value of the TCH Hand Guide speed limit in TCH MODE.
- Users can set the limit values of the end-point reduced speed limit. This speed limit functions only in T1 MODE.
- Before performing the operations or the settings, read and follow the instructions in the *Safety Manual* for the associated physical explanation and the definitions of safety functions and the precautions.
- Users can refer to Appendix B: Tables of Safety Parameter Upper and Lower Bounds for the limit values applicable to each model.
- The default limit value of the stop criteria aims to provide a relatively safer working capability for the robot. Users can set a higher upper limit. If users want to reach 100%

project override speed without triggering these stop criteria, set the limit value to the upper limit for each input slot. Since the robot capability is associated with the pose, motion, TCP length, and payload, without these stop criteria, the robot is protected with the maximum allowable torque of each joint and stop. In addition, regarding the robot lifespan, refer to the *Hardware Installation Manual* of the respective model for the value of rated torque and the limit for repeated peak torque of each joint.

Note

**NOTE:**

While using with Hand Guide, users will feel the resistance feedback if the pull speed by hand reaches the Hand Guide TCP speed limit. Under such circumstances, lower the strength to pull to keep from triggering the protective stop.

#### 1.14.3.2 Performance Safety

- Users can set the speed limit values of safety tools and joints, the force limit values of TCP and elbow, and the torque limit values of the joints. These limits function under both AUTO MODE and MANUAL MODE. Before performing the operations or the settings, read and follow the instructions in the *Safety Manual* for the associated physical explanation and the definitions of safety functions and the precautions. Users can refer to Appendix B: Tables of Safety Parameter Upper and Lower Bounds for the limit values applicable to each model.

#### 1.14.3.3 Human-Machine Safety

- Once triggered by any Human-Machine Safety Settings function, the robot will run at a slower speed and a lower joint torque stop criteria. At this time, a purple light will be added to the Indication Light Ring for users to distinguish whether the robot is switching into Human-Machine Safety Settings.
- Users can set the speed limit value for safety tools and joints, the force limit value of TCP and elbow, and the torque limit values of joints for Human-Machine Safety Settings. Users can refer to Appendix B: Tables of Safety Parameter Upper and Lower Bounds for limit values applicable to each model.



**DANGER:**

Note that the functions described in this section are to assist users in setting the Human-Machine safety parameters and settings more conveniently only. Users should still perform a complete risk assessment according to the robot use environment and conditions before using the robot. TM Robot specifies the following potential residual

risks: There is a risk that causes the robot to hit a human body at full speed due to improper use of safety settings or by running incorrect projects.



**DANGER:**

When using the Compliance function in **TMflow**, speed is not under control in **Human-Machine Safety Settings**. The robot will still run the **Compliance** function by the force users set. If you want to use the **Compliance** function with **Human-Machine Safety Setting**, complete a full risk assessment and set appropriate force values.

- This function also provides a **Quick Setting by choosing body contact regions**. Users can set the human body region that may be in contact with the robot in the collaborative workspace according to the requirements. The calculation result includes the limit value of the speed limit of the safety tool. Users must check the confirmation field at the right side before confirming the area where the external device of the robot may be contacting the human body larger than or equal to the area confirmation value. This feature is designed for users to quickly set up an initial robot application in the collaborative workspace following the biomechanical limits of each body region listed in ISO/TS 15066. Users should still perform a risk assessment on real applications before deployment. Users should take responsibility for the human body region not listed in this graph and ensure the robot does not have any chance of contacting any vulnerable body region such as the spine and hindbrain.
- For the detailed test of initial parameters, refer to the relevant contents in the *Safety Manual*.



**DANGER:**

This function follows the biomechanical limits of each body region in ISO/TS 15066, and it designs to adjust the robot speed automatically in the collaborative workspace. Users should consider more and take responsibility for human body regions not listed separately in the graph by themselves. Also, make sure that the robot does not have any chance of contacting any particularly vulnerable body region like the spine, neck, or head.



**DANGER:**

The Human-Machine Safety Settings functions provide users with a quick and initial robot application in a collaborative workspace following the biomechanical limits of each body region listed in ISO/TS 15066. Though users can further adjust the limit values of the speed limit of safety tools and joints, force limit of TCP and elbow, users should still

perform a risk assessment on real applications before deployment. Also, note that users should take responsibility for the human body region not listed in this graph and ensure the robot does not have any chance of contacting any vulnerable body region such as the spine and hindbrain.

#### 1.14.4 Soft Axis

On this page, users can set the limit values of Soft Axis Limit functions for Joint Position Limit, Cartesian Limit A, and Cartesian Limit B. Also, users can set default and additional Soft Axis Settings for users to switch between different pre-defined Soft Axis Settings.

##### 1.14.4.1 Default & Additional

- Users can set the limit values of Soft Axis Limit functions for Joint Position Limit, Cartesian Limit A, and Cartesian Limit B in the default and the additional of the Soft Axis Settings switched by an external safety input. Before performing the operations or the settings, read and follow the instructions in the *Safety Manual* for the associated physical explanation and the definitions of safety functions and the precautions.

##### 1.14.4.2 Joint Position Limit

- Users can set the limit values of the position limit of joints. These limits function under both AUTO MODE and MANUAL MODE. Before performing the operations or the settings, read and follow the instructions in the *Safety Manual* for the associated physical explanation and the definitions of safety functions and the precautions. Users can refer to Appendix B: Tables of Safety Parameter Upper and Lower Bounds for limit values applicable to each model.



**CAUTION:**

For different TM Robot models the maximum angle limits of each joint may vary. Refer to the product specifications according to the product model and hardware version.

##### 1.14.4.3 Cartesian Limit A & Cartesian Limit B

- Users can set the limit values of the position limit of the safety tool. These limits function under both AUTO MODE and MANUAL MODE. Cartesian Limit A and Cartesian Limit B are available as a cube or a cylinder to set the bounds for the safety tool of robot movement. Any violation to the plane from the safety tool and/or the elbow

will result in a Category 2 stop for Cartesian Limit A while triggering Human-Machine Safety Settings in Cartesian Limit B. For **Cube** or **Cylinder**, continue to check the desired axis bounds and input the integer values of the desired distance in millimeters. Be sure to make the difference between the upper bound and the lower bound beyond 120 mm.

- Before performing the operations or the settings, read and follow the instructions in the *Safety Manual* for the associated physical explanation and the definitions of safety functions and the precautions. Users can refer to Appendix B: Tables of Safety Parameter Upper and Lower Bounds for limit values applicable to each model.

#### 1.14.5 Safety IO

On this page, users can set the input and output functions of the safety functions. Users can also assign the safety input and output to the desired safety functions.

##### 1.14.5.1 Input Functions

- **Input Discrepancy Detection Time:** The input discrepancy detection time by different safety functions and different external devices available to be configured.
- **Manual Reset (recommended):** For **Manual Reset**, once the robot is latched in the safety status of Safeguard Input or Safeguard for Human-Machine Safety Settings Input, whether the trigger condition has detached, users must manually trigger the Reset function for the robot recovery from the latching safety status. Send an additional **Play** command to return to the original project process and the project speed.
- **Auto Reset:** For **Auto Reset**, once the robot is latched in the safety status of Safeguard Input or Safeguard for Human-Machine Safety Settings Input, once the trigger condition has detached, the robot will automatically recover from the latching safety status and return to the original project process and project speed.
- For the definitions of the safety functions and the precautions, read and follow the instructions in the *Safety Manual*, then proceed with operating or configuring the settings.
- **Suspend External Safeguard Input under MANUAL MODE:** Enable this function to suspend Safeguard functions under MANUAL MODE. Users are still under the protection of Enabling Switch functions and other safety functions with proper safety settings use.

#### 1.14.5.2 Output Functions

- **Output Port Setting:** The output ports provide configuration of output behavior to follow **Robot Status (Recommended)** or **Input Status** for different cases. Users should take the external machines or the receiving devices into consideration of the output behavior configuration. For the definitions of the safety functions and the precautions, read and follow the instructions in the *Safety Manual*, then proceed with operating or configuring the settings.
- **Safe Home Output Port Setting:** Users can set the safe home pose of each joint angle and its tolerance according to application. For the details of this safety function, refer to the relevant contents in the *Safety Manual*.

#### 1.14.5.3 Input Ports & Output Ports

- **Input Port Assign:** There are eight dual-channel input ports for users to use. The first two input ports fix over SF1 User Connected ESTOP Input and SF3 User Connected External Safeguard Input. Some input functions, including SF15 User Connected Enabling Switch Input, SF25 User Connected MODE Switch Input, SF26 User Connected Reset Input, and SF27 User Connected Soft Axis Settings Switch Input, can be configured but do not allow for duplication.
- **Output Port Assign:** There are eight dual-channel output ports for users to use. All the output functions can be configured and allow for duplication. Select to enable the **Diagnostic Signal (OSSD)** of each output port by application.
- For the electrical connections of the **Safety Input Connector** and the **Safety Output Connector**, refer to the relevant sections of the *Hardware Installation Manual* with the respective hardware version.
- For the definitions of the safety functions and the precautions, read and follow the instructions in the *Safety Manual*, then proceed with operating or configuring the settings.

#### 1.14.6 Safety Tool

On this page, users can set the necessary safety tool point and additional safety tool points referenced from the center coordinates of the flange. The system will monitor these safety tool points with Speed Limit and Soft Axis Limit functions. Select up to 8 additional safety tool points to enable by application. Users can refer to Appendix B: Tables of Safety Parameter Upper and Lower Bounds for setting values applicable to each model.

**WARNING:**

When setting the TCPs, it is necessary to consider these TCPs within the range of safety tool points. Users must properly configure the safety tool points to cover all the possible TCPs used. Users must take responsibility and include the TCPs within the range of safety tool points. Failure to perform a proper risk assessment or the safety configuration or failure to comply with the safety manuals may increase the risk of injury or death. For details of the monitored safety end-points by the different limit functions, refer to the respective system version of the *Safety Manual*.

### 1.14.7 Mounting Direction

On this page, users can set the mounting direction of the robot. There are three-angle setting values of the base frame concerning the gravity (G) about to set. The **Reference from G-sensor values** provides the values read from the gravity sensor of these three angles. Users should set proper setting values according to the application. Improper values with a mounting direction may result in the robot moving with unexpected motion and further hitting a human body.

**DANGER:**

Note that the mounting direction setting described in this section applies to the motion-related and the Force and Torque Limit functions. Users should set proper setting values and make sure the values meet the substantial mounting form by the application before using the robot. TM Robot specifies the following potential residual risks clearly: There is a risk that causes the robot to move with unexpected motion or hit a human body due to improper setting values in the mounting direction.



## Start Your First Project

### 1.15 Overview

This chapter describes how to create and run your first project. Before performing the instructions given in this chapter, please be sure to read all the instructions, gain a full understanding of the content of this manual, and correctly set the TM Robot according to Chapters 2 and 3.



#### **IMPORTANT:**

Before starting using the robot, make sure to carry out all the initial tests and examinations listed below:

1. The functional testing of Emergency Stop functions
2. The functional testing of Safeguard functions
3. The functional testing of Enabling Switch functions
4. The functional testing of Force and Torque Limit functions
5. The functional testing of Speed Limit functions
6. The functional testing of Soft Axis Limit functions
7. The functional testing of Safety Output functions

The robot and the system should perform either Category 1 Stop or Category 2 Stop concerning these different safety functions. For details about the stop categories, trigger and resume method of the safety functions mentioned above, see the corresponding safety system version of the *Safety Manual*.

Before starting the first project, make sure that the **Safeguard for Human-Machine Safety Settings Input** is OPEN and the robot is in the **Human-Machine Safety Settings** state (as happened when the **Indication Light Ring** of the **End Module** is flashing purple. For details, see the section of Safety Connection in corresponding hardware version of the *Hardware Installation Manual*.

### 1.16 Initial Setting

When your device is connected to the TM Robot for the first time, follow the wizard steps to complete the following settings:

- Step 1.** Follow the steps to set up the robot.
- Step 2.** Select the interface language.
- Step 3.** Set the system time.
- Step 4.** Complete the Network settings.
- Step 5.** Perform voice settings.

To reset the robot, navigate to  and click **Setting > Wizard**.

### 1.17 M/A Mode and FreeBot

Confirm the **Operation Mode** of the robot at this time. Check the **MODE Indicator** on the **Robot Stick**, and identify whether the lamp position is marked as **M** (MANUAL MODE) or **A** (AUTO MODE). The **Operation Mode** can also be identified by the **Indication Light Ring** of the **End Module**, where green light is **MANUAL MODE**, and the white light is **AUTO MODE**. If it is still in **AUTO MODE**, refer to the **MODE switch function** in Chapters 2 to switch to the **MANUAL MODE** to perform the follow-up operations of this chapter. When the **MODE Indicator** lamp position at **M** and the **Indication Light Ring** of the **End Module** is green, it is in **MANUAL MODE**.

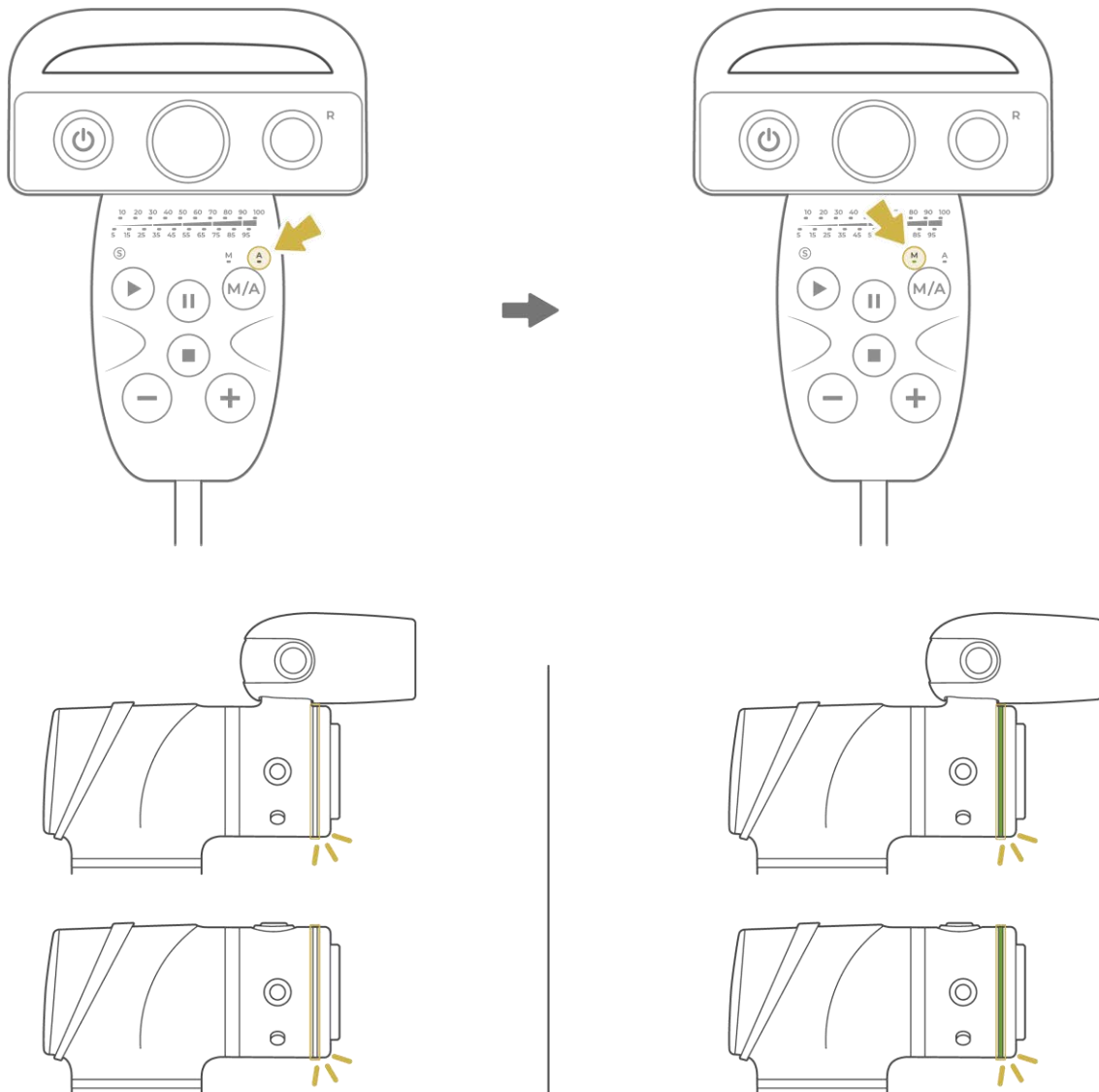

Figure 4 - 1: AUTO MODE / MANUAL MODE

In **MANUAL MODE**, users can press the **FREE button** to hand guide the robot. The hand guiding function is limited to **MANUAL MODE**.

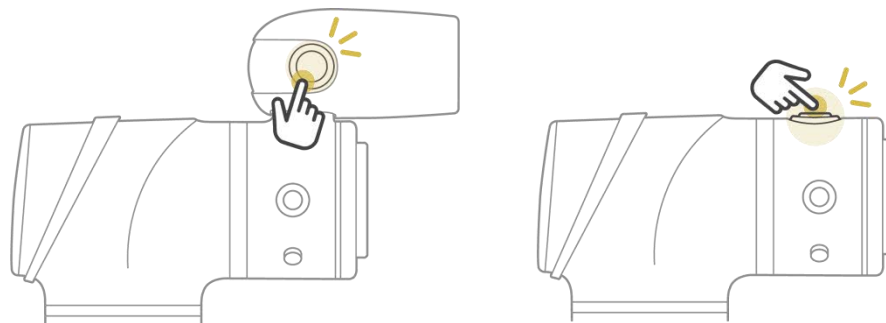

Figure 4 - 2: FREE Button



**IMPORTANT:**

Make sure the robot stays still, and no extra force applies to the external force sensor, such as touching the tool or the external force sensor by hand, before releasing the FREE button. If releasing the FREE button while the robot is moving, the robot might vibrate or hop for the brake, which may result in errors on joints in the extreme conditions.

### 1.18 Build and Run the First Project

If this is the first time of unpacking the TM Robot, there will be no project in the robot. Users can build the first project by the instructions given in this section.

TMflow has two programming methods: Flow and Script. Users can choose either one of them as the first project. The flow is a graphical programming interface developed for TM Robot. Users can start quickly and intuitively build a project by dragging the modularized nodes without any programming experience or writing additional codes. The script is a program editor for experienced users with writing scripts. Users can write programs of the robot motion logic with the rich tools and library provided in the script editor.

The following project aims to run back and forth between two points (P1 and P2) as steps described below:



**CAUTION:**

Before performing the instructions given in this chapter, please be sure to read all the instructions, gain a full understanding of the content of this manual, and correctly set the TM Robot according to Chapters 2 and 3,

- Step 1** Confirm the **Operation Mode** of the robot. If it is not in **MANUAL MODE**, use the MODE switch function to switch to **MANUAL MODE**.
- Step 2** Navigate to ≡, and click **Project** to enter the **Project Editing Page**.

**Step 3** Choose to create a new project and enter the project name.



**IMPORTANT:**

The project naming supports the Latin alphabet in upper and lower case (A~Z and a~z), numbers (0~9), and underscores (\_). The naming must go with an underscore or an alphabet in upper or lower case and without a number as the first character.

**Step 4** Enter the project name. The maximum number of characters for naming a project is 100.

**Step 5** Press and hold the **FREE** button to move the robot to any point by hand guiding and press the **POINT** button to let the project flow generate the point. Users can see that the robot automatically names this point as P1 and has been automatically added after the Start Node and automatically highlighted.

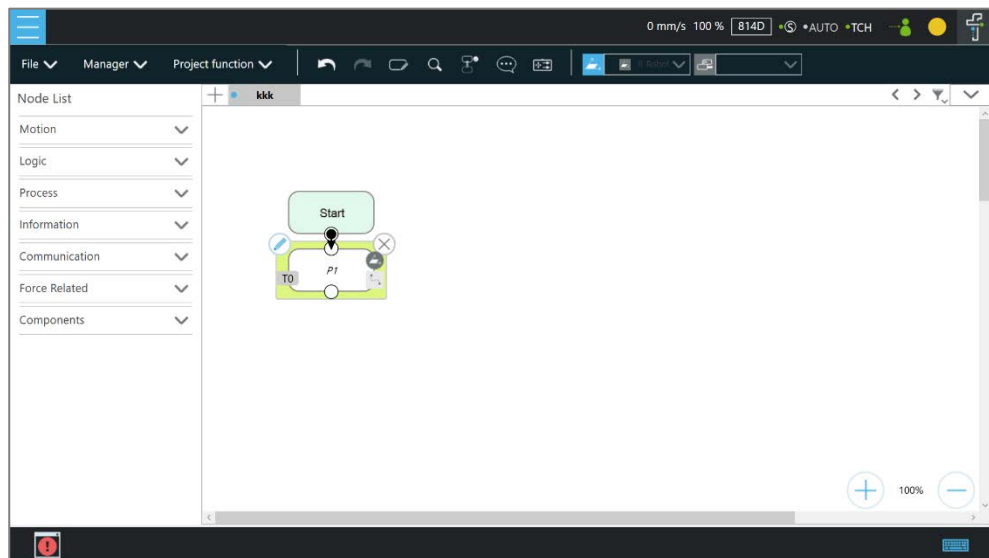

Figure 4 - 3: Build and Run the First Project (1/6)

**Step 6** Press the **FREE** button and move the robot to any other point by hand guiding. Press the **POINT** button to record this point and generate P2.

**Step 7** For a flow project, drag a **Goto** Node from the nodes menu and drop it onto the project flow. Click the pencil icon and select **Set Goto Target**. Then choose P1.

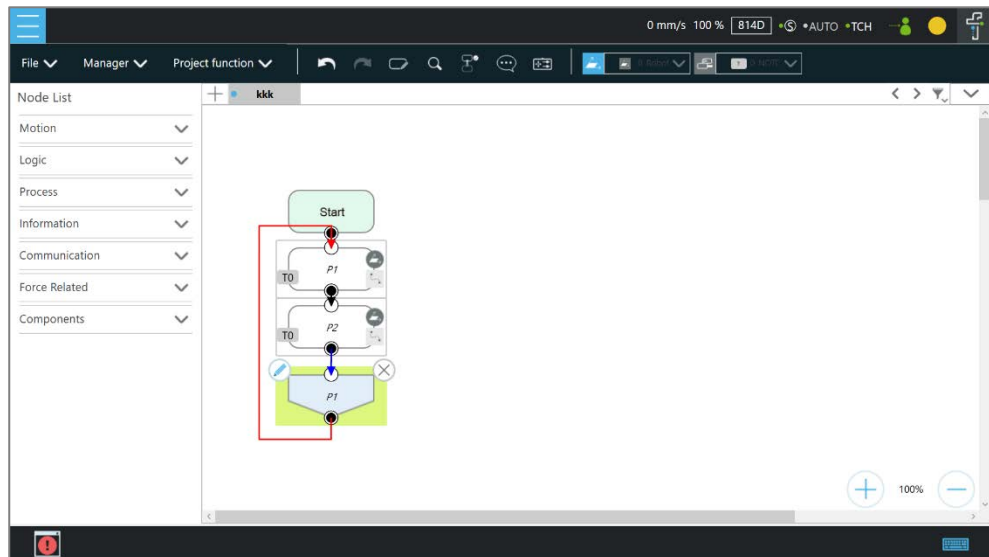

Figure 4 - 4: Build and Run the First Project (2/6)

For a script project, use a while loop to repeat the motion.

**Step 8** Navigate to **File** and click **Save**.

**Step 9** Hold the **Enabling Switch** on **Robot Stick** and press the **Play** button on the **Robot Stick** in the **Project Editing Page** to start running the project. At this time, the **Indication Light Ring** will flash in green. Each time users start running a project in **MANUAL MODE**, the **Robot Stick** looks as shown.

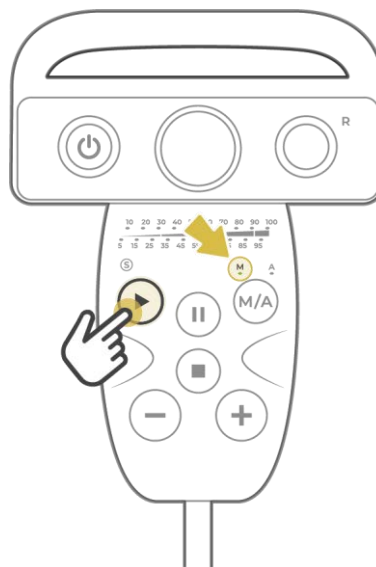

Figure 4 - 5: Build and Run the First Project (3/6)

**Step 10** In the trial run, the process speed of the project will start at initial speed of 5% as shown on the top right of the **Project Editing Page**.

**Step 11** Press the **+** button or the **-** button on the **Robot Stick** to increase or decrease the project override speed of the robot. Adjust the speed of the robot at this time for an appropriate rate. (Users can read the project override speed from the % number displayed at the top right of the operation interface.) Note that the rate will always be limited to less than 250 mm/s under the **T1 MODE**, and users cannot record the speed under this MODE. For **TCH MODE**, users will have to press and hold the **+** button to unlock the speed adjustment first. Then, users can adjust the project override speed and set the rate higher than 250 mm/s.

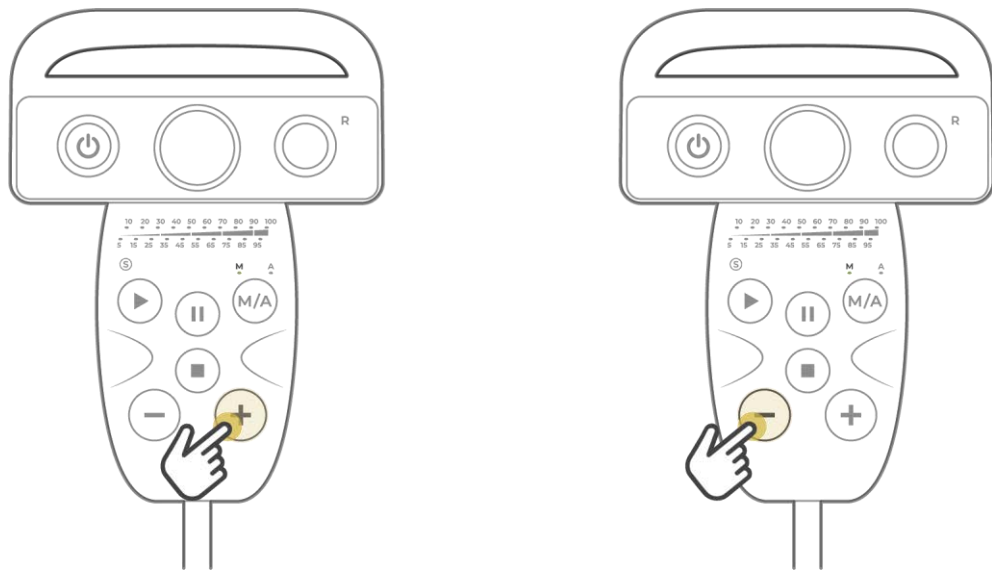

Figure 4 - 6: Build and Run the First Project (4/6)

**Step 12** After confirming the preferred project, press the **Stop** button on the **Robot Stick**. Use the **MODE** switch function to switch to **AUTO MODE**. The page will jump to **View** page.

**Step 13** Press the **Play** button on the **Robot Stick** in **AUTO MODE** to start running the project. The project override speed remains at 5%. At this time, the **Indication Light Ring** will flash in white. Each time users start running a project in **AUTO MODE**, the **Robot Stick** looks as shown.

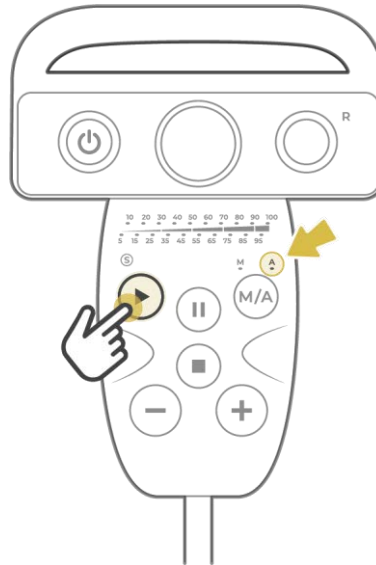

Figure 4 - 7: Build and Run the First Project (5/6)

**Step 14** Press the **+** button or the **-** button on the **Robot Stick** to increase or decrease the project override speed of the robot. Adjust the speed of the robot at this time for an appropriate rate. After setting the preferred project override speed, press and hold the **Play** button to record the project override speed.

**Step 15** Press the **Stop** Button on the **Robot Stick**, and go to the **Run Setting** page to check the current project with preferred recorded project override speed. The project will always start with the project override speed labeled in **Run Setting** page under **AUTO MODE**. To record the project override speed again, users can perform the previous steps again or set the initial project override speed in Start Node.



Figure 4 - 8: Build and Run the First Project (6/6)

**Step 16** Congratulations on the successful completion of project editing and running. Users can now switch over to **MANUAL MODE** and start creating another project.



**WARNING:**

Running a self-built project before completing adequate training may lead to body collision or human injuries due to unforeseen robot actions.

### 1.19 Project Override Speed

This section introduces the project override speed by different operation modes. The table below summarizes the project override speed adjustment and the recording method.

MODEs	Project Execution	Project Override Speed	
		Adjustment	Record
MANUAL (T1)	Project verification is available with users holding <b>Enabling Switch</b> on Robot Stick continuously at ON Status and a <b>Play</b> button.	Available with + button / - button limited the speed within 250 mm/s.	Unavailable
MANUAL (TCH)	Project verification is available with users holding <b>Enabling Switch</b> on Robot Stick continuously at ON Status and a <b>Play</b> button.	Press and hold the + button to unlock the speed adjustment. Available with + button / - button not limited the speed within 250 mm/s	Unavailable
AUTO	Project execution is available while AUT.P is in Close Status and a <b>Play</b> button.	Available with + button / - button.	Available with press and hold the <b>Play</b> button during project execution. Users can reset the project override speed in the Start Node.

Table 4: Project Override Speed Adjustment and Record Method

### 1.20 Shutdown

There are two methods to shut down:

Method 1: In **TMflow**, navigate to , click **Shutdown**, and choose **Shutdown**. When the warning message appears, click **OK** to shut the system down properly.

Method 2: Press and hold the **Power** Button of the **Robot Stick**, and release the button after 3 seconds. The Power Indicator of the **Robot Stick** will turn off and the system performs shutdown.



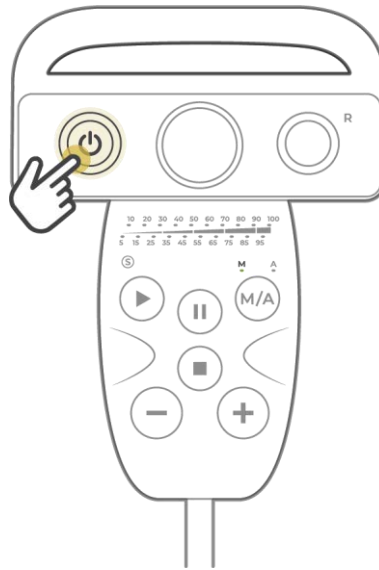

Figure 4 - 9: Shutdown



**DANGER:**

Do NOT use the following Shutdown methods:

1. Removing the power plug directly,
2. Unplugging the power cord of the **Control Box** directly, or
3. Unplugging the power of the robot body directly.

## Operation Interface

### 1.21 Overview

The chapter will introduce the operation interface of **TMflow**, including the icons in the function menu: **Login/Logout**, **Connect**, **View**, **Run Setting**, **Project**, **Configuration**, and **System**.

Navigate to ☰ and click to expand the function menu. The listed icons from top to bottom are:

- **Login/Logout**: login/logout to start/stop using the robot
- **Connect**: list the available robots
- **View**: display page when the project is running
- **Run Setting**: project list and the default project to run
- **Project**: create or edit the project
- **Configuration**: set all the equipment that makes up the system to operate
- **System**: set the preference of the system
- **Shutdown**: turn off the system

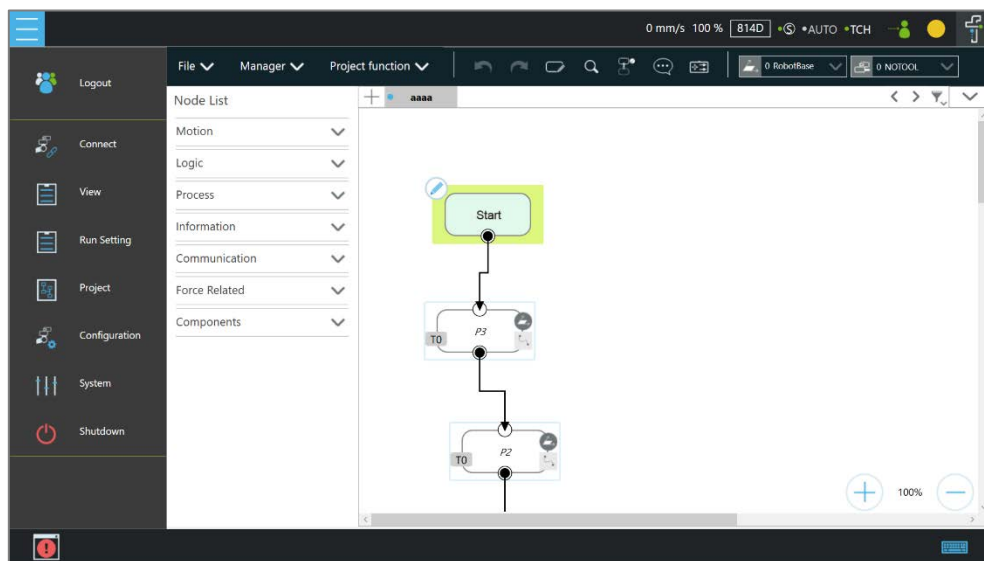

Figure 5 - 1: Function Menu

#### Note

#### NOTE:

- When connected from a client device, there is another icon, **Leave**.
- The selection is available when the mouse cursor moves onto the immediate vicinity of the icon or the text in the function menu.
- The log of the last 24 hours presents at the right of the operation interface after the system rebooting.

### 1.22 Login/Logout

The login window will pop up when clicking **Login**. Enter the account and the password to start using

the robot.



**CAUTION:**

The default account is **administrator**, and the default password is blank.

Refer to Chapter 0 for details, from start up to complete login: Start up and Activation.

## 1.23 Connection

### 1.23.1 Local Connection

To control the robot with the screen, keyboard and mouse via the Control Box or the touch screen via the display module, follow the instructions below to log in and connect. After completing login, click **Get Control** as shown below to control the robot. To release the control to the robot, click **Release Control**. Refer to Chapter 2 for the details.

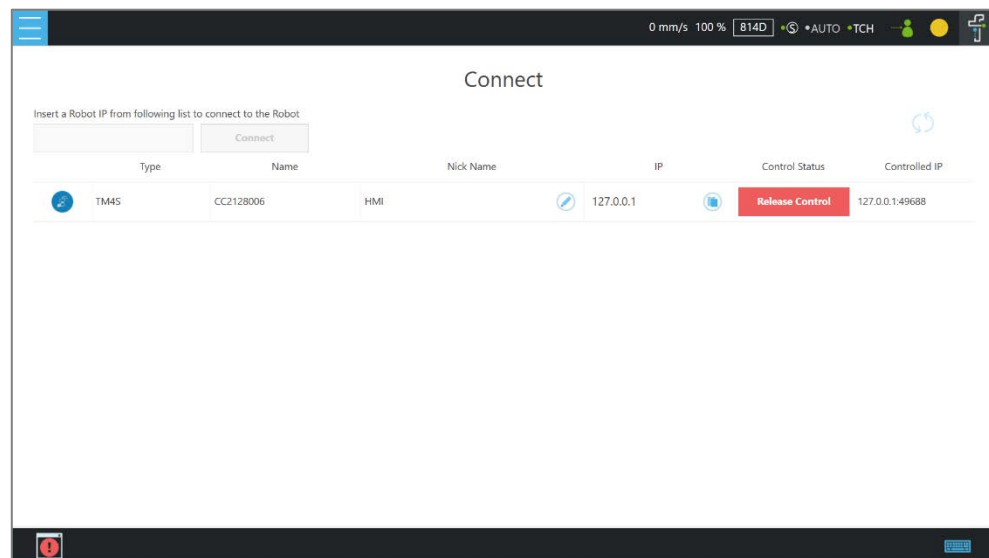



Figure 5 - 2: Get/Release Control (Local)

### 1.23.2 Remote Connection

To control the robot from a remote device (desktop, laptop, or tablet), follow the instructions below before login. Click the upper left corner  to refresh the robot list. Available robots will be displayed with their types, names, nick names, IP addresses, and control status in the list. Click the available robot's IP address and click **Connect** to bring up the Login pop-up window to login. Click the **Get Control** button below the robot to get control. To release the control, click **Release Control** again. Refer to Chapter 0 for details. A warning message will prompt users to

use the same version of TMflow for connection if the versions between the client and the host are different.



**NOTE:**

The addresses of **Modbus Slave**, **EtherNet/IP Adapter**, **PROFINET IO Device**, and **Ethernet Slave** for robot stick commands (Play/Pause, +, -, Stop) cannot be written to when the robot is in Manual Mode or when users get control permission in Auto Mode.

### 1.24 View

In the view page, users can monitor project progress and the robot, as the figures below from left to right are **Display Board**, **Flow**, **IO**, **Simulator**, **Status**, **Actioner**, and **Force Sensor**.

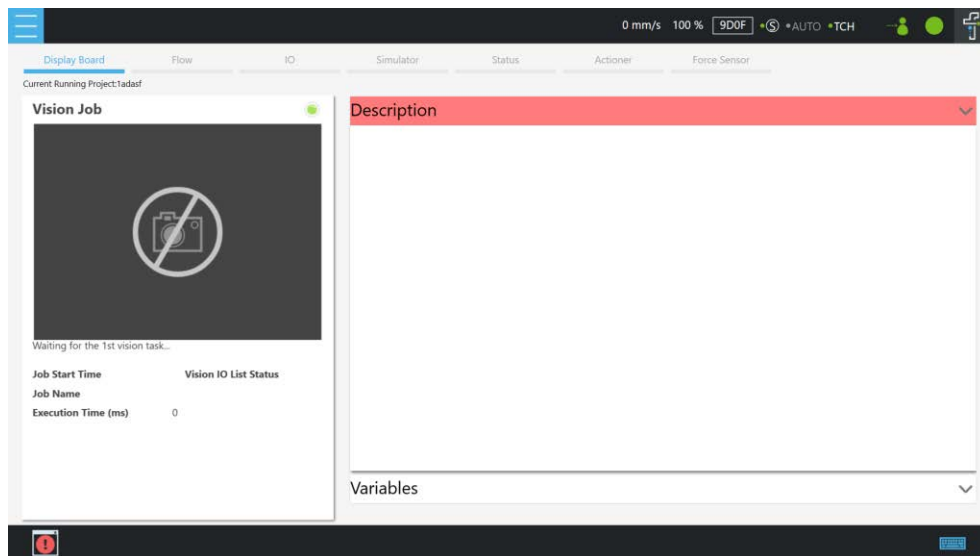

Figure 5 - 3: View

For **Force Sensor**, refer to 1.54.4 Force Value and Charts.



**IMPORTANT:**

The robot provides remote and local multi-logins, but only one person can get control at a time.

#### 1.24.1 Display Board

In **Display Board**, users can monitor the project running status such as the vision job result at left and the status display at right. Users can click on the Down Arrowhead icon at the top right to switch the status display of descriptions and variables. The description content can be changed through the **Display** node, and the variable can be changed through the **Display Management**

in the project.

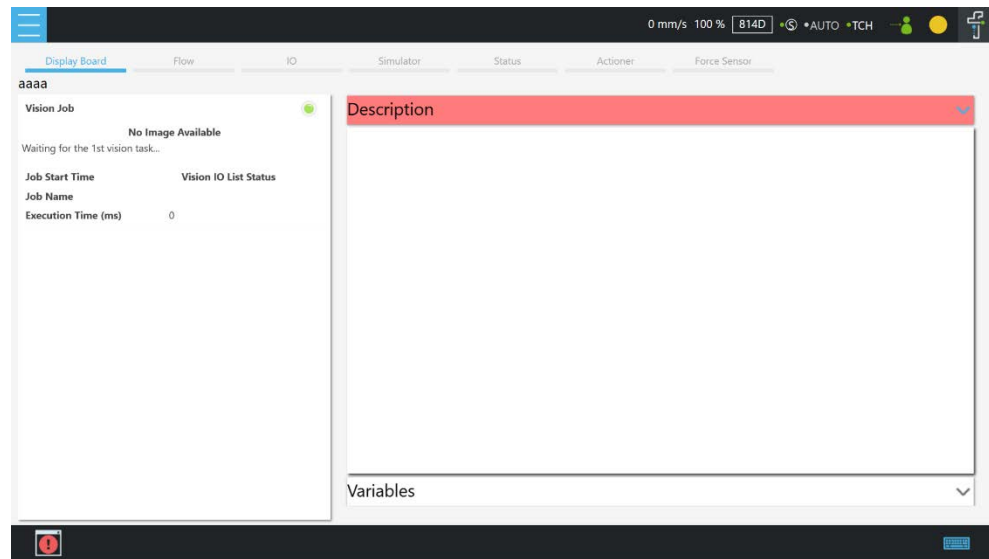

Figure 5 - 4: Display (1/3)

Once the robot is in auto mode, users can see the page for speed adjustment password input after clicking the variable button.

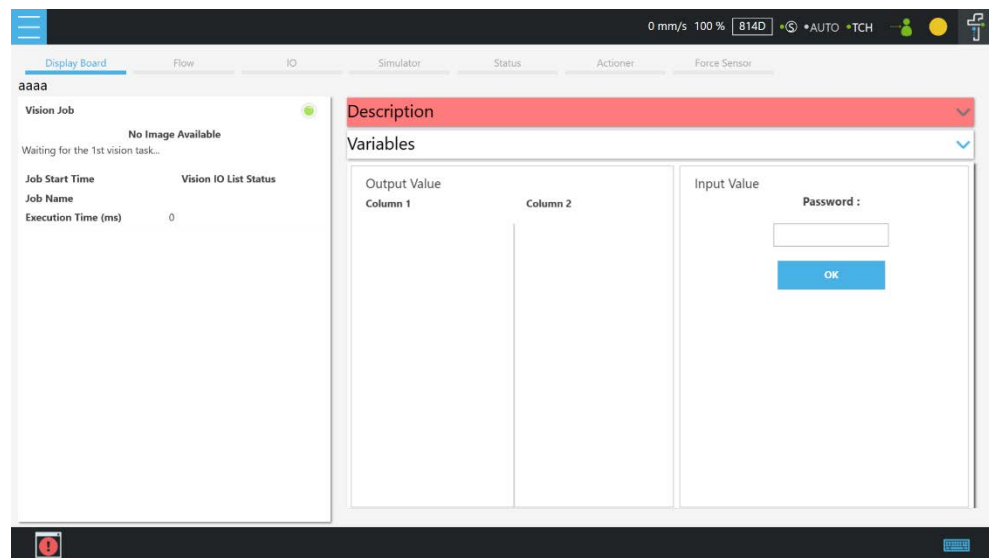

Figure 5 - 5: Display (2/3)

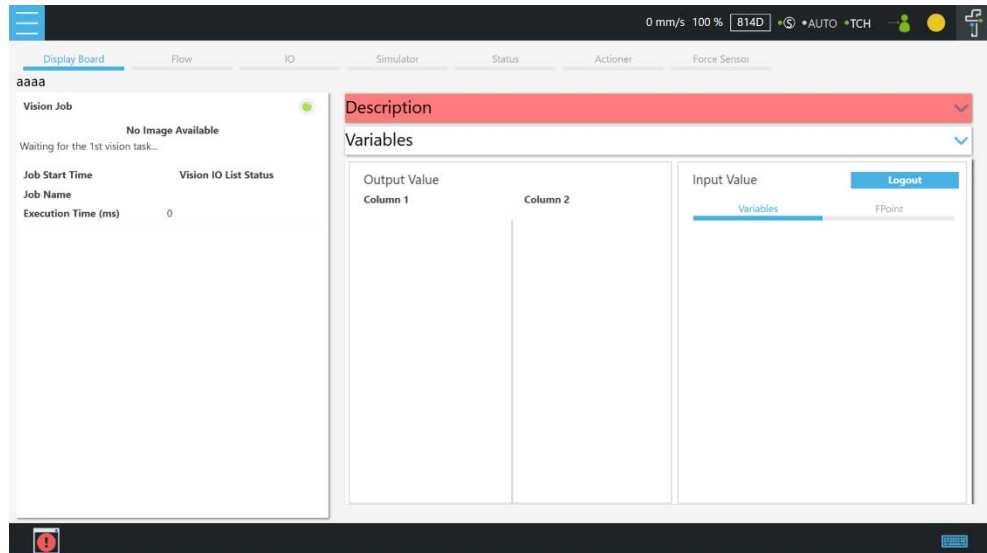

Figure 5 - 6: Display (3/3)

Note

**NOTE:**

When an error occurred:

- In Manual mode
  1. The system will return to the **Project Editing Page**, highlight the node induced the error, and expand the system log with the error code.
  2. If there is no account currently logged in or the logged in account does not come with the privilege to open the project, the system will not return to the **Project Editing Page** but expand the system log with the error code.
  3. The contents in the Display Board does not go away even if users go back the **Project Editing Page** until the project runs again.
  4. The system log does not fold up automatically.
- In Auto mode
  1. The system log expands at right and the **Flow** menu on the top left becomes accessible.
  2. Users can click **Flow** to generate the project flow with the node induced the error highlighted. If the flow did not induce the error, the highlight is on the last executed node.
  3. The system displays the page induced the error only and highlights the node induced the error.
  4. Users can switch to Manual mode to correct the node induced the error with the function menu or press the **Play** button of the robot stick without correcting to make the **Flow** button gray out and the system log fold up automatically.

### 1.24.2 Flow

In **Manual Mode**, the flow will be displayed with the focus on the current processing node while the project is running. Switch off the Auto Focus-Tracking icon at top right to scale the flow with

the + and the - button at bottom right. Through this page, users can conveniently monitor the process as well as properly optimize and modify the process. In **Auto Mode**, this page will not display.

### 1.24.3 IO

**IO** provides IO status monitoring and operation tools for users to monitor the status of the digital/analog input and to operate the digital/analog outputs in this page. When the project is running, the IO is controlled by the project and cannot be changed manually.

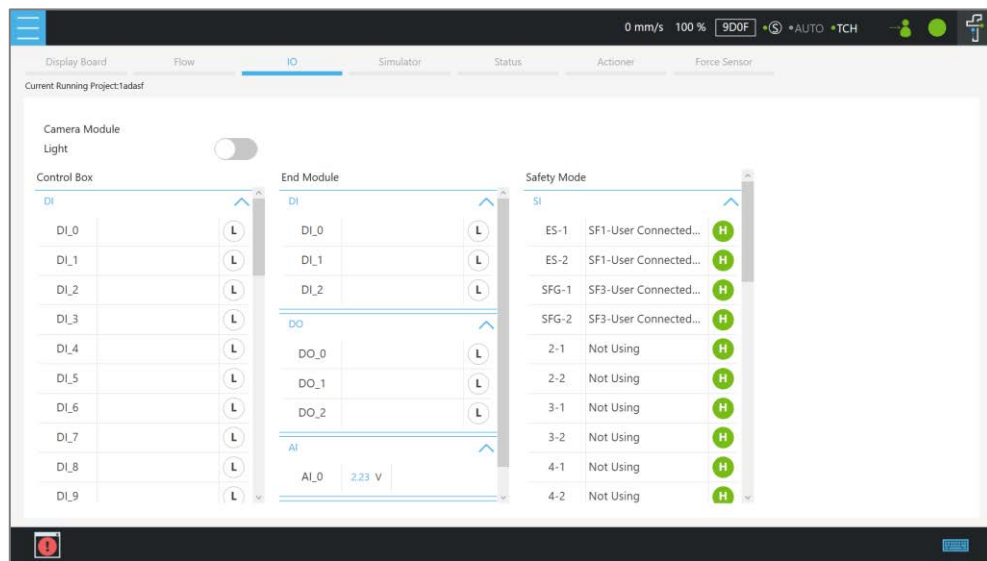



Figure 5 - 7: IO

### 1.24.4 Simulator

In Simulator, users can monitor the current robot posture. Press and hold Ctrl on the keyboard and, with the right button of the mouse depressed, rotate the 3D model by dragging the mouse. Press and hold Ctrl and, with the left button of the mouse depressed, zoom in and out of the 3D model by dragging the mouse up or down. Press and hold Ctrl and, with the middle button depressed, move the 3D model by dragging the mouse. Press the  icon on the screen to scale the sight of view to a proper size. The information of the Joint Angle and TCP Coordinate status of Robot base is at the right.



**NOTE:**

If the mouse comes with a scroll wheel, it is the middle button. If neither the mouse comes with the middle button, nor the scroll wheel, users can press the left and the right buttons simultaneously to function as the middle button.

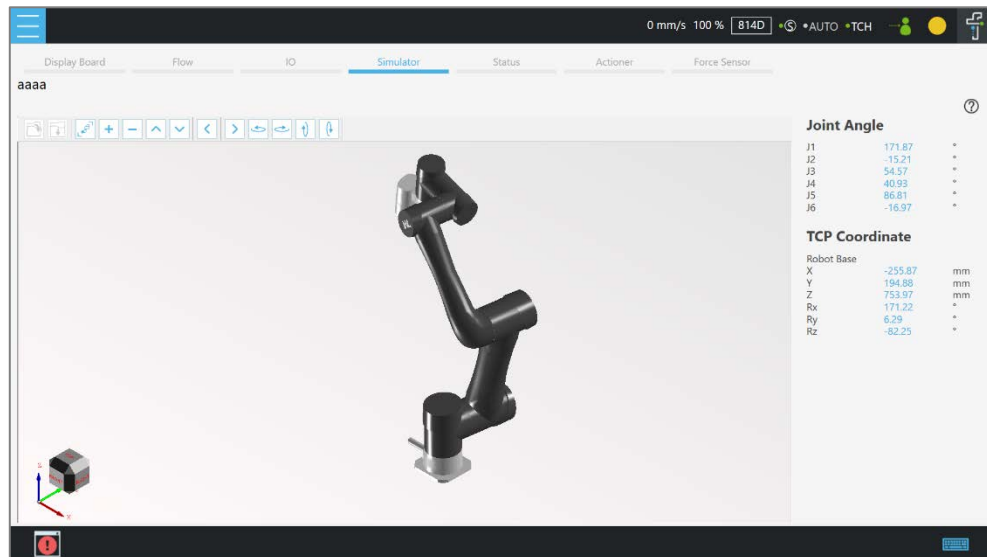

Figure 5 - 8: Simulator

**Note**

**NOTE:** The **Simulator** page is unseen when the local control box is in Auto Mode. Users can bypass the restriction by logging in the robot with a remote TMflow Client to view the **Simulator** page.

### 1.24.5 Status

In **Status**, users can monitor the status of **Controller Temperature**, **Robot Voltage**, **Robot Power Consumption**, **Robot Current**, **Control Box I/O Current**, and **Tool Side I/O Current**. The currently running project or the preset project is at top left, and the performance of the service is at the bottom left if enabled.

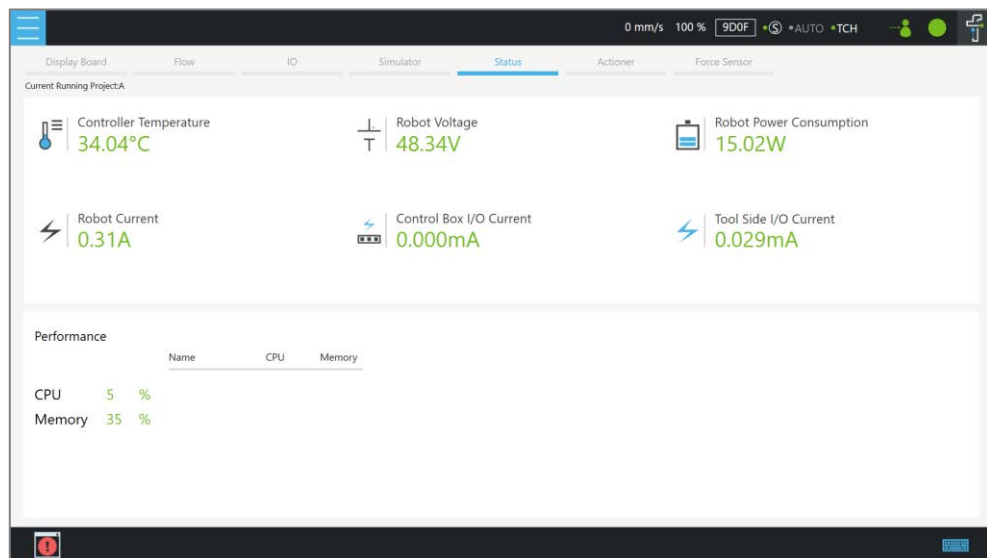

Figure 5 - 9: Status



### 1.24.6 Actioner

In **Actioner**, users can check results, images, and variables ended up with the vision job. While the project is running, this page stays at which the current vision job finished and keeps updating, and users can pause the project and check with the finished vision job in the meanwhile. When the project is stopped, information of the vision job and images remain in **Actioner** until the next project execution. **Actioner** is available in Manual Mode, Auto Mode, and TMflow client.

The resolution in the **Actioner Live Video** is 640\*480. If the system comes with the external SSD, users can use the magnifier to enlarge the selected region on the **Live Video** for 1, 2, or 4 times. The magnifier is not available if no external SSD is presented or not checked **Save Source Image** in **Save Job > Save Image Setting** of the vision job.



#### NOTE:

- If the variable outputs more than the available length in **Actioner**, users can move the cursor on the variable and the system will prompt its entire content.
- Use the slider for the outputs beyond the available viewing area.



#### IMPORTANT:

The TM SSD is a requisite for using **Actioner** with TM 3DVision to check images.

### 1.24.7 Force Sensor

Refer to 1.54 F/T Sensor for instructions.

### 1.25 Run Setting

In **Run Setting**, users can view all the executable projects in the list. From left to right, the **Current** running project is in green, followed by the project **Name**, the project override **Speed** in **AUTO MODE**, **Status**, **Build date**, **Last updated date**, and **Last execution date**. For details about the recording of project override speed, refer to Chapter 1.18 Build and Run the First Project. Remember that the project override speed will start with the initial pace at 5% if running the project under **MANUAL MODE** again.

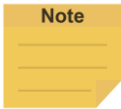

**NOTE:**

- The **Last execution date** is updated when users press Play and execute the project successfully and is not updated if they encounter errors.
- The **Build dates**, the **Last updated date**, and the **Last execution date** transfer along the project **Import/Export** to another robot.

### 1.26 Project

As shown below, the status column comes at the top. Users can navigate to and click **Project** to start creating and editing the flow. The status column goes from left to right along with a number with mm/s that suggests the TCP speed, a percentage that indicates the project speed, a safety checksum<sup>1</sup>, the robot stick mode indicator<sup>1</sup> (The bullet at left in green donotes enabled, and, gray, disabled.), the operation mode indicator (automatic or manual with T1 or TCH), the operation mode indicator<sup>2</sup>, the robot state indicator<sup>3</sup>, and the TMflow verison information.



**Note:**

1. Refer to the Safety Manual of the respective Safety System for details.
2. : your device controls the robot, : no one controls the robot, : another device controls the robot.
3.
 

Motion Available or In Motion	Recovery Mode	No Power To Robot
Motion Unavailable	Error Occurred	

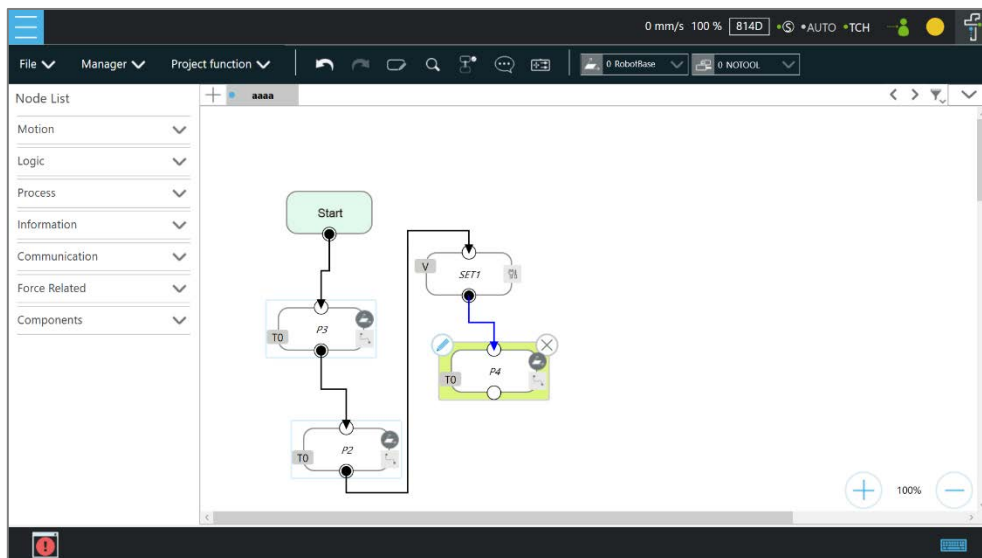

Figure 5 - 10: Project Editing Page

#### 1.26.1 Project Editing Toolbar

The project editing toolbar is located at the top of the **Project Editing Page**.

Main	Function	Flow Project	Script Project
File	Create New Project	✓ (1.26.1.1 A Create New Project)	
	Save Project	✓ (1.26.1.1 B Save Project)	
	Open Project	✓ (1.26.1.1 C Open Project)	

### 1.26.1.1 File

#### A. Create New Project

Click **File > Create New Project** to create a flow or script project. The project naming supports the Latin alphabet in upper and lower case, numbers, and underscores. The naming must go with an underscore or an alphabet in upper or lower case and without a number as the first character. The maximum number of characters can be used in naming a project is 100.



**NOTE:**

Check **Component Editor** to create components. Refer to 0 TM Component Editor for details.



**IMPORTANT:**

When saving the file, if there is a file with the same filename, it will be overwritten. Save the file with care to avoid file loss.

#### B. Save Project

Click **File > Save Project** to save the current project. The project is saved with the date and the time of build and last updated. If the previous project is not closed properly, a message will prompt when the project is opened. If select **Yes**, the last saved file version will be opened and all subsequent modifications will be discarded. If select **No**, the file will open with the last state before closing, and for users to perform the file saving operation.



**NOTE:**

- Before saving the current project, a warning message will prompt users to preserve the current project if changing the project at editing or switching to Auto Mode. Click **Yes** to save and close the project, **No** to simply close the project, or **Cancel** to ignore the message.
- If the message prompts after switching to Auto Mode, users must click **Yes**, **No**, or **Cancel** before proceeding.

### C. Open Project

Click **File > Open Project** to open existing projects. Projects are listed with the build date and the modified date. Users can sort projects in the list with the buttons of reverse alphabetical, alphabetical, or chronological. Click the **Batch Delete** button to select multiple projects to delete. Click on the name of the project to select the project to delete. Repeat the step if there are more projects to delete or check the box next to **Select all** to select all projects, and click **Delete** button to delete the projects. Click the **X** icon on the top right to exit.

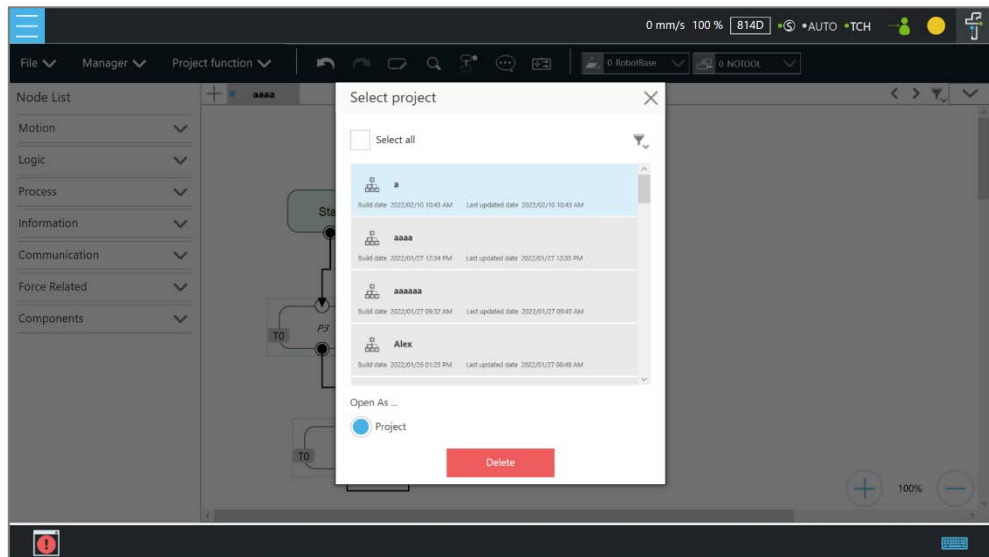
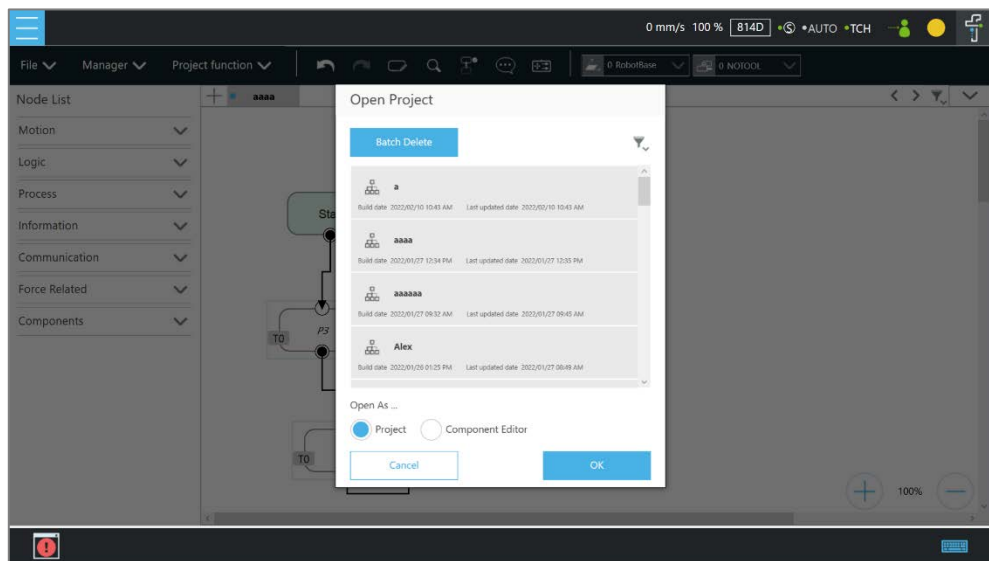

Figure 5 - 11: Open and Delete Project View



**IMPORTANT:**

The currently opened project cannot be deleted and deleted projects cannot be restored.

### 1.26.2 Flow Project

In the **Project Editing Page** of flow projects, users can use TMflow to create projects to design the robot behavior. The node list in the left side is a list of nodes that can be used. Drag the icon of each node to the **Flow Editing Area** to create Flow. Users can click the pencil icon on the node to name the node in the field next to **Node Name** if available. The maximum characters available in the field is 50.

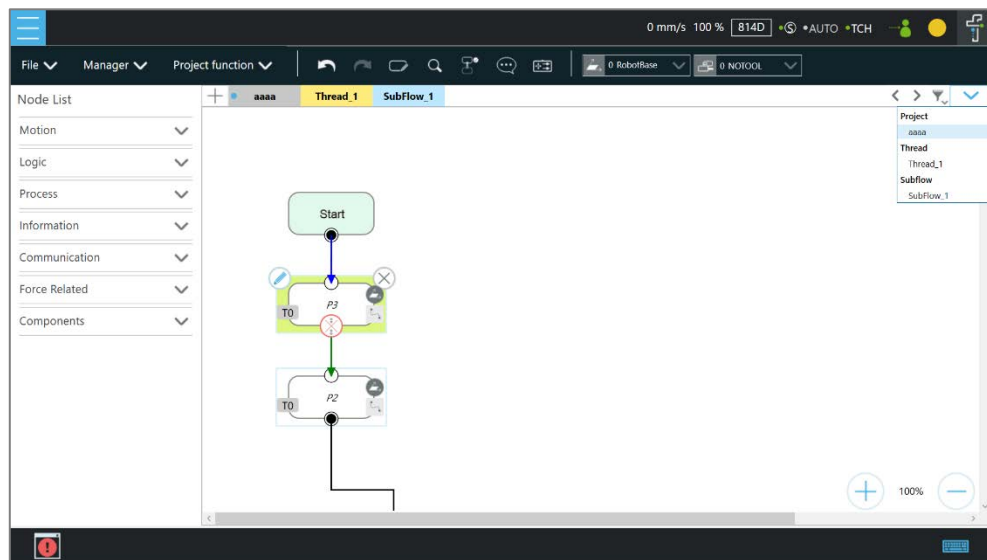





Figure 5 - 12: Project Edit

The green triangle at the top left of the tab denotes in use currently. At the top right of the project editing page, users can click the funnel icon to sort the tabs of the project editing pages in the orders of reverse alphabetical, alphabetical, or chronological, and click  as a dropdown to switch between subflows. At the bottom right of the project editing page, users can click  or  to change display percentage for easier reading.

**Note**

**NOTE:**

- Tabs will be sorted by types with colors in the order of the following.  
Thread (pale yellow) > Subflow (pale blue)
- Identical user-defined names of threads are sorted chronologically.
- If you use a touch screen for project editing, automatic connection mode will greatly simplify your connection process, dragging between each endpoint is no longer needed, simply



enable the automatic connection mode and click on the nodes desired to be connected to connect.

- Hovering the cursor over the button icons will turn the cursor into a hand.

Main	Function	Flow Project
Manager	Point Manager	✓ (1.26.2.1 A Point Manager)
	Base Manager	✓ (1.26.2.1 B Base Manager)
	Variables	✓ (1.26.2.1 C Variable)
	Global Variables	✓ (1.26.2.1 D Global Variable)
	Display Manager	✓ (1.26.2.1 E Display Manager)
Project function	Operation Scene	✓ (1.26.2.2 A Operation Scene)
	Modbus Device	✓ (1.26.2.2 B Modbus Device)
	Set IO while Project Error	✓ (1.26.2.2 C Set IO while Project Error)
	Set IO while Project Stop	✓ (1.26.2.2 D Set IO while Project Stop)
	Stop Watch	✓ (1.26.2.2 E Stop Watch)
	F/T Sensor	✓ (1.26.2.2 F F/T Sensor)
	Camera View	✓ (1.26.2.2 G View)
	Serial Port	✓ (1.26.2.2 H Serial Port)
	Path Generate	✓ (1.26.2.2 I Path Generate)
	Joint Loading	✓ (1.26.2.2 J Joint Loading)
	Network Device	✓ (1.26.2.2 K Network Device)
	Project Lock	✓ (1.26.2.2 L Project Lock)
	Undo	✓ (1.26.2.3 A Undo/Redo)
	Redo	✓ (1.26.2.3 A Undo/Redo)
Edit Block	✓ (1.26.2.3 B EditBlock)	
Search	✓ (1.26.2.3 C Search Function)	
Step Run	✓ (1.26.2.3 D Step Run)	
Comment	✓ (1.26.2.3 E Comment)	
Controller	✓ (1.26.2.3 F Controller)	
Quick Control	✓ (1.26.2.3 G Quick Control)	
Current Base (and Base List)	✓ (1.26.2.3 H Current Base and Base List)	
Current Tool (and Tool List)	✓ (1.26.2.3 I Current TCP and TCP List)	

## 1.26.2.1 Manager

### A. Point Manager

**Point Manager** lists all points and their parameters including the category of points: **General point**, **fine-tuning point**, **dynamic point**, the reference **Base** to which the point is attached, and the tools used by the point. For the creation and applicable nodes of all categories of points, refer to the Point node, F-Point node, and Touch Stop node. In the **Point Manager**,  represents **Vision Base**, and  represents **Custom Base**. Click the pencil icon at the left side of the point to go to the information page of the point where users can modify the

point name and find out the reference coordinates, tools, and detail coordinates of the point: [X, Y, Z, Rx, Ry, Rz]. Users can set the type of motion with either **PTP** or **Line** and its speed at the bottom.

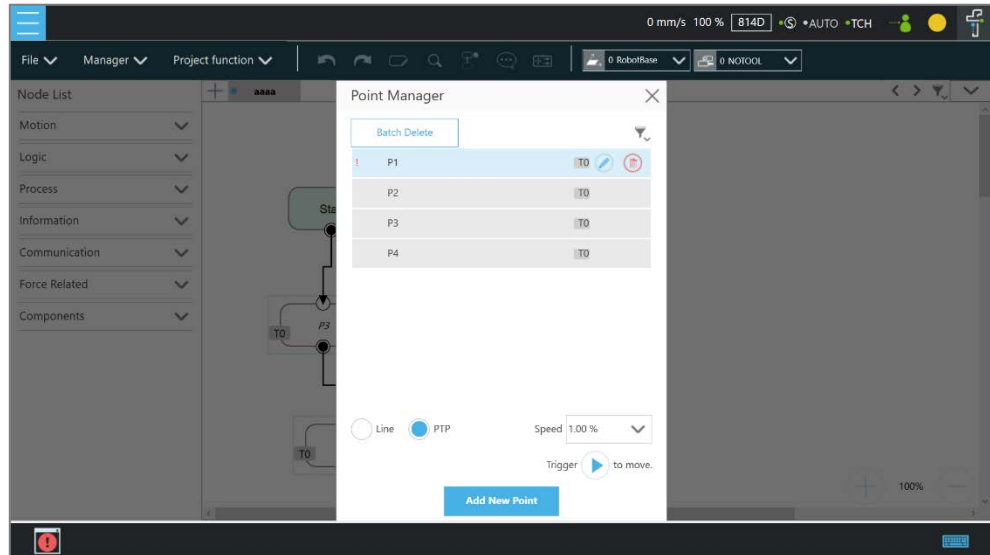

Figure 5 - 13: Point Manager (1/2)

Users can use the dropdown to filter available points in the list and sort the list with the buttons of the point list, reverse alphabetical, alphabetical, or chronological. Click **Batch Delete** to select multiple points to delete. The exclamation mark denotes unused in the flow. For example, if `Point["P1"].Value` functions in the flow, no exclamation mark will present since it regards P1 as used in the flow. However, if written as `Point[var_A].Value` and `var_A = "P1"`, it may regard P1 as not used in the flow.

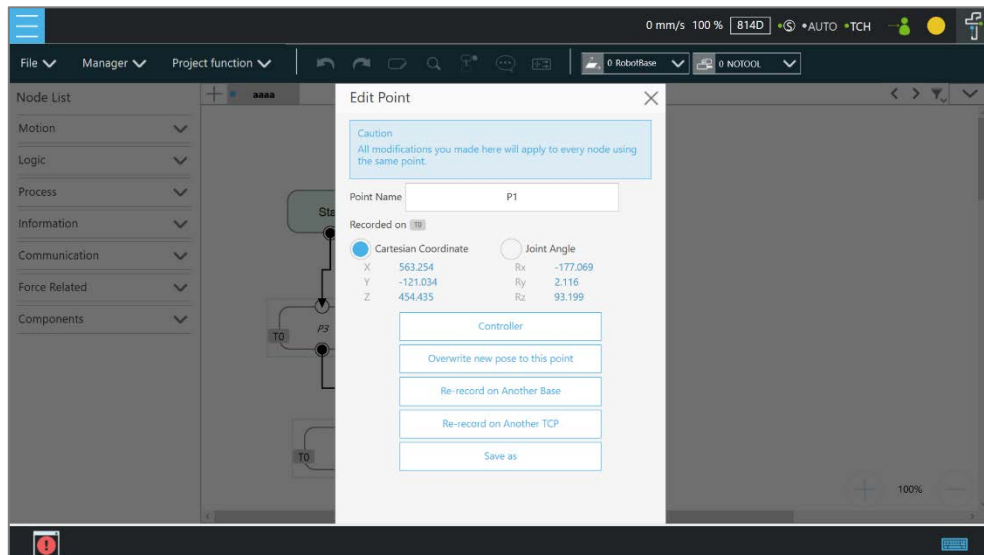

Figure 5 - 14: Point Manager (2/2)



- **Controller:** Enable the Controller to operate robot.
- **Overwrite new pose to this point:** Write the current robot position and posture at this point and overwrite the original value.
- **Re-record on Another Base:** Re-record this point on another **Base**, change the reference coordinate.
- **Re-record on Another TCP:** Re-record another tool for the point when users want to run the same position with a different tool. After selecting TCP, users can select **Keep Pose** to hold the flange position and transfer the TCP position or **Keep Path** to transfer the flange position and hold the point position. Click **OK** when done.
- **Save as:** Save as other point with new name.



**IMPORTANT:**

The point system and the nodes are mutually independent. The changes made in the **Point Manager** will be applied to all the nodes that use this point. Before the change, check all the nodes sharing this point again to avoid the occurrence of unintended motion.

B. Base Manager

**Base Manager** will list all the **Bases** that can be used, the **Current** tag will indicate the **Base** used by the robot at that time,  represents **Vision Base**, and  represents **Custom Base**. Click the pencil icon at the left side of the specific **Base** to access the information page of the **Base**. Clicking **Set as the current base** will change the current reference coordinate used by the robot to this **Base**. Beneath that information, there are tools provided



for users to operate the **Base**. Refer to Chapter 0 Point and Base for the definition of **Base** and 1.33 Create a Custom Base for the details on how to create a **Custom Base**.

Users can use dropdown to filter available base in the list, and sort the list with the buttons of base list, reverse alphabetical, alphabetical, or chronological. Click the **Batch Delete** button to select multiple bases to delete. The exclamation mark denotes unused in the flow. For example, if Base["base1"].Value functions in the flow, no exclamation mark will present since it regards base1 as used in the flow. However, if written as Base[var\_A].Value and var\_A = "base1", it may regard base1 as not used in the flow.

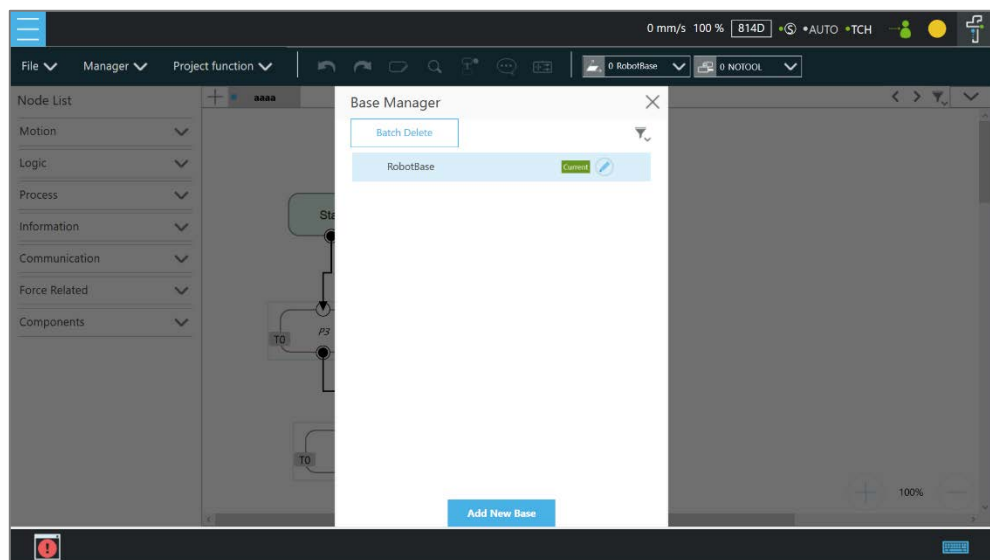

Figure 5 - 15: Base Manager

### C. Variable

The **Variable manager** comes with a list for users to identify status, data types, names, and values of variables or arrays. After choosing the data type and assigning the value and the name, users can click the **Add** button to add new variables or arrays. Click the funnel icon to filter items in the list with the data type. The items in the list are in the order of the dates to create. The newer the date is, the upper in the list it is. Users can change the list order by clicking **Type** or **Name**.

In addition, users can use **Import/Export** to read text files as entities, and users can break them down into pieces or trace them back to the plain code with programming. The text file to read must be less than 2MB in the assigned path. Users can use **Text File Manager** in **Configuration** to check text files in the list. **Variables** created with the type of string can

read data in the text files as values. **Array**, **Global Variables**, and **Variables** created with other types are not supported.



**IMPORTANT:**

- Use " " to enclose the string when inputting the string value to avoid being treated as a variable.
- Do not use reserved words such as var in naming.

D. Global Variable

Using global variables is similar to the variable system in the project, and global variables in this system apply to all projects in addition. Refer to 10.2.2 Global Variables for details.

E. Display Manager

In **Display Manager**, users can set the variables to be displayed on the display panel and interact with users when the project is running. Variables are divided into two types: displayed to users and input by users. The page where users may input variable value can be protected with a password, to avoid unauthorized operators intervening with or modifying the robot's motion behaviors by modifying the variables. On the top part of the display management panel, the time period of the refreshing of the display of variables can be selected from 300, 500, or 1000 in ms. The variable will update the display information according to the set time. Set the refresh time appropriately to avoid users receiving wrong variable information.

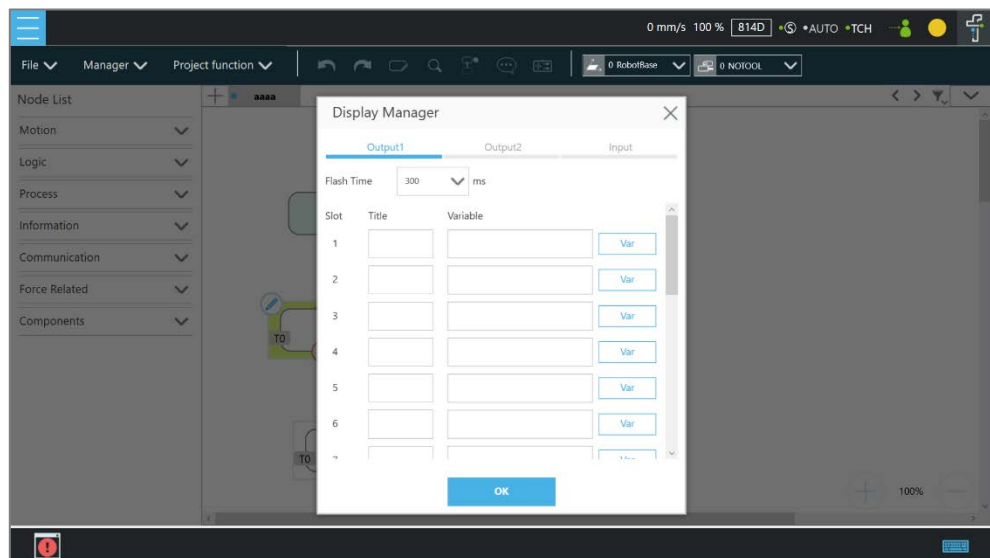

Figure 5 - 16: Display Manager

### 1.26.2.2 Project Function

#### A. Operation Scene

**Operation Scene** can be used to set the operation scene configuration of the project. Refer to Chapter 0 Operation Scene for instructions.

#### B. Modbus Device

**Modbus Device** can be used to set the Modbus master/client in the project. Refer to 1.47 Modbus for instructions.

#### C. Set IO while Project Error

This tool can set the IO output status when the project has an error. Refer to 1.49 IO for instructions.

#### D. Set IO while Project Stop

This tool can set the IO output status when the project stops. Refer to 1.49 IO for instructions.

#### E. Stop Watch

Through **Stop Watch**, users can calculate the running time elapsed between two nodes, plan the motion, manage the production cycles more conveniently through the **Stop Watch** runtime analysis tool, and optimize time for each flow. After clicking **Stop Watch**, click **New** to add a stop watch. **Stop Watch** includes four parts, the beginning node, the ending node, records in a specific variable, and the note description. Check the bullet before **Start** or **End**. Then, click the note to be configured to complete the configuration. To save the variable, when **Stop Watch** is running, the time result obtained while running can be output as the variable to help users analyze this parameter. Select a double type variable in the variable list and fill in the variable box to use this function.

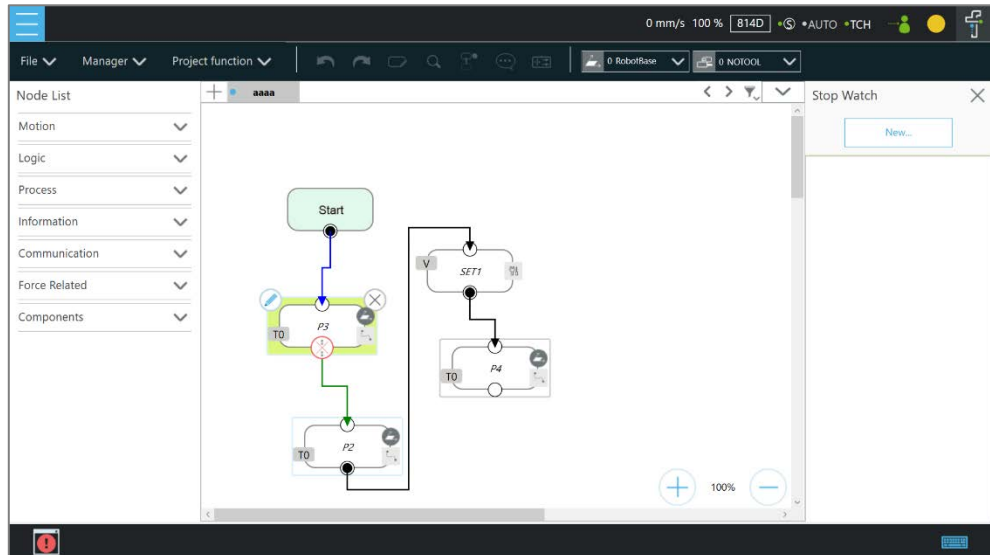

Figure 5 - 17: Stop Watch Setting Page

#### F. F/T Sensor

Refer to 1.54 F/T Sensor for instructions.

#### G. View

**View** provides users with a quick view of the current camera's live image. The camera name can be selected in the upper left corner of the image. Click  below the image to bring up the camera adjustment parameters.



Figure 5 - 18: View Tool Floating Window

#### H. Serial Port

Users can add devices with serial communication interfaces in **Serial Port**. Simply click the icon of **Serial Port** to manage the serial port devices.

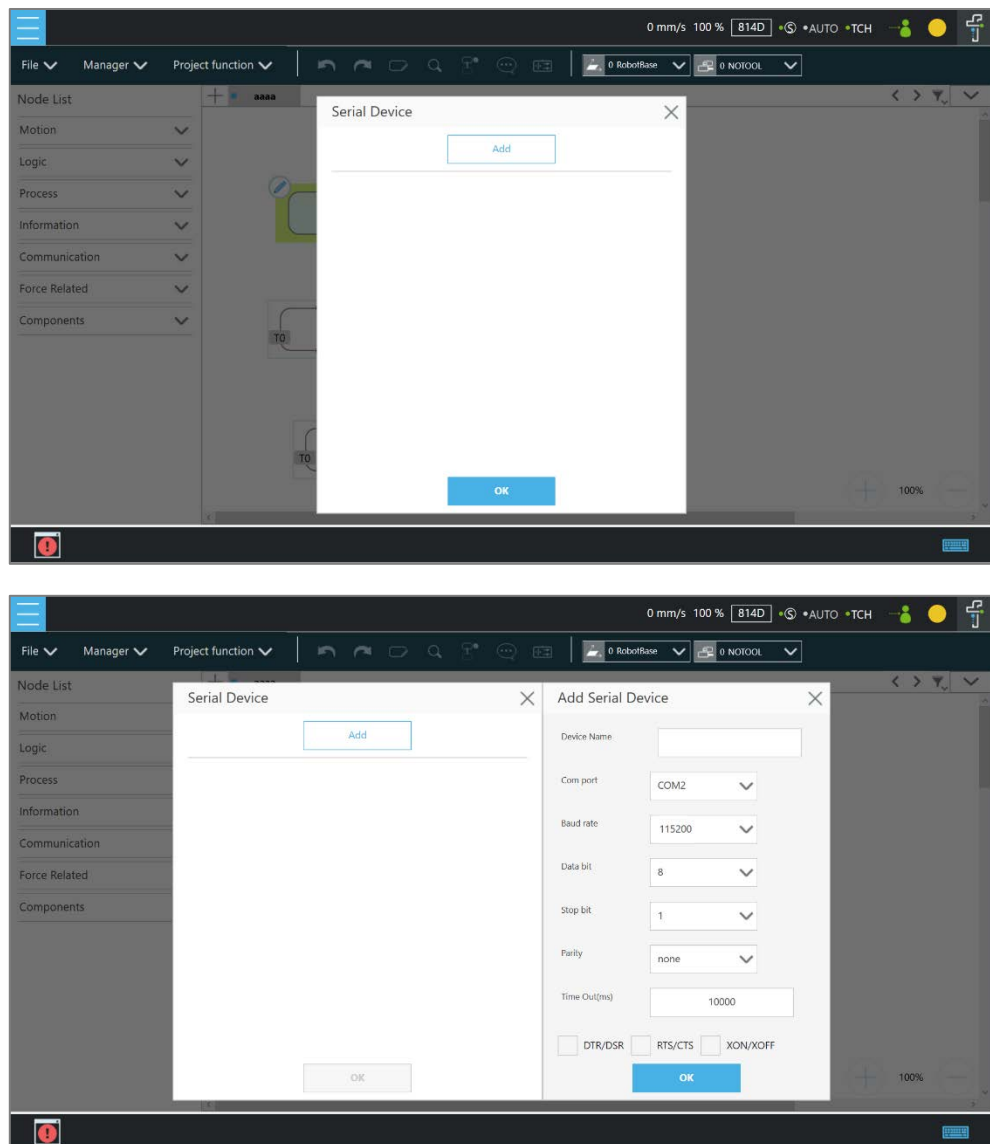



Figure 5 - 19: Serial Port

- To add a device, click **Add**, enter values for **Device Name**, **Com port**, **Baud rate**, **Data bit**, **Stop bit**, **Parity**, **Time Out** in the respective fields as well as check the flow control options, and then click **OK**.
- To edit a device, click on the name of the device, and click on the pencil icon to edit. Every field but **Device Name** is editable.
- To delete a device, click on the name of the device, and click .

Note

**NOTE:**

- The **Modbus** tab in Expression Editor is replaced by the **Connection** tab, and Modbus is in the **Protocol** dropdown.
- The **Baud rate** dropdown offers choices of: 300, 1200, 2400, 4800, 9600, 14400, 19200, 38400, 57600, 115200.  
Users can also input a custom baud rate in the dropdown.

## I. Path Generate

In **Path Generate**, users can generate complex curves by hand guiding with the F/T sensor. Simply click the icon of **Path Generate** to use the function.



Create a new motion record.



Open a motion record or a path file.



Save as a path file applicable to the path node.

- Choose the base and the tool in the dropdowns at top left. Click the record icon to start recording the path. Hand guide the robot moving while recording is in progress. Click the stop icon to stop recording.
- Click the **Time** button to set **Time Sampling** parameters. Click the **Position** button to set **Position Sampling** parameters. Points on the path in the 3D viewer vary from **Time Sampling** and **Position Sampling**.
- Click the **Run** button for the trial run with the recorded path. Users can set **Direction**, **Data Type**, or **Speed**. Click the Move (+) button or the + button of the robot stick to move the robot along the recorded path. Hold the button for continuous moving. Click the **Reset** button to set **Direction**, **Data Type**, or **Speed** again.

Note

**NOTE:**

The motion record is generated after recording the path with the lowest possible sample rate and the distance log. The motion record is not applicable to the path node. Save the motion record as a path file to use in the path node.

**IMPORTANT**

**IMPORTANT:**

Make sure the robot stays still, and no extra force applies to the external force sensor, such as touching the tool or the external force sensor by hand, before releasing the FreeBot button. If releasing the FreeBot button while the robot is moving, the robot might vibrate or hop for the brake, which may result in errors on joints in the extreme conditions.

## J. Joint Loading

**Joint Loading** can monitor the loading that every node brings to the robot joints and keep repeating peak torque away. Simply click the icon of **Joint Loading** to use the function.

Follow the steps below to use **Joint Loading**:

1. Click the switch next to **Display Indicator** to turn on or off the rectangle encloses each node in the project.
2. Check or uncheck the desired levels of the risk indication on each node.
3. Click the **Apply** button to have the setting take effect.

Once **Display Indicator** turned on and all levels of the risk checked, the rectangle encloses each node in yellow for **High Risk**, blue for **Low Risk**, and gray for **Unknown**. To turn off the rectangle encloses each node, switch off **Display Indicator** in **Joint Loading**.

Gray (unknown) denotes the system did not execute this part of motion during the last operation, and thus the system cannot figure the output of each joint during the actual process. Yellow (high risk) denotes the output at some joints is higher than the allowable repetitive peak torque. The condition of the output, in the long run, will considerably affect the service life of the joint. Users can increase the joint acceleration time or decrease the joint motion speed to reduce the joint unit loading.

Below the **Apply** button, every node in the project will be listed with the type and the name. **Joint Loading** on every node takes effect after the project execution. The high risk node will come with the reference speed reduction ration in the list. Users can click the reverse alphabetic, alphabetic, or chronologic buttons to sort the listed nodes.

#### K. Network Device

Users can add new network devices in **Network Device**. Click the **Network Device** icon to go through the setting. Users can input an integer larger than 0 in field next to **Time Out** to customize the time out value.

- To add a network device, click **Add Device**. Fill the device name, the IP address, and the port in the respective fields, and click **OK**.
- To edit a network device, select the device in the list and click the pencil icon. Edit the data in the field to edit, and click **OK**.
- To delete a network device, select the device in the list, and click .

## L. Project Lock



To protect the project from being modified unwillingly, users can use project lock to deny or grant access to **Manager** and **Project Function**.

Users can even assign which nodes are editable with Project Lock. To do that, check the box **Node Editing** and click the nodes going to be editable in the project. These nodes would be in the list of **Editable Nodes**. Users can click the item in the list so that the project focus would directly jump to that node. There are also three function buttons above the list: lock all, unlock all, and sort. After having the setting done, click the enable switch above and click **Apply** at the bottom.

Note that this function applies to the accounts with the Project Lock permission only. To learn more about project lock permission, refer to 1.28.3 User & Permission.

### 1.26.2.3 Others

#### A. Undo/Redo

While editing the project, users can click  to redo or click  to undo changes of adding normal nodes, duplicating normal nodes, or deleting normal nodes up to 20 steps.

#### Note

#### NOTE:

The 20 steps of redo or undo changes do not apply to adding, duplicating, and deleting of the **Component**, the **Subflow**, and the **Thread** as well as normal nodes that disappear due to the operations of the **Component**, the **Subflow**, and the **Thread**.

#### B. EditBlock

By extending the **EditBlock** menu, multiple nodes can be selected, either by dragging the mouse, while pressing the left mouse button, to draw a frame around the desired icons, or by simply clicking each desired icon. Clicking a selected icon deselects it. Users can drag and drop all the selections, click the **Copy** and **Paste** icon to copy and paste all selected nodes, or perform **Base Shift** or **Speed Adjust** for all nodes. Moreover, users can set **Payload** with a value or a variable in integer, float, or double, check the options in **Blending** to reduce the number of robotic brakes and the cycle time, and **Precise Positioning** to set how nodes locate in particular. All **EditBlock** related behaviors, including copy-and-paste function, can only be performed under the same project.



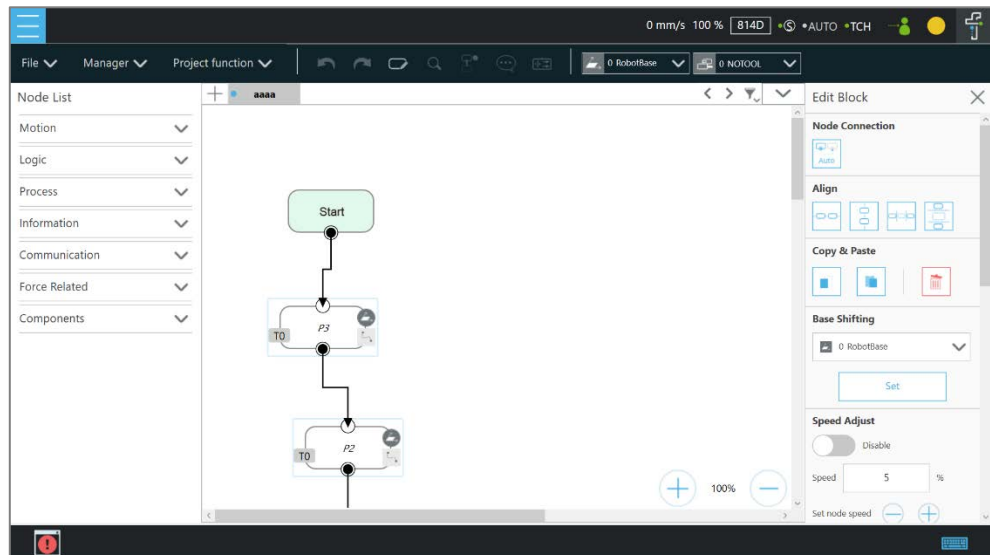



Figure 5 - 20: EditBlock (1/2)

Click  to enable automatic connection mode. Click any two nodes in the automatic connection mode to connect both of the nodes based on the clicking order, and click the **Cancel** button to exit the automatic connection mode upon completion of programming.

Users can click  at the top right, select nodes, and click the icon of the desired arrangement at the top right to align nodes in the page as shown below. The first selected node acts as the alignment node for the other nodes. If the first node is deselected, the second selected node becomes the alignment node.

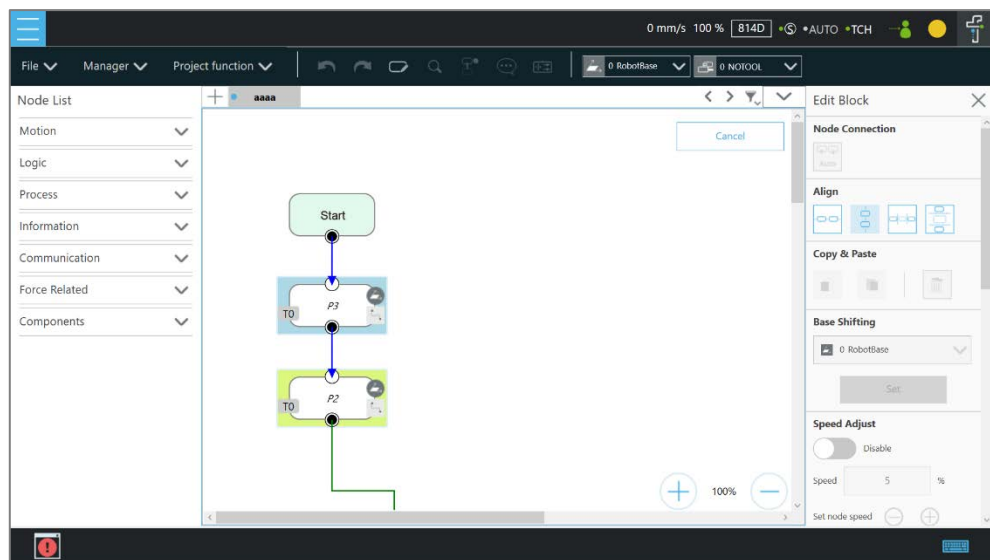
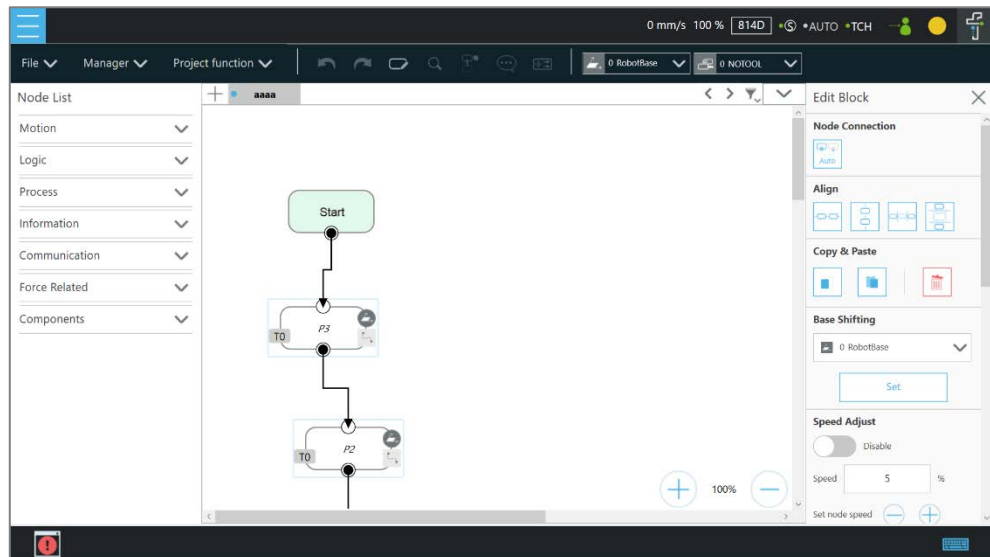

Figure 5 - 21: EditBlock (2/2)

### C. Search Function

In Search Function, the search can be performed by the node name or variable name. Input the keyword to look for in the search bar. Click the **X** icon to erase the keyword. Select **Node** or **Var** in the first dropdown to search for nodes or variables, respectively. Users can narrow the search range with the dropdowns next below for a specific tab or a specific category of nodes. To jump to a specific search result, click the item in the result list directly. Users can enter an asterisk in the node name to search for all similar nodes in the flow. If an exclamation mark is displayed in the search result, it denotes that the node has not been set, and users must enter the node to complete the required settings.

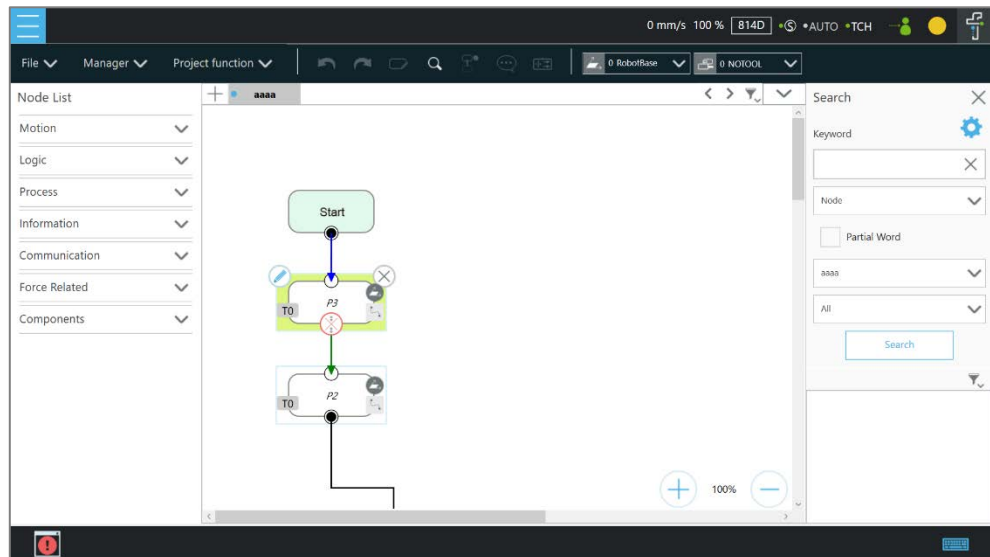

Figure 5 - 22: Searching Pane

#### D. Step Run

**Step Run** is used to confirm accuracy of the edited motion. The first node of a Step Run can be a Start, a Point Node, or any node that is not grayed out. This allows users to easily evaluate the correctness of the node/motion. **Step Run** can start running from the selected node to have the robot moving by pressing and holding the Enabling Switch and the **Play** button on the **Robot Stick**. At any time, releasing the Enabling Switch and or the **Play** button on the **Robot Stick** will stop the robot movement, and pressing and holding the Enabling Switch and or the **Play** button on the **Robot Stick** again will start the robot moving from where it stopped. When the **Step Run** pane displays **(Node name)\_finish**, the node running is completed. Release the Enabling Switch and the **Play** button on the **Robot Stick** and press and hold again to continue to the next node. If the **Step Run** window is open, the **FREE** button at the **End Module** cannot be used to hand guide the robot. Also, both the variable system and the decision formula will not operate. When there is a logical branch node (e.g., If Node, Gateway Node) the path of pass or fail can be selected freely to check that each decision branch's internal motion programming is correct using **Step Run**.

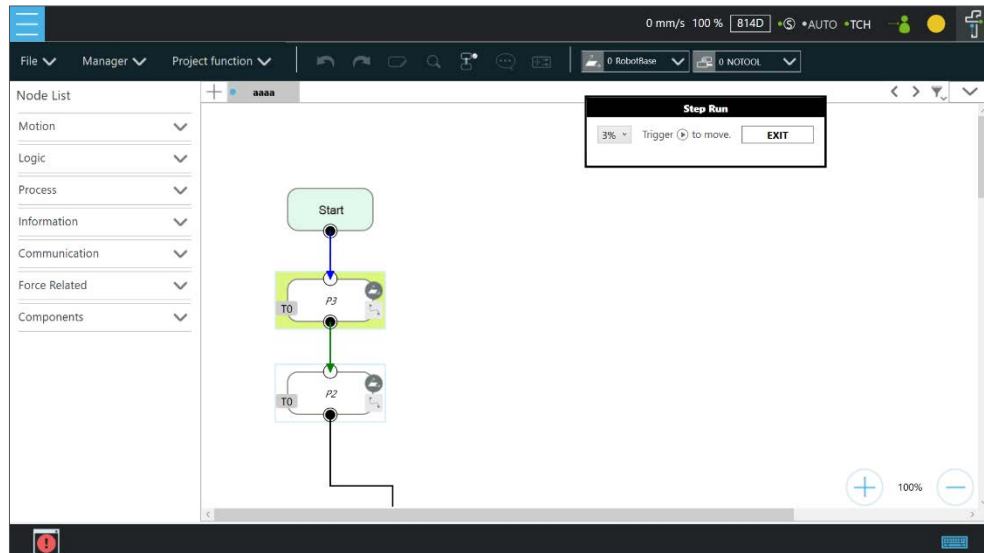



Figure 5 - 23: Step Run



**IMPORTANT:**

When using **Step Run** through a **Subflow** node, click **RUN** to enter the **Subflow** page, or click another node to skip the **Subflow** steps. Although the variable system will not operate, the **Vision** node will run. Users can refresh the **Vision** node parameter value and output value through a **Step Run Vision** node to facilitate subsequent programming and tweak. Since the variable system will not work, the **Pallet** node will only run for the first point.

E. Comment

Comment Note provides users for commenting and taking notes in the project to increase the readability of the project. Click the  icon in the toolbar to launch the comment interface at the right side of the project editing page as below. After launching the Comment Note interface, the node list is not editable. If users want to continue editing the project, please click the  icon at the top right of the interface.



**NOTE:**

A project can add up to 100 comments, and each can be up to 500 characters.

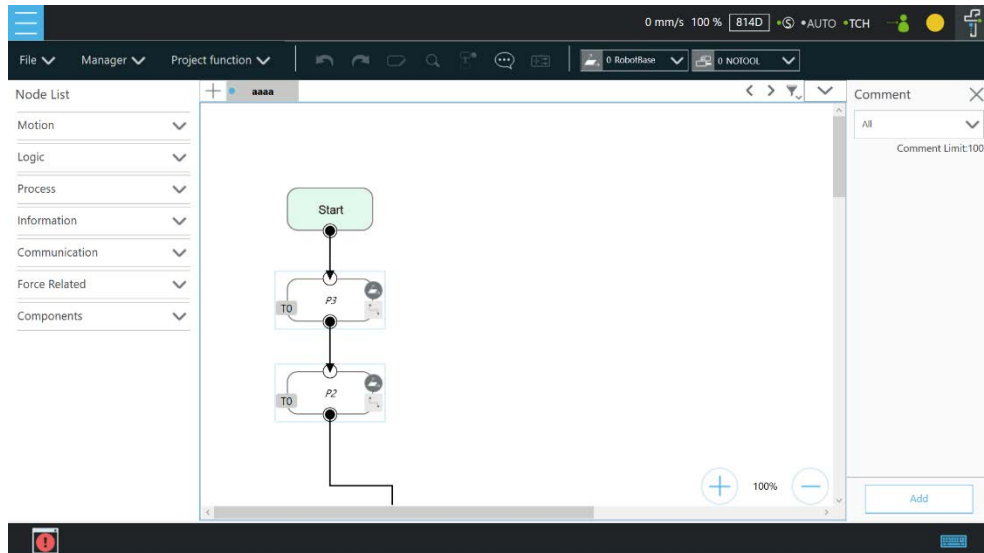





Figure 5 - 24: Comment

To start adding a comment, click the **Add** button below. Users can add a comment after selecting some nodes to comment or users can just add without linking to any nodes. After adding a comment, there will be a comment note icon, , added to the project with the linked nodes highlighted. Also, it enters directly its editing mode as soon as the comment note is created. In the edit mode, users can write text in the text box. Click , , or  to cancel, delete, or confirm the text in the text box, respectively. Users can add or delete linked nodes by clicking nodes.

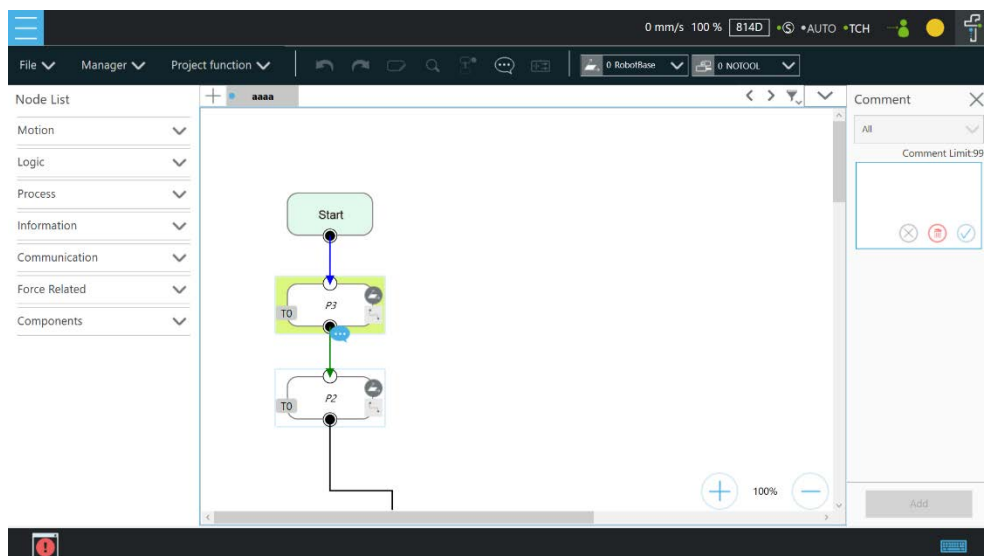



Figure 5 - 25: The Comment Note Editing Mode

At the top of the interface, there is a filter to display comment notes from all or a specific flow

page. Whenever users click comment note in the list inside of interface or the icon  in the flow page, the system highlights the comment note includes linked nodes. In addition, the flow editing page will jump to the respective page if users click a comment note in the other flow pages.

## F. Controller

**Controller**  provides users with direct control of the robot on motion control, **IO** control, and **Settings** for **Freebot**, **Jog**, and **Joystick**. Motion control includes three tabs: **Joint**, **Base**, and **Tool**, which correspond respectively to moving according to the joint angle setting, moving according to the robot **Base** or the current **Base**, and moving according to the **Tool Coordinate**.

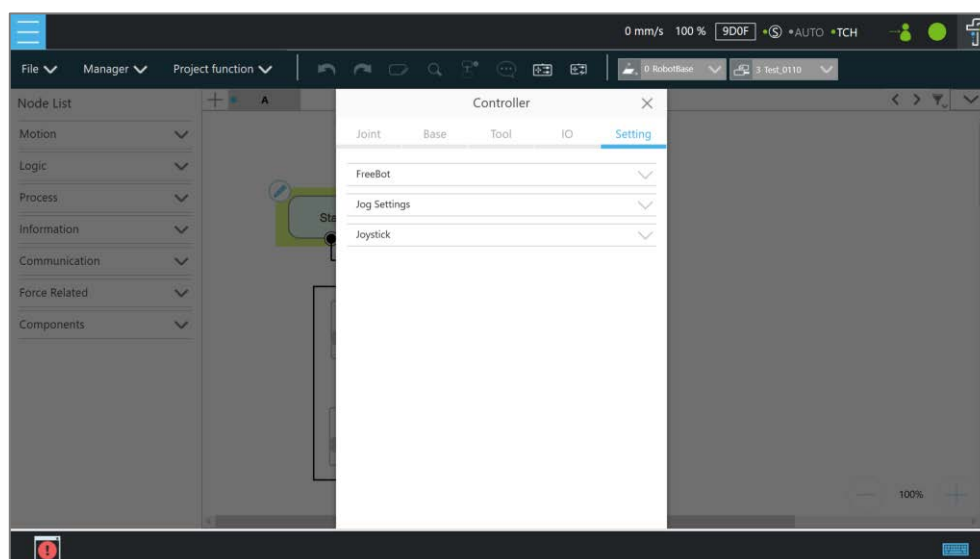

Figure 5 - 26: Controller

- **Motion Control:** In the tab of **Joint**, **Base**, or **Tool** tabs, there are two motion control methods:
  - **Single-joint/single-axis movement**  
 To use single joint/single-axis movement, click the joint/axis to move first, and then hold the Enabling Switch on Robot Stick and press the **+** button or **-** button on the Robot Stick to move the joint/axis in the positive or the opposite direction. Press the **STOP** button to switch the selected joint/axis to the next option.
  - **Moving to a specific target**  
 To move a specific target, enter the target in the textbox at right, hold the Enabling Switch on Robot Stick, and press the **PLAY** button on the Robot Stick to move the

robot to the target position.

Note

**NOTE:**

- The selections in the dropdowns, the solid circles, and the input values in the fields will remain even after switching the tabs until users exit the **Controller**.
- **Controller** comes with the protection mechanism to prevent the joint to report the hardware error with the oversized interpolations from sending the position command with a large gap.

IMPORTANT

**IMPORTANT:**

The **Base** tab is used to move to a specified target with respect to the specified **Base**, and the **Tool** tab is used to move in a specified direction with respect to the **Tool Coordinate**.

- **IO Control:** Click **IO** tab to open the **IO control page**. In the **IO control**, the output value of each IO can be controlled independently, including **Control Box IO**, **End Module IO**, and **Camera Module IO**. For detailed IO specifications and applications, refer to Chapter 1.49 IO.

Note

**NOTE:**

**Safety Connector** IO is read-only and users cannot change the state in TMflow.

- **Setting:** This tab provides users with changing the behavior and the control settings.
- **FreeBot:** In FreeBot, Robot Joints is set as default control mode. The movement limits of the robot while pressing the FREE Button can be set.
  - In **FreeBot**, **Robot Joints** is the control mode by default. Users can set the robot movement limits while pressing the **FREE** button. The settings go with **Free all joints**, **Free XYZ**, **Free RXYZ**, **SCARA like**, and **Custom Setting**. When the control mode is **Robot Joints**, check **Clear Payload** and press the **FREE** button to clear payload for obtaining the correct TCP force and joint torque.

Users can set the control mode to **F/T Sensor** for hand guiding in the current project and select F/T Sensor in the dropdown if installed an F/T sensor to the robot. If users exit the project, hand guiding with the F/T sensor becomes unavailable until users set the control mode to **F/T Sensor** in **Controller** again.

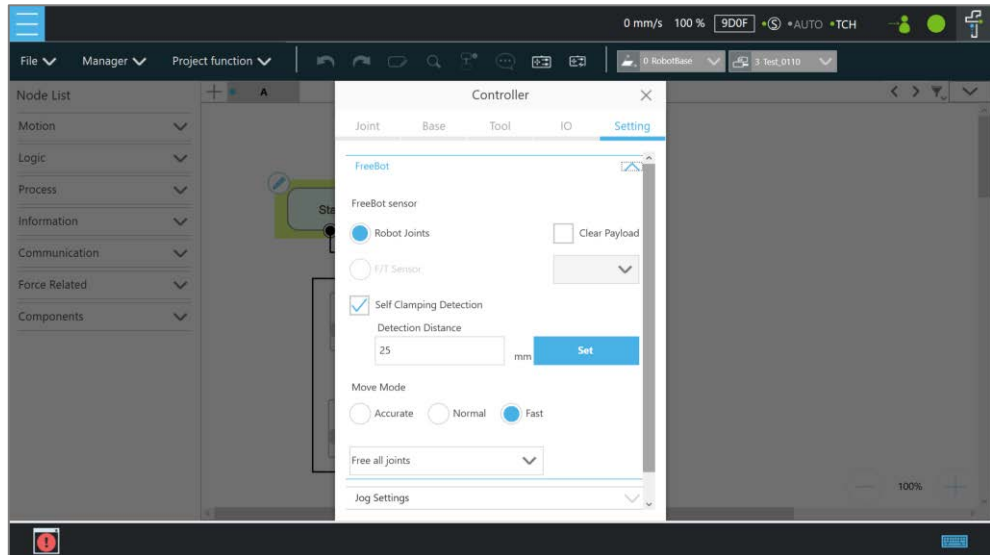

Figure 5 - 27: Controller (FreeBot Control)

- ◆ **Free all joints:** Freely drag the robot while pressing the **FREE button**.
- ◆ **Free XYZ:** Use the **FREE button** to make the robot performing translation-only motion in **Robot Base**.
- ◆ **Free RXYZ:** Use the **FREE button** to make the robot performing rotation-only motion in **Robot Base**.
- ◆ **SCARA like:** Use the **FREE button** to make the robot performing motion on X, Y, Z, RZ directions of **Robot Base** as the traditional SCARA robots. This mode is suitable for teaching simple pick and place jobs to avoid accidentally causing unnecessary rotation in Degrees of Freedom when teaching.
- ◆ **Custom Setting:** Freely set the degree of freedom to be released and fixed, to facilitate hand guiding. Once set the selection, it prompts an error message window if there is no box checked in Base Coordinate or Tool Coordinate.

Button	Function
Free all joints	Six Degrees of Freedom. The robot movement and posture change are not restricted.
Free XYZ	Three Degrees of Freedom. The robot end can move in XYZ directions only.
Free RXYZ	Three Degrees of Freedom. The robot end can change its orientation only.
SCARA like	Four Degrees of Freedom (X, Y, Z, RZ)
Custom Setting	Degrees of Freedom to be set by users

Table 5: FreeBot Degree of Freedom Limitation

- ◆ **Self-Clamping Detection<sup>1</sup>:** When the FreeBot is in use, it may hurt users potentially because the robot link and the installed tools may clamp around users' hands and fingers. So, users can enable this function to reduce



clamping risk. (This function is set between 25 to 30 mm as an integer.)



**NOTE:**

1. The robot takes the CAD models in its workspace, including CAD imported via the Operation Scene function, into account only.
2. This function does not apply to HW 3.2.

◆ **Move Mode** is for users to adjust the initial damping of joints with modes of **Accurate**, **Normal**, and **Fast**. Damping increases the hand guide weight allowing faster stoppage while releasing the **FREE** button. For easier dragging, joint damping decreases proportionally as TCP speed increases during the hand guide. Once damping drops to zero, it stays at zero until the **FREE** button is released.

- **Accurate:** The highest joint damping. For the high initial force requirement with fast stoppage while releasing the FREE button.
- **Normal:** The low joint damping. For the medium initial force requirement with reasonable accuracy while stopping.
- **Fast:** The zero joint damping. For the low initial force requirement for dragging.



**IMPORTANT:**

The **FreeBot** setting is still valid after the controller page is closed. Therefore, if users find that the robot cannot be moved in certain degree of freedom, check whether the **FreeBot** setting is correct.

■ **Jog Settings**

Users can check **Light** or **Buzzer** indicators for Cyclic Selection in the Joint, Base, and Tool tabs when users press the STOP button on the robot stick to switch moving joints or axes. The indication pattern is as follows:

Joint/Axis Selected	Light Indicator	Buzzer Indicator
J1/J4/X/RX	Short Flash	Short Buzz
J2/J5/Y/RY	Short Flash * 2	Short Buzz * 2
J3/J6/Z/RZ	Long Flash	Long Buzz

■ **Joystick**

Joystick control is a convenient function for users to control the robot when they are focusing on teaching or inconvenient to use FreeBot on an extended-length

robot. In addition to motion control, joystick control provides the functions of point recording and gripper control for users' convenience to program. This function allows users to control the robot through Joystick in manual mode only.

Before using it, users should be aware of the limitation and definitions below.

1. To comply with the single point of control in the safety regulations, only one device, either Robot Stick or Joystick, is available at a time.
2. Joystick supports the XInput type devices only.
3. If multiple joysticks are connected, only the first recognized is available.
4. Joystick control is only available in Project and certain pages with controller functions.



Icon	Description
None	At the invalid page or no joystick connected.
	At the valid page and the joystick connected without control access.
	At the valid page and the joystick connected with control access.

Table 6: Joystick Icon Descriptions



**NOTE:**

Refer below for the tested devices available for Joystick control:

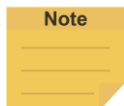
<ul style="list-style-type: none"> <li>● Logitech Wireless Gamepad F710</li> </ul>	 <p>*Set the switch to Xinput mode as shown.</p>
<ul style="list-style-type: none"> <li>● Xbox Wireless Controller (Model 1708)</li> </ul>	

Joystick control has defined various motion modes on the button operations by the single keys or combinations. Thus, the software interface is for the control access and the current operating status display. The description is as below:

- ◆ **Joystick Control Access:** Switching off denotes granting the control access to the robot stick but not the joystick, and on, the control access to the joystick but not the robot stick.

- ◆ **Control Type:** The reference type of the current movement by **Joint**, **Base**, or **Tool**.
- ◆ **Jog Distance:** If in step mode, it displays the current moving distance by the current control type:
  - **Joint:** 0.01°/ 0.05°/ 0.5°
  - **Base/Tool:** 0.05 mm/ 0.5 mm/ 5 mm
 If in continuous mode, it displays **Continue**.
- ◆ **Speed:** The current movement speed by the current control type:
  - **Joint:** 0.5%/ 1%/ 3%
  - **Base/Tool:** 1%/ 5%/ 10%

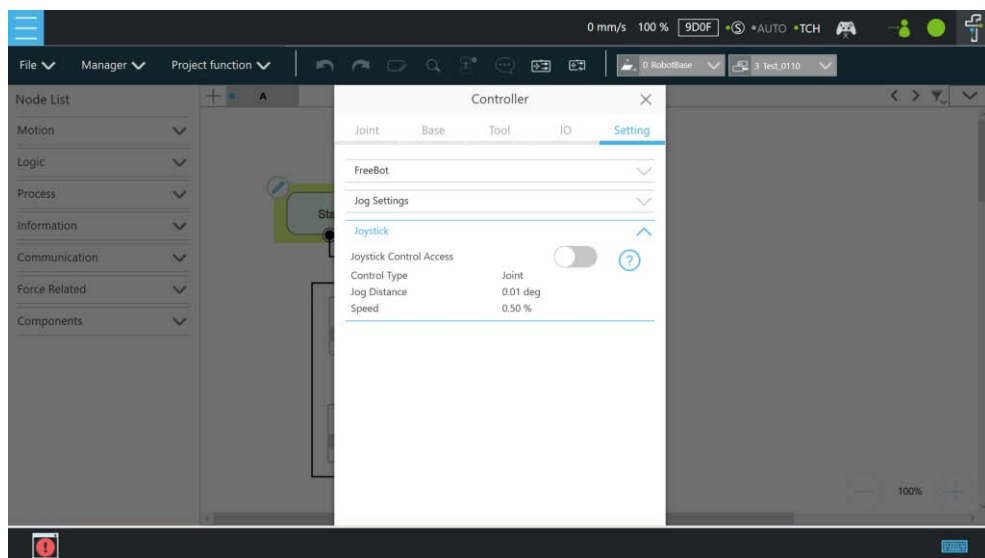

Figure 5 - 28: Joystick Control

Designed by the XInput type, **Joystick Control** applies to any joystick that supports XInput. If using a joystick with a different brand, please refer to its manual. Below defines the button functions with an Xbox Controller depiction.

Button	Function
Start	Joystick Get Control Access, Robot Stick Disable
Back	Joystick Release Control Access, Robot Stick Enable
Left Stick / D-pad	↑ Y+/ RY+/ J2+/ J5+, by the control type and RB.
	↓ Y-/ RY-/ J2-/ J5, by the control type and RB.
	← X/ RX-/ J1-/ J4-, by the control type and RB.
	→ X+/ RX+/ J1+/ J4+, by the control type and RB.
Right	↑ Z+/ RZ+/ J3+/ J6+, by the control type and RB.

Stick	↓	Z-/ RZ-/ J3-/ J6-, by the control type and RB.
LB		Release : Step Press : Continue
RB		Joint: Release : J1, J2, J3 Press : J4, J5, J6 Base / Tool: Release : Linear Press : Rotation
LT		Speed Switch: three-speed switching Joint: 0.5%, 1%, 3%. Base / Tool: 1%, 5%, 10%.
RT		Jog Distance Switch: three-distance switching Joint: 0.01°, 0.05°, 0.5°. Base / Tool: 0.05 mm, 0.5 mm, 5 mm
X		New Point
Y		Gripper Set
B		Control Type Switch: Joint / Base / Tool

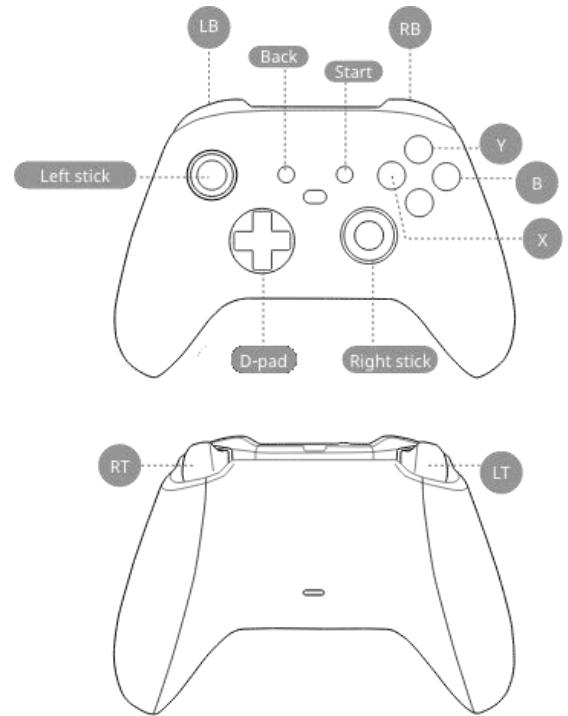
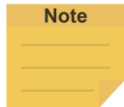

Table 7: Joystick Button Definitions



**NOTE:**

The start and the back buttons function the same as getting and releasing the joystick control Access in the UI.



**IMPORTANT:**

- Only single-axis motion is supported.
- While in motion, other functions like displacement speed switching, displacement switching, control type switching, etc., are invalid.
- Axis is not switchable while in motion.
- While in motion, the state of the triggered button must maintain.

For joysticks with the vibration function, once switch is triggered, they will get vibration feedbacks with definitions as below.

	Control Type switch	Jog Distance switch	Speed switch
short vibration	Joint	Small Distance	Low Speed
continuous short vibration	Base	Mid Distance	Mid Speed
long vibration	Tool	Large	High Speed

G. Quick Control

The **Quick Control**  is a floating window with a simplified motion control interface.

Users can access the flow editing area with Quick Control opened, allowing simultaneous jogging and project editing and removing the need to repeatedly open and close the controller page. It brings convenience when users have trouble access to screens, mice, or keyboards.

The **Quick Control** comes with the control type button, DoF buttons (linear/rotation), and Freebot Lock buttons (linear/rotation) at the top.











Control Type	Click to switch between modes of  Joint,  Base, and  Tool.	
	DoF	When in base mode or tool mode, click  as the linear DoF button to set single axis movement to linear mode or click  as the rotation DoF button to set single axis movement to rotation mode.
	Control Axis	When in joint mode, users can press the STOP Button on the Robot Stick to jump from one axis to another. The interface will highlight the selected axis. In Linear mode, axis options are XYZ axes (J1/J2/J3); in Rotation mode, axis options are RXYZ axes (J4/J5/J6).
Freebot Lock	Click  as the linear or  the rotation Freebot buttons to toggle on/off lock of the linear and the rotational movement for FreeBot hand guiding. Button combination associated to the Freebot settings are: <ul style="list-style-type: none"> <li>●  for Free All joints</li> <li>●  for Free XYZ</li> <li>●  for Free RXYZ</li> </ul>	
Motion Control	Click the + or the – button to move the robot along the axis in the positive or the opposite direction.	
Show\Hide Option	Click to show or hide options including <b>Jog Distance, Speed, Enable Axis Display, Display Distance, and Rotation.</b>	
Enable Axis Display:	This function acts as a display of direction for motion control. Once checked, users can hold the STOP Button on the Robot Stick for one second to trigger the axis display. Aside from switching the control axis, the robot will move along the new axis in the positive direction for a selected distance and move in the opposite direction for the same range to display.	

Table 8: Quick Control



**IMPORTANT:**

Once the STOP Button is released, the robot movement stops immediately. Holding the STOP button until the axis display motion completes is advised.

H. Current Base and Base List

**Base list** will list all Bases for this project and also indicates the **Current Base**. In the base list, the front symbol represents the type of **Base**, and represents **Vision Base**, represents **Custom Base**. The **Base** displayed in the box is the **Current Base** and can be replaced through clicking the list.

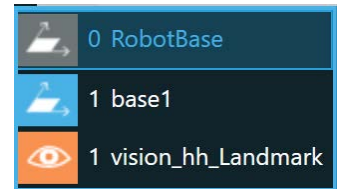

Figure 5 - 29: Base List



**IMPORTANT:**

1. When users click on the **Base List** and add a new point, the point will be recorded on the **Current Base**.
2. In script projects, users should use TBase class to set Custom or Vision Bases in the defined function. (Refer to *Programming Language TMsScript* for syntax.) Once users press **Compiler** or **Save**, the Base list will register the declared Bases.

I. Current TCP and TCP List

**TCP list** will list all the TCPs. In the TCP list, the front symbol represents the type of tool, represents the general TCP, and represents the built-in TCP list of the hand-eye camera. The TCP displayed in the box is the current TCP, and can be replaced by clicking on the list.

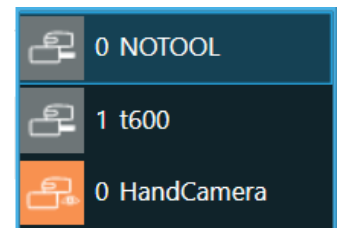

Figure 5 - 30: Tool List



**IMPORTANT:**

1. When users click the TCP list and add a new point, the point will be recorded with the current TCP.
2. In script projects, users should use TTCP class to set a TCP. (Refer to *Programming Language TMsScript* for syntax.) Once users press **Compiler** or **Save**, the TCP list will figure the declared TCP.

1.26.3 Script Project

Users can program by scripting in the area as below. Refer to *Programming Language*

TMscript for details on the syntax.

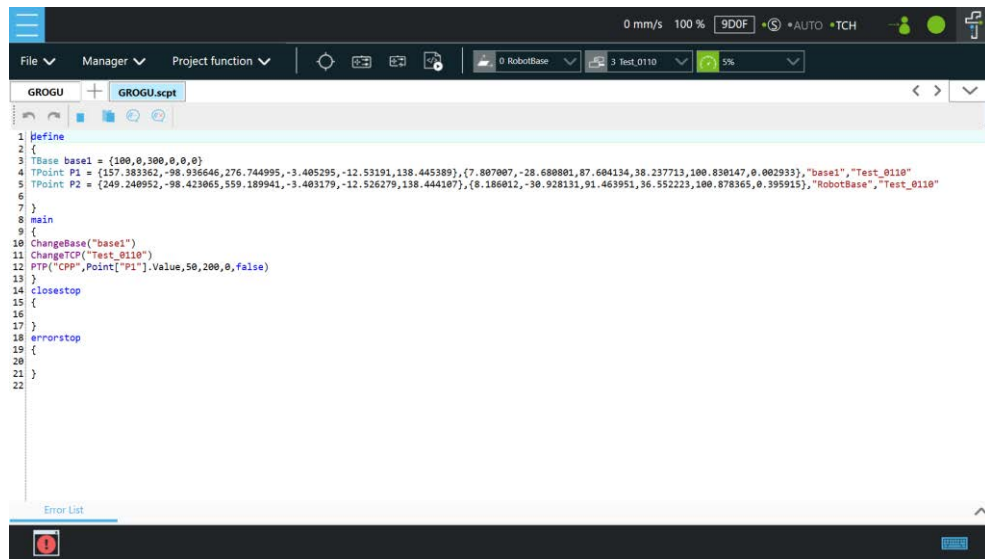

Figure 5 - 31: Script Editing Area











Item	Function
	Undo
	Redo
	Copy: copy selected text.
	Paste: Paste the copied text to the current mouse position.
	Comment: Use the number of selected lines as comments (add // in front), and the annotated code will not be executed.
	Uncomment Uncomment the number of selected lines (remove the front //)
	Search:  : Match case,  : Previous matched result,  : Next matched result,  : Close the Search Bar (Use <b>Ctrl+F</b> to open.)

Table 9: Script Editing Items

Every time users complete script editing, they can use **Syntax Check** at the toolbar to validate functions, syntax, variables, etc. The error list at the bottom prompts automatically after the validation finishes. Users can fix the errors by the messages in the error list.

**Note****NOTE:**

If users run the script project directly without going through **Syntax Check**, the system will validate it automatically when pressing the play button on the stick. If an error exists, it is forced to stop running and will stop at the script editing page.

Main	Function	Script Project
Manager	Global Variables	✓ (1.26.3.1 A Global Variable)
	Vision Manager	✓ (1.26.3.1 B Vision Manager)
Project function	Operation Scene	✓ (1.26.3.2 A Operation Scene)
	Camera View	✓ (1.26.3.2 B View)
	Teach Point	✓ (1.26.3.3 A Teach Point)
	Controller	✓ (1.26.3.3 B Controller)
	Syntax Check	✓ (1.26.3.3 C Syntax Check)
	Quick Control	✓ (1.26.3.3 D Quick Control)
	Current Base (and Base List)	✓ (1.26.3.3 E Current Base and Base List)
	Current Tool (and Tool List)	✓ (1.26.3.3 F Current TCP and TCP List)
	Project Speed	✓ (1.26.3.3 G Project Speed)

### 1.26.3.1 Manager

#### A. Global Variable

Refer to 1.26.2.1 D Global Variable for details.

#### B. Vision Manager

Vision manager helps users manage their vision jobs, and users can use it to create vision jobs. For further details on vision programming, refer to *Software Manual TMvision*. For the generated information such as vision bases and variables, please copy it to the defined function to declare. And then, the user can use the function like `Vision_DoJob_PTP` to execute a specified vision job. (Refer to *Programming Language TMscript* for details on the syntax.)

### 1.26.3.2 Project Function

#### A. Operation Scene

Refer to 1.26.2.2 A Operation Scene for details.

#### B. View

Refer to 1.26.2.2 G View for details.

### 1.26.3.3 Others

#### A. Teach Point



Click  to insert the point information with the tool position coordinate, the joint angles, the current base, and the current tool into the defined function of the script project. This toolbar function applies to script projects only.

B. Controller

Refer to 1.26.2.3 F Controller for details.

C. Syntax Check

Click  to validate the syntax of the script and update the Base list and the TCP list by the content in `define{}` of the script.

D. Quick Control

Refer to 1.26.2.3 G Quick Control for details.

E. Current Base and Base List

Refer to 1.26.2.3 H Current Base and Base List for details.

F. Current TCP and TCP List

Refer to 1.26.2.3 I Current TCP and TCP List for details.

G. Project Speed

Users can set the project speed when the robot is running.

## 1.27 Configuration

The parameters related to the robot can be set in **Configuration**. The parameters, from left to right and from top to bottom are: **Wizard, Vision Settings, Tool Settings, IO Setup, Safety, Controller, Speech, End Button, Component, Connection, Posture Settings, Service Engine Settings, Text File Manager, Motion Settings**.

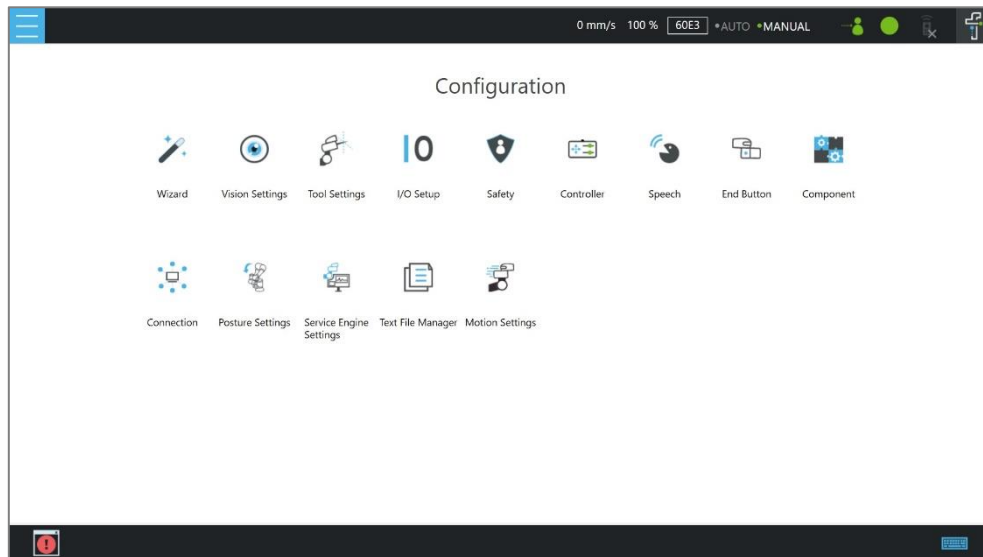

Figure 5 - 32: Configuration

### 1.27.1 Wizard

The **Wizard** will guide users through robot basic settings step by step, including language, time and date, network setting and speech setting.

### 1.27.2 Vision Settings

**Vision Settings** allows users to modify the camera parameters, calibrate the camera, and manage vision job image files on the **External Hard Drive**.

#### Note

#### NOTE:

The extra model management function presents if licensed for TM 3DVision.

### 1.27.3 Tool Settings

In **Tool Settings**, users can create a TCP through **FreeBot** teaching and Manual-inputting parameters. Refer to 1.36 Tool Settings for instructions.

### 1.27.4 IO Setup

In **IO Setup**, the **Default Output Value** of the output signal at the time of starting up, and the meaning represented by the **User-Defined IO** can be set. Using **User-Defined IO**, users can trigger or read the button on the **Robot Stick** with an external device through the IO port on the **Control Box**. Users can also change the serial port configuration on **Control Box** and **End Module** in **Serial Port**. If users wish to name certain IOs, then can do so in Custom IO Name to

give names to the IOs. After the setting is complete, click the **Save** button at bottom right to save the setting.

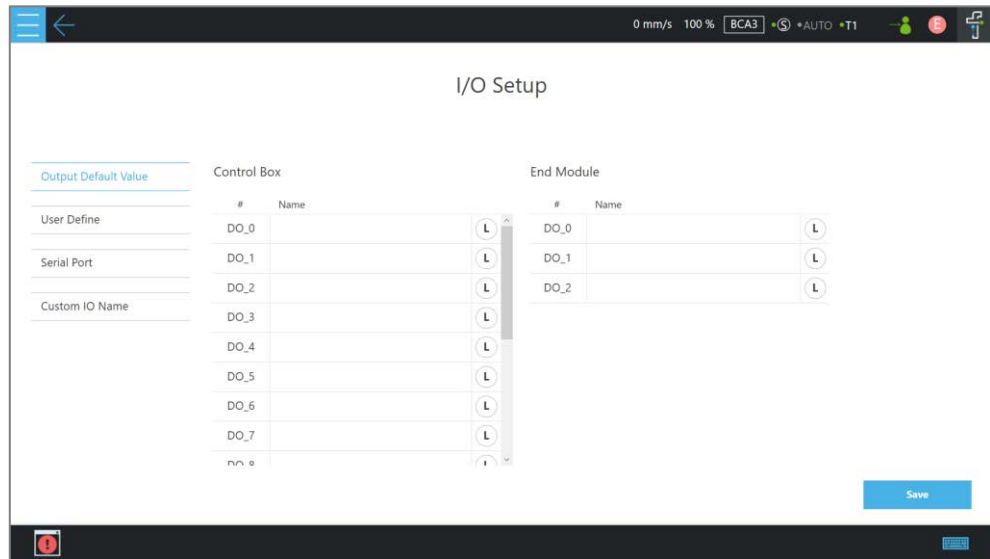

Figure 5 - 33: Output Default Value Setting

Control Box Input channel	Definition	Control Box Output channel	Definition
10	Stick + button	10	Stick + button
11	Stick - button	11	Stick - button
12	Stick Pause button	12	Stick Pause button
13	Stick Play button	13	Stick Play Button
14	Stick Stop button	14	Stick Stop Button
		15	System Error Indicator

Table 10: User Defined IO Setting Table



**NOTE:**

- Available serial port configurations vary from hardware versions. HW 3.2 does not support changing serial port configurations. For details of the pin assignment, refer to the section in the user manual of the respective hardware version.
- In Custom IO Name, the maximum number of characters in the name field is 50. The system will overwrite the default values if the modified pins come with the default values. Please ensure the correctness of the setting if changing to the external modules.

1.27.5 Safety

Refer to Chapter 0 Safety Settings for details.

1.27.6 Controller

Refer to F Controller for details.

### 1.27.7 Speech

In **Speech**, users can set the speech parameters, including the buzzer, speech function and error message broadcasting or not, broadcast language, speed and volume. To use the speech function, connect a speaker to the **Control Box**.

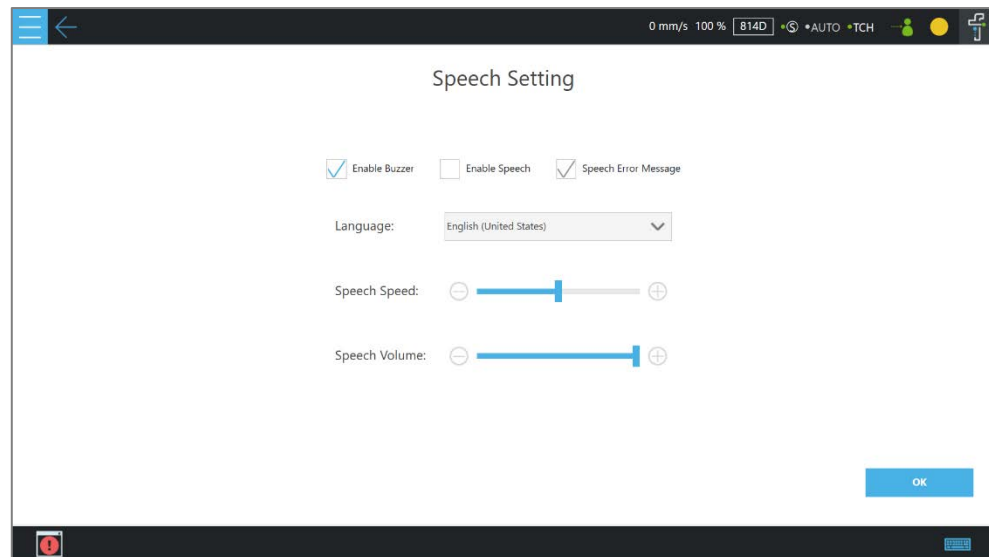

Figure 5 - 34: Speech Setting



**CAUTION:**

If using "**Speak and Move**", the speech will be saved into a buffer and deleted only if the system finished speaking it. That means, if the **Voice** is used in a **Thread** with a quick loop, the buffer size will increase quickly, that the robot might keep speaking without ever stopping.

### 1.27.8 End Button

In **End Button**, users can set the behaviors of pressing the **Gripper Button** and the **Vision Button** on the **End Module**.

For the **Gripper Button**, if the gripper used is a general I/O type gripper, click **Grip** to set the IO signal required to close the gripper. Click **Release** to set the IO signal required to open the gripper. If the gripper in use needs **TM Component** to operate, select the user-defined component. Refer to Chapter 0 Component for use of TM Component.

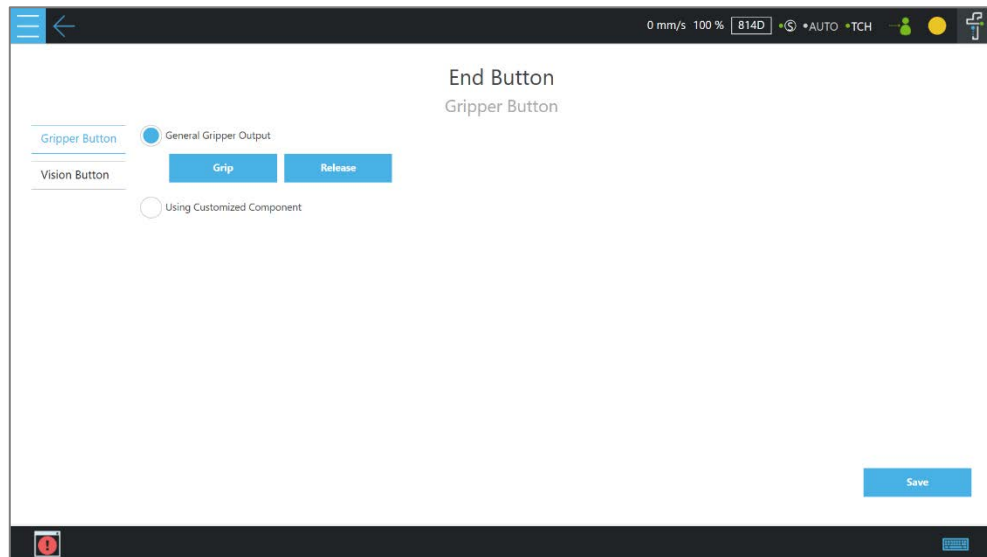

Figure 5 - 35: Gripper Button

To set the **Vision Button** for common vision jobs or **Smart-Pick**:

1. Navigate to ≡, and click **Setting**.
2. Click the **End Button** icon.
3. Click **Vision Button**, and click the bullet before **Vision Button** or **Smart Pick**.



**IMPORTANT:**

In the current version, the Script project does not support the Vision Button and the Gripper Button-Component.

### 1.27.9 Component

In **Component**, users can select the component to be started from the **Component List**. Refer to 0 Component and 0 TM Component Editor for details.

### 1.27.10 Connection

In **Connection**, users can set **Modbus Slave** related settings, **TM Ethernet Slave**, **Profinet Server**, and **EtherNetIP Server**. Make sure the card does secure to the designated slot and the cable does connect to the appropriate port before setting items in **Connection**.

For **Modbus Slave**, the system provides two Modbus communication methods: **Modbus TCP** and **Modbus RTU**. Click **Disable/Enable** switch icon on the top to turn on/off the mode. Once **TCP** is turned on, the system works as a **Modbus TCP** server for user configured clients with IP filtered and permissions to access robot data. If **RTU** is turned on, it is possible to access robot

data with configurations via serial connections. Click the **Code Table** button in the bottom left to open the Modbus slave encoding definition file.

To use TM **Ethernet Slave**, click **Disable/Enable** switch icon on the top to turn on/off the mode. Once turned on, the system works as a socket server for users to configure clients with IP filtered and permissions to access robot data. TM **Ethernet Slave** follows the protocol introduced in *Programming Language TMscript*.

To use **Profinet Server** or **EtherNetIP Server**, click **Disable/Enable** switch icon on the top to turn on/off the mode. Once turned on, the system works as a **Profinet Server** or **EtherNetIP Server** for robot data accessing. For **Endianness**, users can click on the respective bullet to place the most significant byte first and the least significant byte last with **Big-endian** or the opposite with **Little-endian**. To check the data table, click the **Code Table** button.

To use the **Profinet Server** or **EtherNetIP Server** functions in **Expression Editor Setting**:

1. Click **Expression Editor > Connection**, and select **Profinet** or **EtherNetIP** in the menu.
2. Select the desired item in the **Function** dropdown.



**NOTE:**

When turning on **Profinet Server** or **EtherNetIP Server**, if a message prompts users

- for the listed field bus is enabled, please disable the current activated field bus before changing the setting.
- for rebooting the robot, please power cycle the robot to change the firmware of the field bus device and manually enable the target field bus in the setting again.
- for failed to activate device, please check the device and the driver are both installed correctly.

### 1.27.11 Posture Settings

**Posture Settings** provides a convenient tool for users to quickly move the robot to a commonly used pose. They are **Packing Pose**, **Normal Pose**, and **Home Pose** from top to bottom.

**Packing Pose** can reduce the space occupied by the robot to help users pack and transport the robot. **Normal Pose** is the most common work starting pose of the TM Robot, and **Home Pose** is the pose with all joint rotation angles are 0 degrees.

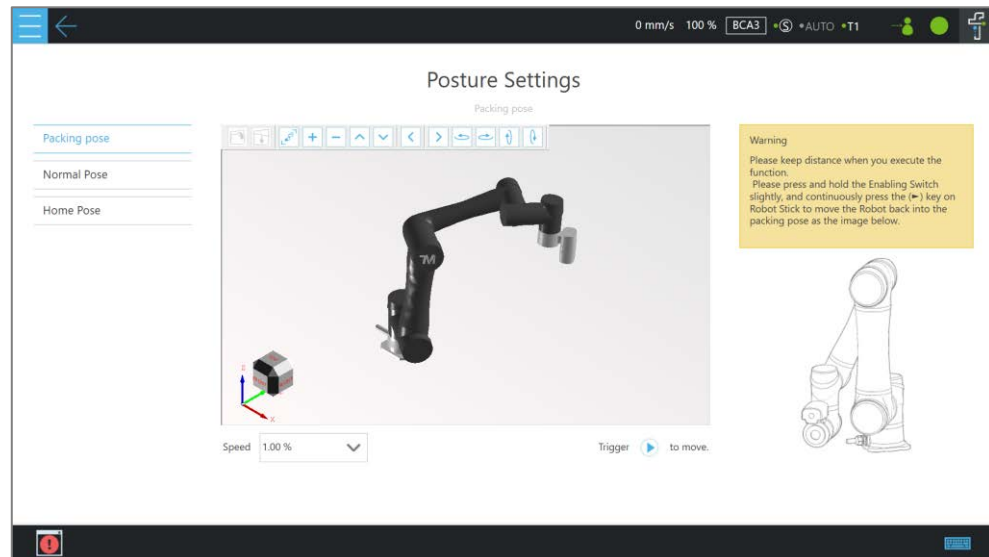



Figure 5 - 36: Posture Settings

### 1.27.12 Service Engine Settings

In **Service Engine Settings**, users can send robot data to the Service Engine Settings at a remote site to make use of the data.

To start send robot data to the Service Engine Settings at a remote site, follow the steps below.

1. Navigate to , and click **Configuration**.
2. Click the **Service Engine Settings** icon.
3. Check **Enable Service Engine Settings**.
4. If required, check **Enable auto upload data to server** for the remote site to obtain the IP setting and the related parameters of the robot.
5. In the fields below **Server Setting**, fill the IP address and port number of the remote site.
6. Click **Save** when done.

### 1.27.13 Text File Manager

The **Text File Manager** contains a list of **Text Files** and **IODD Files** that have been imported to the control box. String variables from the **Variables** menu can be used to read data from imported text files. **Array**, **Global Variables**, and **Variables** of other types do not support this feature.

In **Text Files**, users can use the preview window as a simple text editing tool. Select the text file in the list to view the context of the text file in the preview window. Click the **Edit** button to set the preview window to edit mode for simple content modification.

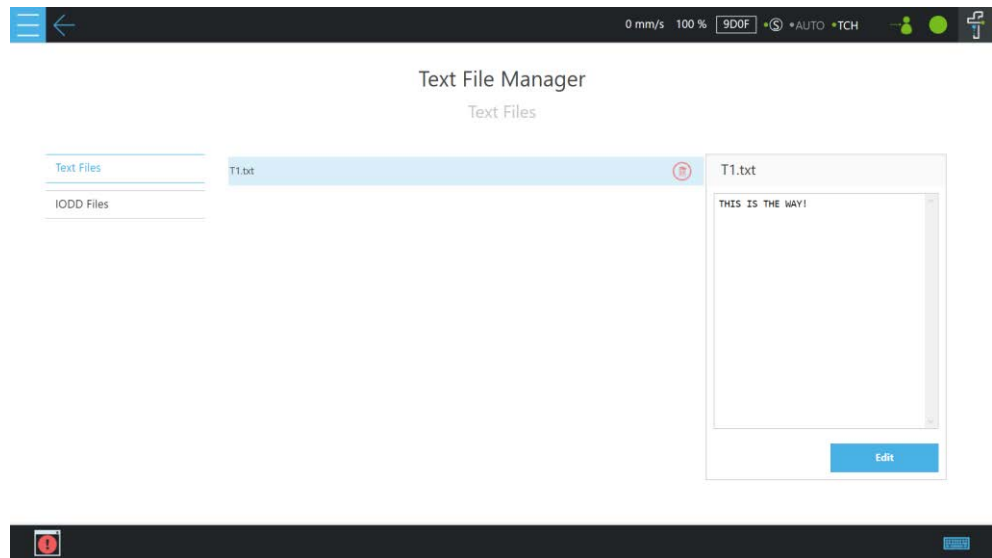

Figure 5 - 37: Text File Preview



- NOTE:**
- File name modification is not supported.
  - Adding new files is not supported.

#### 1.27.14 Motion Settings

In **Motion Settings**, users can set **Speed Suppression** to have the robot adjust its rate of motion by the custom-values of the Safety Tool Speed Limit and the Joint Speed Limit. Refer to the formula of **Target Speed** to input the values in the fields next to **A,B** and **C,D**, and click **SAVE** when done.

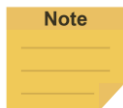

- NOTE:**
- HW 3.2 does not support the joint speed suppression function.

The robot goes with a varying scale of speed fluctuations at different settings of motion speed. The speed fluctuation, in general, will be minor in low motion speed and massive in high motion speed.

- **A,C** stands for the tolerance value of the speed fluctuation in the low Safety Tool Speed Limit or the Joint Speed Limit while the robot is in low motion speed.
- **B,D** stands for the tolerance ratio of the speed fluctuation in the high Safety Tool Speed Limit or the Joint Speed Limit while the robot is in high motion speed.





**NOTE:**  
To avoid setting the speed off the limit, value **A,C** adapts better in the low Safety Tool Speed Limit or Joint Speed Limit, and value **B,D** in the high Safety Tool Speed Limit or Joint Speed Limit.

The custom-values of Safety Tool Speed Limit and the Joint Speed Limit refer to **Configuration>Safety> Speed & Force>Performance Safety** and **Configuration >Safety> Speed & Force>Human-Machine Safety** for the normal and the collaborative operation, respectively.



**NOTE:**  
The **Speed Suppression** function is always enabled. The system will adjust the motion speed of nodes automatically to the limit value of Safety Tool Speed and Joint Speed set by users on the Safety Settings page. These nodes include Point Node, Circle Node, Pallet Node, Move Node, F-Point Node, Touch Stop Node (Line), Vision Node (Fixed Point), Vision Node (Servoing), and Path Node.

In **Motion Settings**, users can set **Deceleration Time** when any Human-Machine Safety Settings function is triggered. When the robot enters the collaborative operation or the collaborative workspace, the system achieves the speed setting in the set time value.



**NOTE:**  
Users can set the deceleration time manually in the field when the robot enters the collaborative operation or the collaborative workspace. The system achieves the speed setting within the time as below.

	<b>TM7S/TM5S</b>	<b>TM12S/TM14S</b>
<b>Default</b>	150 ms	300 ms
<b>Available range</b>	150~800 ms	300~800 ms

## 1.28 System Setting

**System Setting** includes settings related to this software. From left to right and from top to bottom, they are: **Language**, **System Update**, **User & Permission**, **Network**, **Import/Export**, **Date and Time**, **Network Service**, **Backup and Restore**, **Remote Control Setting**, **Hard Disk Space**, and **Data Transfer**.

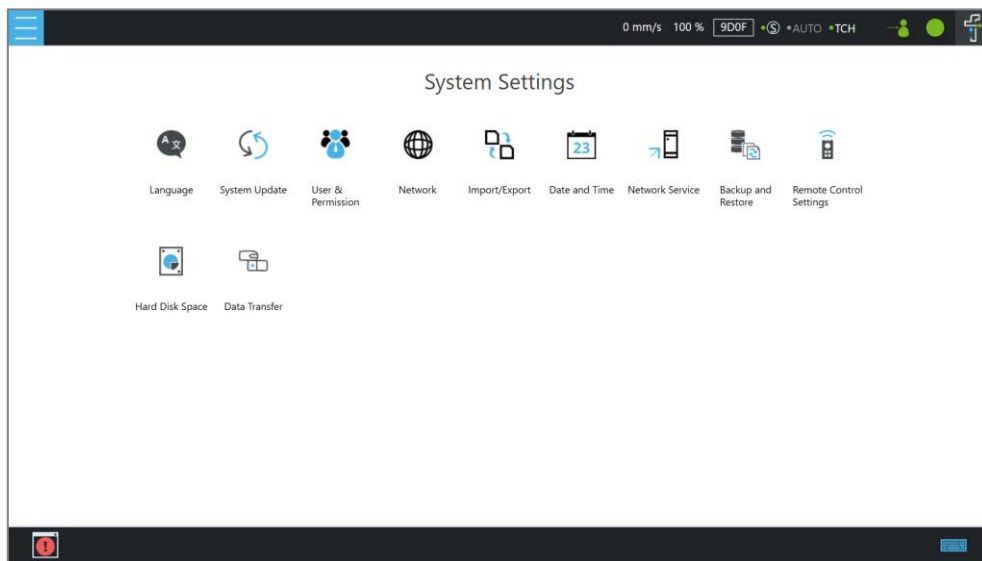



Figure 5 - 38: System Settings

### 1.28.1 Language

Select the icon of the language to display on the system. Click  to update with the language pack if available.

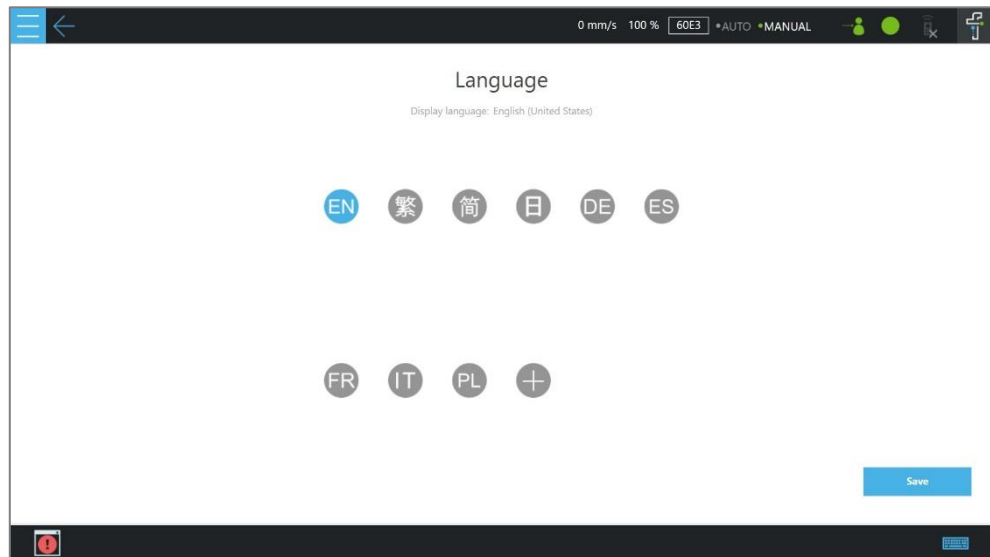

Figure 5 - 39: Language Setting

### 1.28.2 System Update

To update the **TMflow** on the robot, users need to download and unzip the update files from the website of the Company. Then, place all the content generated from the unzipped files into the root directory of the USB flash drive labeled with **TMROBOT** as shown.

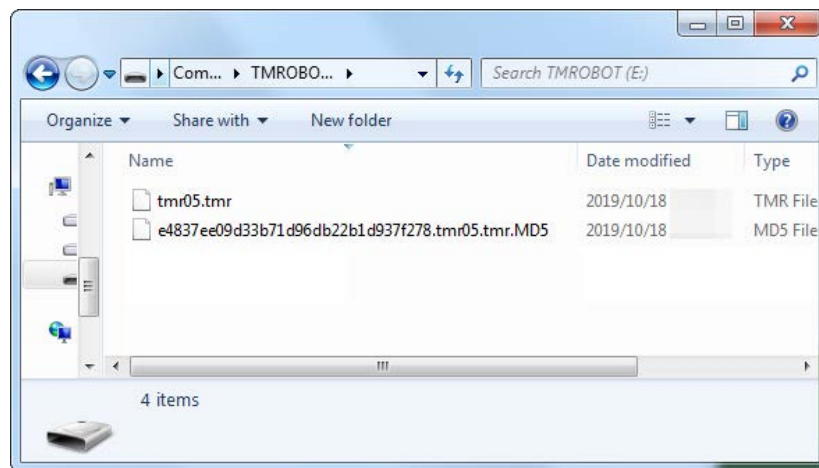

Figure 5 - 40: System Update (1/2)

Plug into the USB port on the **Control Box**, select **USB\TMROBOT**, and click the **Update** button at the bottom the **System Update** page to start the update.

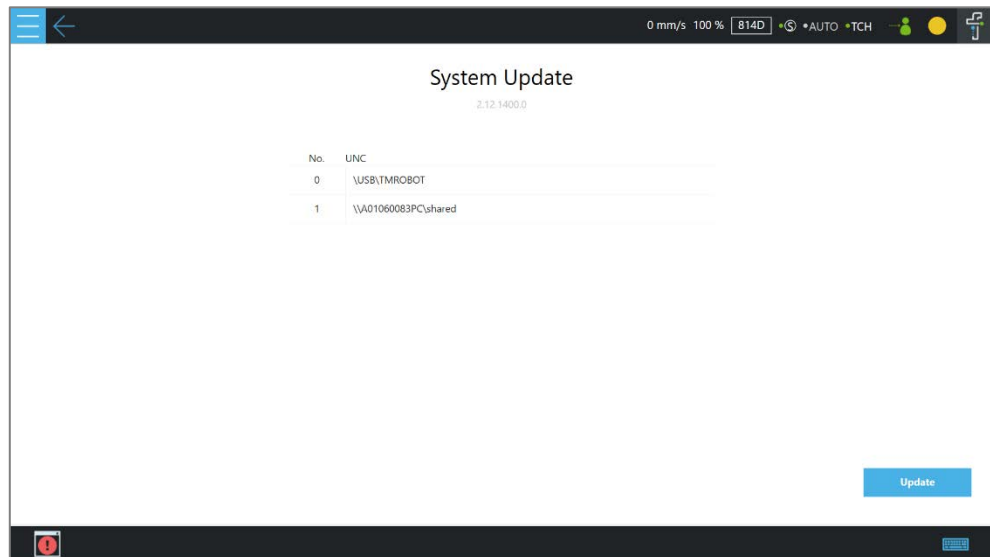

Figure 5 - 41: System Update (2/2)



**NOTE:**  
Users can add network resources in **Network Service** to make the connection path list under **Device/Network** and update the system via the network with good connection quality.

### 1.28.3 User & Permission

In **Administrator**, users can change the administrator password. The default password is blank. To ensure the security of robot use and data, change the password after the first login.

The **Default Login Account** defaults to **Administrator**. However, users can assign the **Default Login Account** by clicking the dropdown below. The list in the dropdown comes with **Administrator** and the sorted accounts by the date created. Once the assigned **Default Login Account** having deleted, the **Default Login Account** sets to **Administrator**.

Click **Save** to apply.

In **User Account**, users can create the **User Account**. Enter the **Name** and the **Password** in the right pane to **Add User**. Users must select the **Group** to set the access permissions when creating the **User Account**. After creating the **User Account**, click the pencil icon to modify the user information or delete the user.

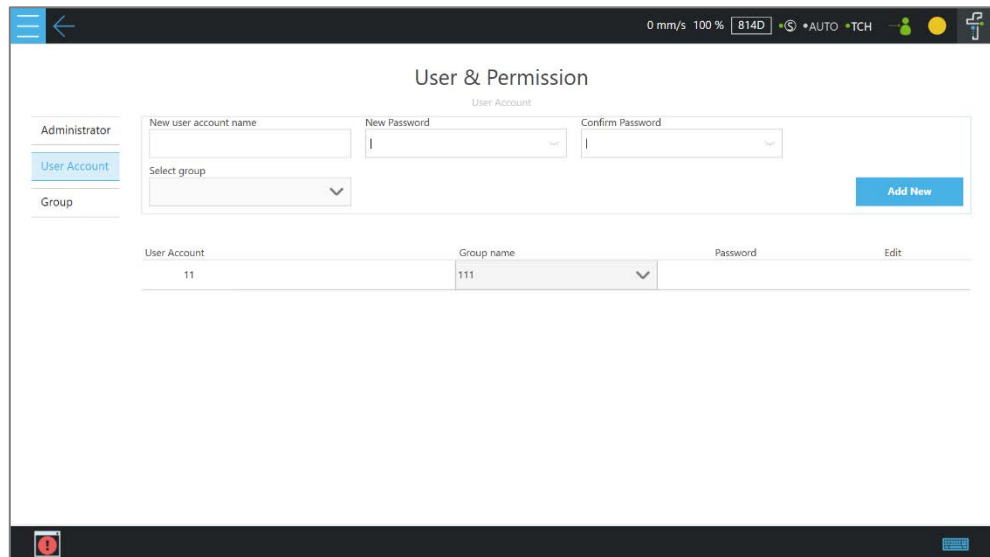

Figure 5 - 42: User Account

In **Group**, users can create the user group. Enter the **Group** name in the top pane, and select the scope of this **Group's** permissions, including project, project lock setting, view, system, configuration, and project override speed. Press **Add New** after completing settings to create the **Group**. After creating the **Group**, click the pencil icon to modify the group information or delete the group.

#### 1.28.4 Network

In **Network**, the current connection status will be displayed. Click the item to set its parameters. If users choose **Get IP from DHCP**, the current connection IP will be grayed out. Users can also customize the connection name by the application.

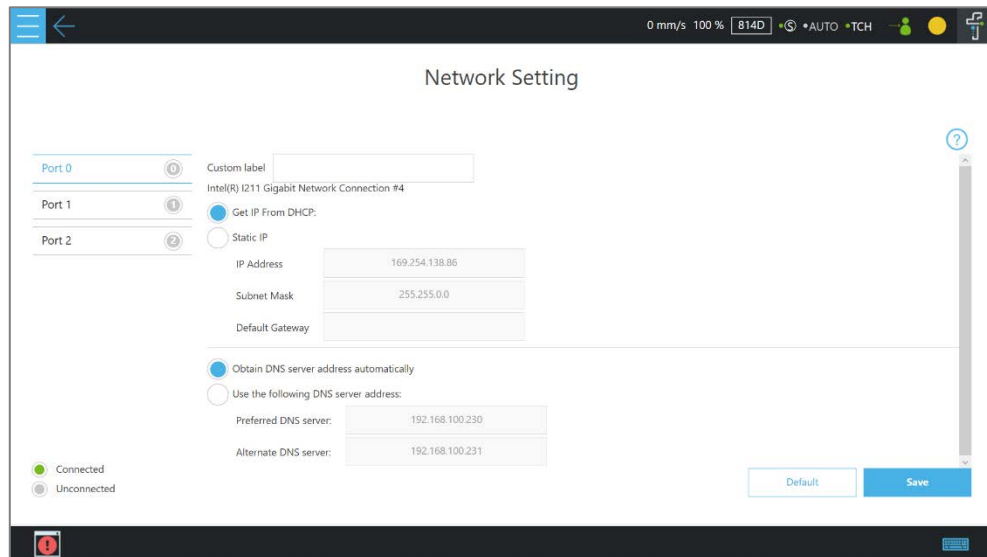
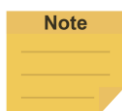

Figure 5 - 43: Network Setting

### 1.28.5 Import/Export

In **Import/Export**, users can import items from the flash drive or export items to the flash drive. The label of the flash drive must be **TMROBOT**. Insert the flash drive to the Control Box before using the function.

- To use the Export function:  
Click the **Export** button at the top left, and then select the desired file in the **Select file** box. Click the item in this box to add the item to the **Selected files** box. After completing the new addition, click **Export** at the bottom right to start the **Export** procedure.
- To use the Import function:  
Click on the **Import** button at the top left, select the robot of the data source in the flash drive from the robot list, and then select the desired data from the **Select file** box. Click an item in this box to add the item to the **Selected files** box. After completing the new addition, click **Import** at the bottom right to start the Import procedure.



**NOTE:**

While using **Import/Export**, if there are duplicated **Project** files in the **Selected files** box, after clicking either **Import** or **Export** at the bottom, users can choose from **YES** to overwrite, **NO** to save as, or **CANCEL** to cancel the Import or Export. Checking the box next to **Apply to all folders** will apply YES (overwrite) to all remaining duplicates.

Available data types to import or export:

- **Project: Whole Project, Point, Base, Modbus, F/T Sensor, Global Variable, Path,**

## Motion Record

- **Configuration: TCP, Component, Operation Scene, Text Files, IODD Files, Ethernet Slave, Safety Configuration Files.**
- **System: Log, Hardware Record, Network Service, Backup File**

Examples:

<ul style="list-style-type: none"><li>● To export the settings relative to the F/T sensor along with the project:</li></ul>	<ul style="list-style-type: none"><li>● To import the settings relative to the F/T sensor along with the project:</li></ul>
<ol style="list-style-type: none"><li>1. Navigate to ≡, click <b>System</b> &gt; <b>Import/Export</b>.</li><li>2. Click <b>Export</b> on the top left, and click <b>Project</b>.</li><li>3. Select the name of the project to export in <b>Select Files</b>. Once selected, the project to export will be listed in <b>Selected Files</b>.</li><li>4. Repeat Step 3 if you wish to select more projects to export.</li><li>5. Click <b>Export</b> at the bottom right to export projects when done selecting.</li></ol>	<ol style="list-style-type: none"><li>1. Navigate to ≡, click <b>System</b> &gt; <b>Import/Export</b>.</li><li>2. Click <b>Import</b> on the top left, and click <b>F/T Sensor</b> at the bottom left.</li><li>3. Select the robot to apply the imported setting in the <b>Robot List</b> prompted and click <b>OK</b>.</li><li>4. Select the project to apply the imported setting in the <b>Project List</b> prompted and click <b>OK</b>.</li><li>5. Select the project to import in the <b>Import Project List</b> prompted and click <b>OK</b>.</li><li>6. Select the name of the setting listed in <b>Selected Files</b>.</li><li>7. Click <b>Import</b> at the bottom right to import the setting.</li></ol>

Note

### NOTE:

- The exported backup file will be compressed and encrypted.
- The backup file will be exported to the path as below.  
**\TM\_Export(Computer Name+ Robot ID)\Backup**
- Computer ID and Robot ID will be checked while importing backup files.
- The number of the backup files on the system is limited to 5. Delete the backup files on the system if unable to import backup files.

## 1.28.6 Date and Time

In **Date and Time**, users can change the date and time of the system as well as set the time zone with the option to enable daylight saving.

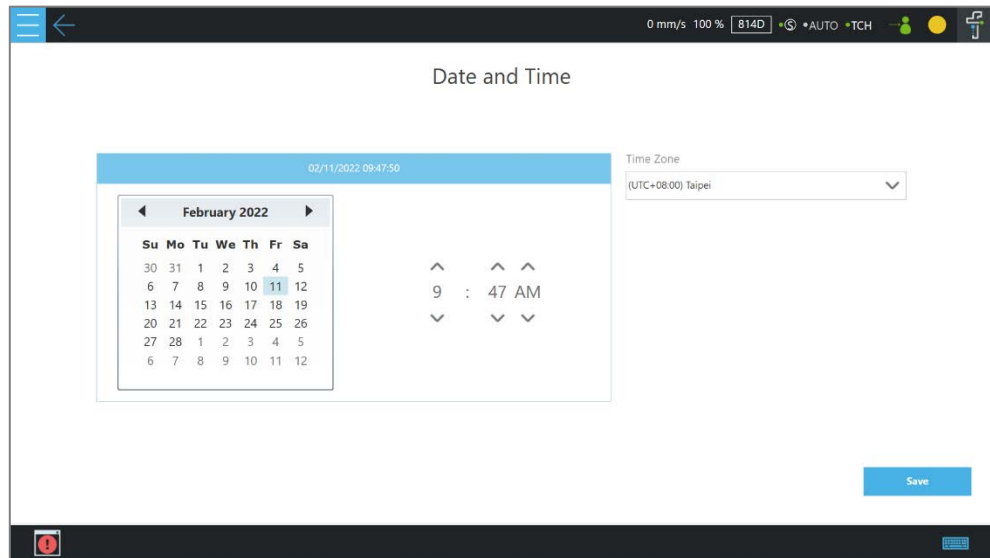



Figure 5 - 44: Date Time

### 1.28.7 Network Service

In **Network Service**, users can upload logs, robot data, and vision images to a remote host on a timely basis with multiple connections and accounts.

To go to **Network Service**, navigate to , and click **System > Network Service**.

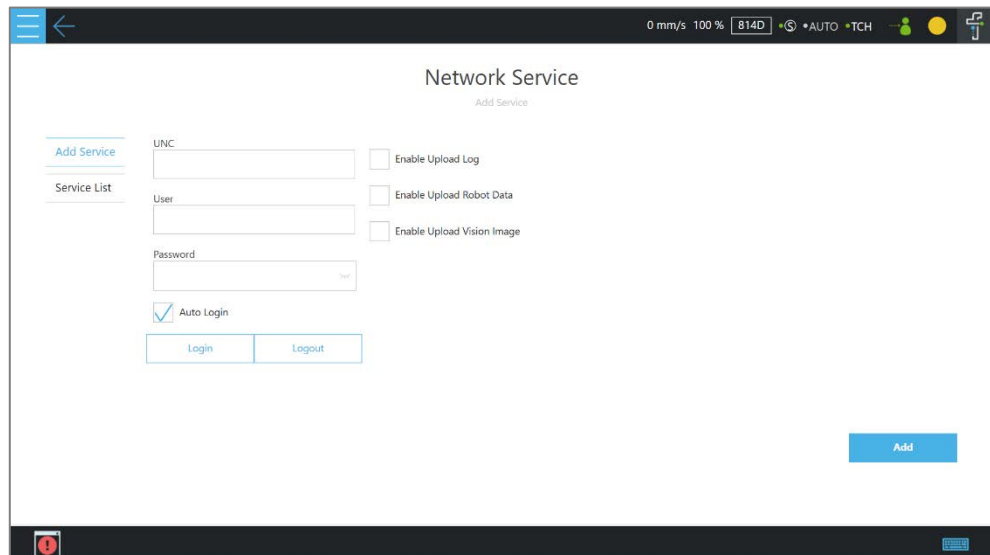

Figure 5 - 45: Network Services

To set the remote host to upload, follow the steps below.

1. In the **UNC** field, use the uniform naming convention to input the address of the remote host. If authentication is required, input the user account and the password in the respective



fields. Check the eyelash icon if users wish to see the password in plain text. Use **Login** and **Logout** to test the connection.

2. Check **Auto Login** if you wish to establish the connection when the system is on.
3. Select items to upload by checking the respective boxes, and set the interval or a specific time to upload. Check **On Error** if users wish to upload when an error occurred.
4. Repeat step 1 through 3 if users have other hosts to upload.



**NOTE:**

Users can set FTP protocol for the connection in the **UNC** field, for example:  
<ftp://192.168.1.100:99>.

- **192.168.1.100:99** denotes the resource IP address and the port number.

To start a project to upload to the remote host, follow the steps below.

1. Navigate to ≡, and click **Project**.
2. Start a new project or open an existing one.
3. Drag a log node to the workspace, and click the pencil icon of the node.
4. In the **Save Device** field, select the desired item in the dropdown menu, and set the directory to upload in the **Save Directory** field. Click **OK** when done.
5. Make sure the nodes in the workspace are connected properly, and run the project.



**IMPORTANT:**

The TM SSD is a requisite for using **Network Service** with TM 3DVision to upload images.

### 1.28.8 Backup and Restore

This function has users back up and restore the current **TMflow** version with projects, TCPs, robot parameters, and all other contents. Click the **Backup** button to generate a backup file. After upgrading the TMflow version, users can use the restore function to restore the previous version and the file content. When executing the Restore function, it will show a window and display "**After restoring the backup file, the current data will be removed. Do you want to restore the backup file? (Yes / No)**". Click **Yes** or **No** to proceed.

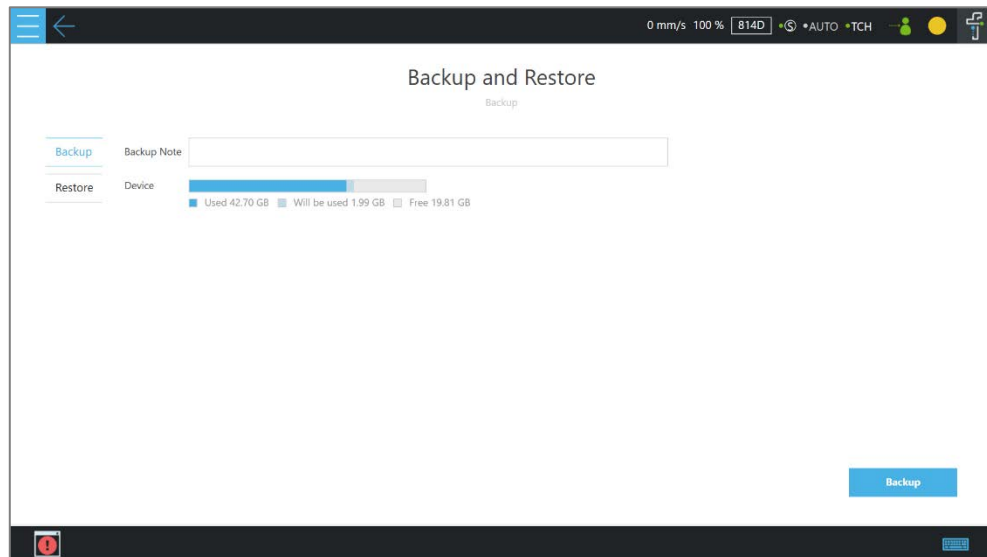

Figure 5 - 46: Backup\Restore



**IMPORTANT:**

The number of backup files is limited to five.

### 1.28.9 Remote Control Settings

Users can use **Remote Control Settings** to enable the remote control input function with **IO** or **Fieldbus**. Check the box before the desired item, and click **Save** to apply.

### 1.28.10 Hard Disk Space Analysis

In **Hard Disk Space analysis**, the storage space of the robot displays as a bar graph. When the available storage space is lower than 10 GB, users can go to the management page of each project (text/xml files, projects, AI models, log files, backup files) to delete the specific item of data or click the Clean button in the **Hard Disk Space analysis** page to remove log files for three days old and older.

### 1.28.11 Data Transfer

Users can use **Data Transfer** to export or import settings and configurations from one robot to another.

- To export from a robot:
  1. Click **Export** at left, and input the Data Transfer Name in the respective field.
  2. Select the location to export in the dropdown next to Device.
  3. Click the **Export** button at bottom right to begin the data transfer.

- To import to a robot:
  1. Click **Replace** at left, choose the desired robot to import in the list, and click **Select**.
  2. Select the desired Data Transfer Name.
  3. Click the lock icon, and input the safety configuration tool password.
  4. Click the **Replace** button at bottom right to begin the data transfer.

Note

**NOTE:**

No data transfer will complete if there is any mismatch between the versions of TMflow, hardware, or safety system.

## Point and Base

### 1.29 Overview

In the projection of any point in three-dimensional space is the position of the point on the **Base**.

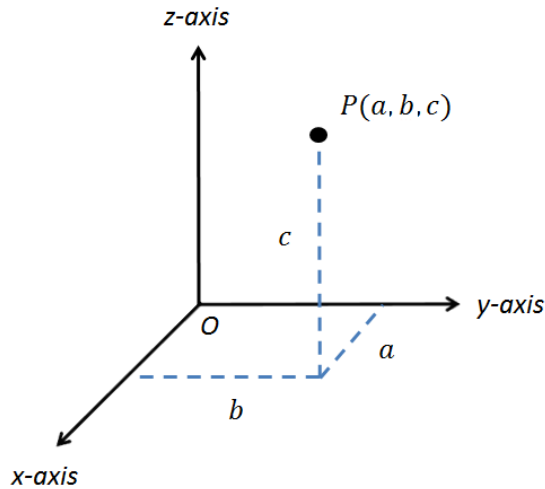

Figure 6 - 1: Base Value of the Point

To describe a point, in addition to X, Y, Z coordinate positions, it is also necessary to define its direction in the space  $R_x, R_y, R_z$  to describe the posture of the point in the space.

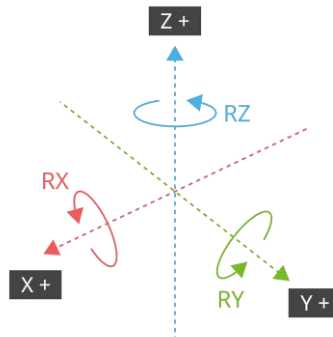

Figure 6 - 2: Coordinate Axis Rotation

The **Base** is a system that defines the corresponding position and posture of the robot in three-dimensional space. In the TM Robot, **Base** is divided into four categories: **Robot Base**, **Custom Base**, **Tool Coordinate**, and **Vision Base**.

This Chapter will introduce the basic direction judgment method for the **Base** first, and define the physical meaning of the **Robot Base**, so that users can understand the **Base** of robot, and use the controller system to move the robot in the specified **Base**. Finally, how to convert between different **Bases** will be introduced, which is for users to complete the work flow without reprogramming the

project in the situation of absolute position changes while relative positions do not change.

## 1.30 Base and Right-hand Rule

### 1.30.1 Right-hand Rule

The Right-hand Rule is a method of determining the direction of the three-dimensional **Base**. In the system of **Base** of robot, the right-hand coordinate system can be used to determine the positive direction of the Z-axis, as shown in the illustration, the thumb, index finger, and middle finger represent the right hand coordinate X-axis, Y-axis, and Z-axis respectively, and three fingers are perpendicular to each other. In addition, the Right-hand Rule also determines the positive rotation direction of the coordinate axis in the three-dimensional space, bending finger. The direction pointed by the finger is the positive rotation direction of the coordinate axis.

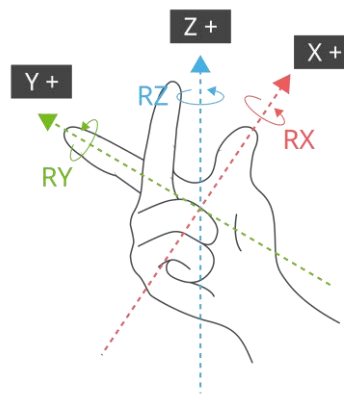

Figure 6 - 3: Right-Hand Base

### 1.30.2 Types of Base

The **Bases** defined in the robot are **Robot Base**, **Custom Base**, **Vision Base** and **Tool Coordinate** according to the purpose. Users can complete the point planning and application in the space using intuitive methods, according to these different base applications.

#### 1.30.2.1 Robot Base

**Robot Base** is also called the world coordinate system. It is defined as the **Base** of the robot. When the robot is running, no matter how the position or posture is changed, it will not affect the direction and position of the initial point of the coordinates.

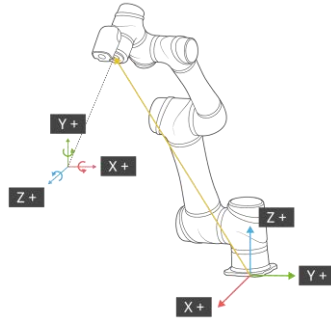

Figure 6 - 4: Robot Base

### 1.30.2.2 Vision Base

**Vision Base** can be further divided into visual servoing positioning and fixed-point positioning. The concept of visual servoing positioning is to approach the object with camera, so the **Base** is created on the camera. In fixed-point positioning, the relationship between the image coordinate and the robot is known to calculate the positioning object with absolute coordinates and its **Base** is created on the object.

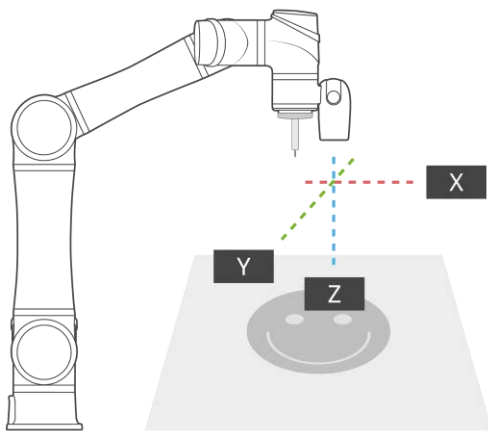

Figure 6 - 5:  
Servoing Vision Base is on the Camera

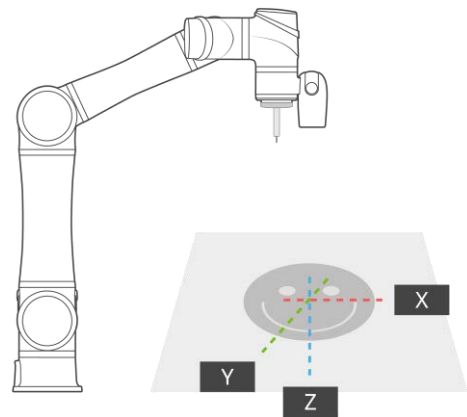

Figure 6 - 6:  
Fix-point Vision Base is on the Object

The robot's vision can be simply built with the **Base** in parallel to the operation plane, allowing users to complete assembly, processing, and other related applications on an inclined plane, and can also use the **Vision Base** to position the robot in the space.

### 1.30.2.3 Custom Base

The **Custom Base** provides users with a method for creating the reference **Base** of the

motion node. Users can jog the robot to move to the origin, any point on the X-axis and XY planes of the **Base**, to create a **Custom Base**, refer to 1.33 Create a Custom Base for details.

#### 1.30.2.4 Tool Coordinate

**Tool Coordinate** is used to define the position and orientation of the robot **TCP**. Before using the **Tool Coordinate**, the orientation and posture of the **TCP** must be defined (refer to Chapter 0, "Create "). If the **TCP** is not defined, the flange center point will be used as the origin of the **Base**. In the same project, if the tool is worn out or the tool is changed, users only need to redefine the **Tool Coordinate** without having to reprogram the flow.

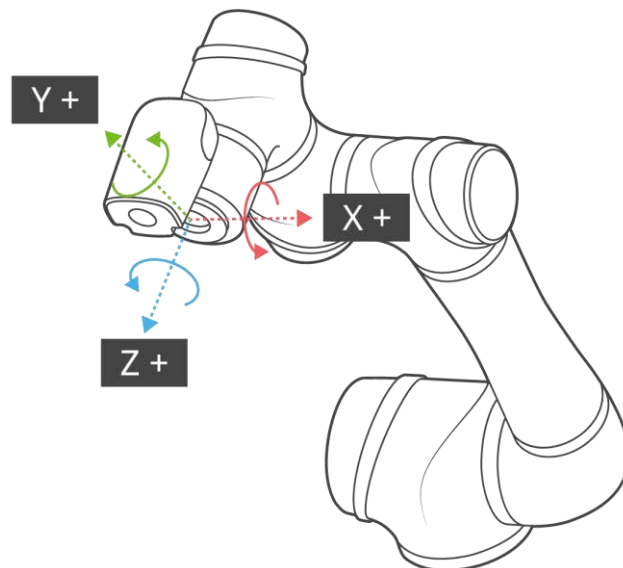

Figure 6 - 7: Tool Coordinates

#### 1.31 Point Parameter

For the robot-defined Point Parameter, in addition to defining the position and orientation of each point, it will also regulate the recorded **Base** of each point and the tools it applies to. If the tool it applies is **T0**, represents **No Tool**.

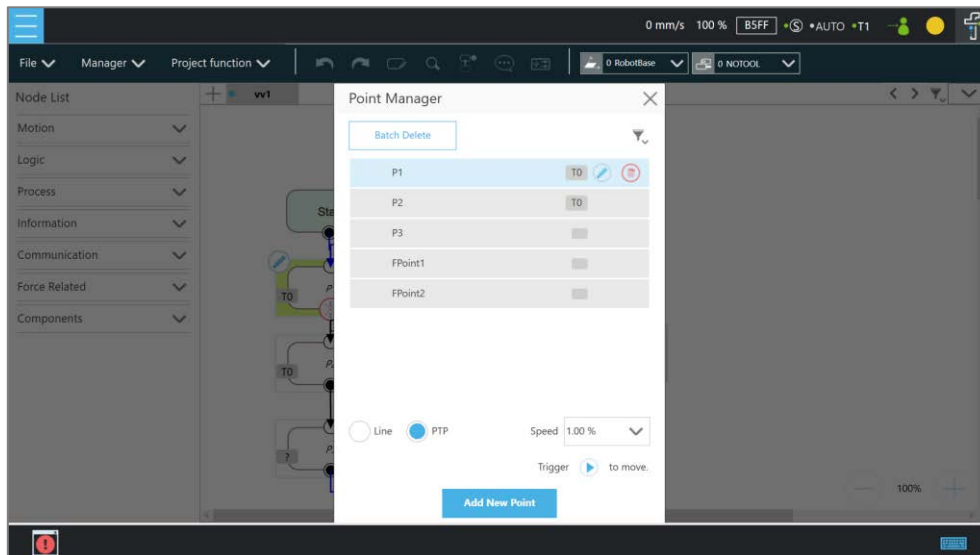

Figure 6 - 8: Point Parameter Information

If users need to apply different tools on the same flow project, or perform the same operation on different operation planes, different information can be reassigned to the created point. This section explains the advanced settings in the **Point** node as an example, this setting can be divided into two categories of **Base Shift** and **Tool Shift** to modify the **Base** of point and the tool applied.

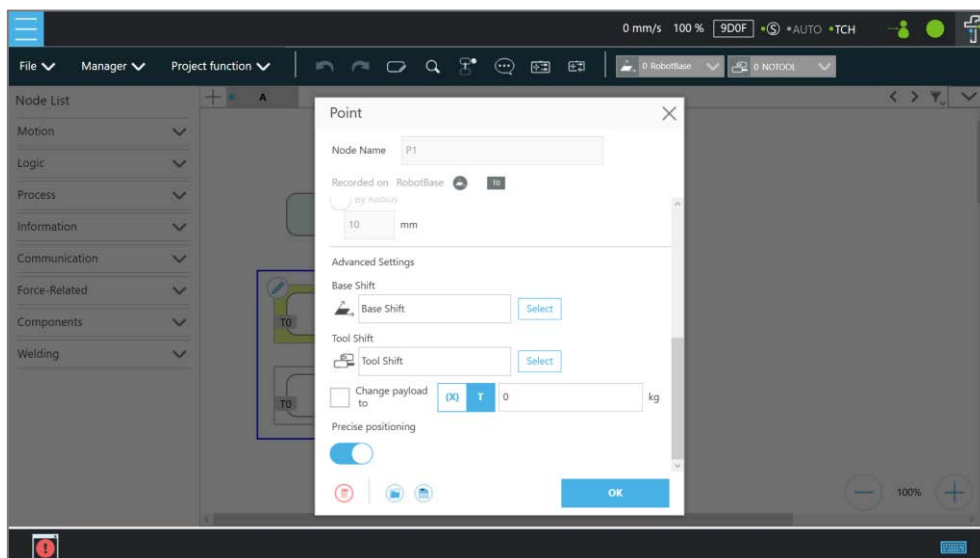

Figure 6 - 9: Shift Function of Point Node

### 1.31.1 Base Shift

The **Base Shift** is to transfer the point to another **Base** without changing the position and orientation of its relative **Base**. In this example, the coordinate is rotated, translated, to convert to another **Base**. In this new **Base**, the position and orientation of the point relative to its reference



**Base** is not changed. In the case of change in absolute position, the relative position is maintained. This function allows users to complete the same job on different **Bases**.

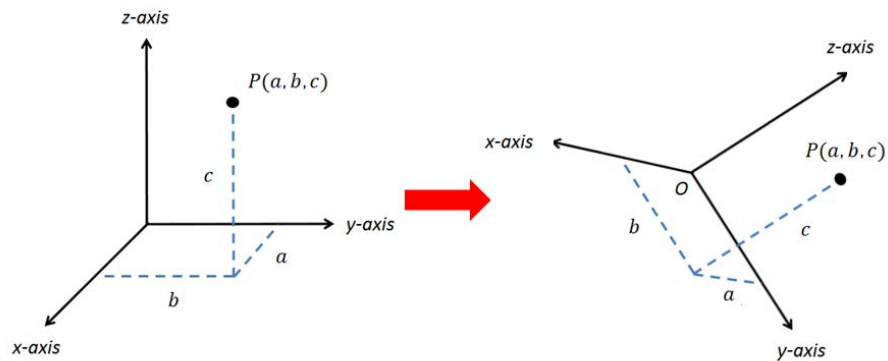

Figure 6 - 10: Base Shift Schematic Diagram

Record point P1 on Base 1. At this time, use the **Base Shift** to change the reference coordinate of the point to the new base, Base 2. This operation will not modify the data of original point, only valid for this set node, and the modified node **Base** will be presented within a pink box.

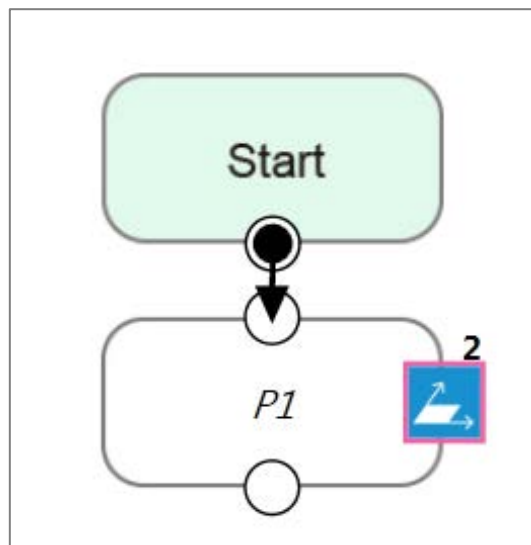

Figure 6 - 11: Node with Base Shift



**IMPORTANT:**

This function is different from re-record on another base in the **Point Manager**. The function of re-record on another base is to present the position and orientation of the point with respect to another **Base**. Therefore, the absolute position of the original point is not changed.

Note

**NOTE:**

- **Base Shift** works on Robot Base, Vision Bases, and Custom Bases for motion nodes.
- **Base Shift** or **Tool Shift** does not reset after importing points from existing points in the node.
- **Base Shift** or **Tool Shift** is possible to shift to the current base or the current tool.

### 1.31.2 Tool Shift

Record point P1 on T1. At this time, use **Tool Shift** to change the tool T1 applied to P1 to tool T2. In practical applications, this function can be used if the tool is worn out or the same path is completed using different tools. This function is divided into two categories: **Keep Pose** and **Keep Path**. The same as the **Base Shift**, this operation does not modify the data of the origin position, is only valid for this set node, and the tool icon of the modified node will be rounded with pink borders.

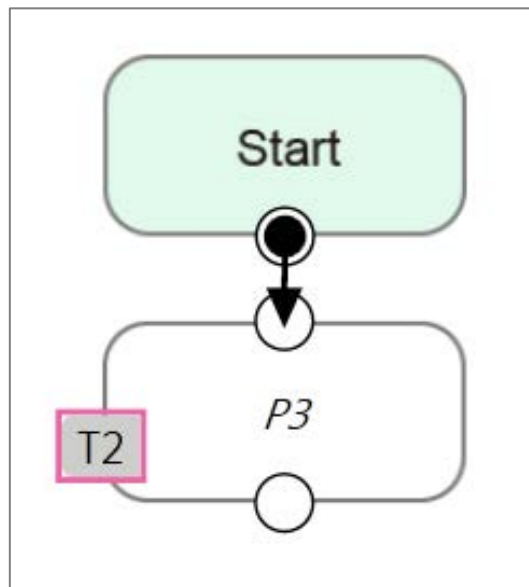

Figure 6 - 12: Node with Tool Shift

- **Keep Pose:** If the tool selected when the robot records the path is incorrect, the **Keep Pose** function of **Tool Shift** can be used to substitute the correct tool parameters of this node. This setting will not cause changes to the robot's pose and position, that is, it overlaps with the original track when running the project.

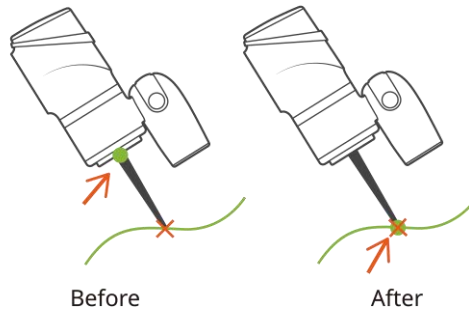

Figure 6 - 13: Tool Shift Using Keep Pose

- **Keep Path:** The robot will try to make the point recorded with the new tool the same as the old tool's point, and further change the robot's pose to conform to the new tool's setting; however, it may not be achieved due to space or robot mechanism limitations.

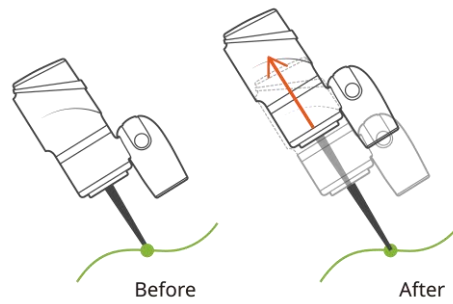

Figure 6 - 14: Tool Shift Using Keep Path

## Create Base

### 1.32 Create Vision Base

**Vision Base** can be generated through **Vision** Node in the flow project based on the target object or the camera by the chosen method.

### 1.33 Create a Custom Base

In a flow project, users can click on the Base Manager above the Project Editing Page. Users can use three points to create a new **Base**. Since the information of each point is recorded on the **Base**, only three points need to be redefined when changing the work plane. It is possible to implement the motion on another plane without reprogramming.

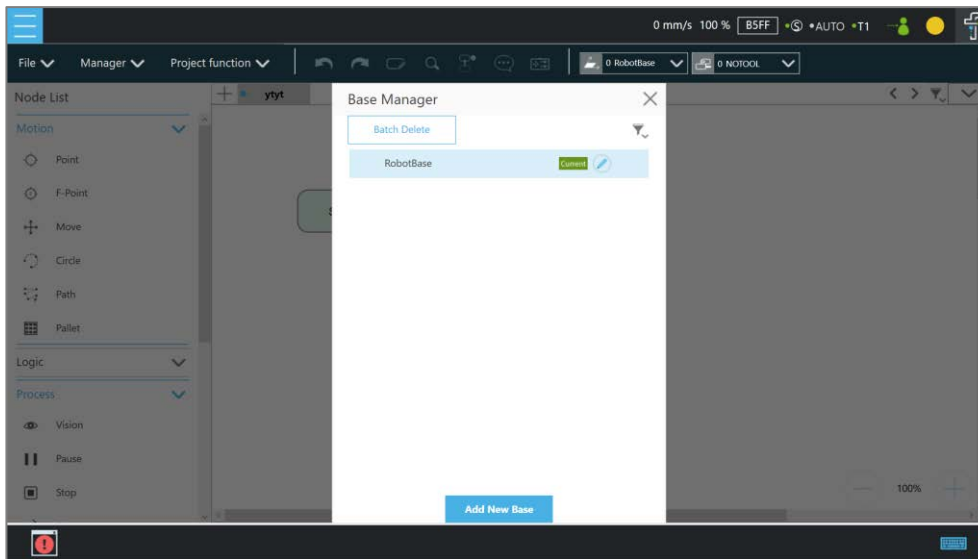

Figure 7 - 1: Base Manager

There are three buttons in the center of the three-point **Base**. From left to right, they are **Set the Base Origin**, **Set any Point on X-axis of the Base**, and **set the Base on any Point on the Positive X - Positive Y Plane**. Refer to 1.30 Base and Right-hand Rule to use the **Base** correctly.

Users can use the controller button below to enable the controller to operate the robot, or use the **FreeBot** mode to pull the robot to the target position (“Pointing 0,0,0”, “Point on X-axis”, “Point on Surface”). Pressing the corresponding button at this time will record the robot's current position at this point. After the setting is completed, the exclamation mark in front of the button will disappear. Once all three points are set, press **OK** to create the **Base**.

## Note

### NOTE:

#### Build a **Base** by 3 Points

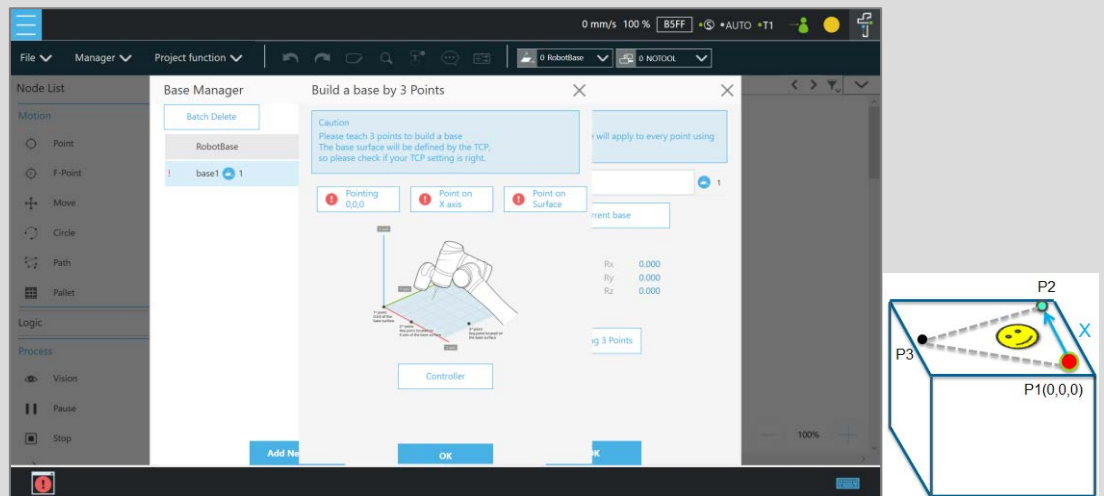

Figure 7 - 2: Build a Base by 3 Points

There are 3 buttons representing the 3 points which define a base, i.e. **Origin (0,0,0)**, **Point on X-axis**, and **Point on Surface**, refer to 1.30.1 Right-hand Rule.

Users can use the controller button below to enable the controller to operate the robot, or use the **FreeBot** mode to pull the robot to the target position (Pointing 0,0,0, Point on X-axis, and Point on Surface). Press the corresponding button at this time will record the robot's current position at this point. After the setting is completed, the exclamation mark in front of the button will disappear. After all three points are set, press **OK** to create the base. This point is the TCP point.

### 1.34 Create New Base Node

In the flow project, drag the **New Base** Node from the left side. After clicking Edit on the upper left of the node, users can select to create a new base with vision bases or create a new base with three points.

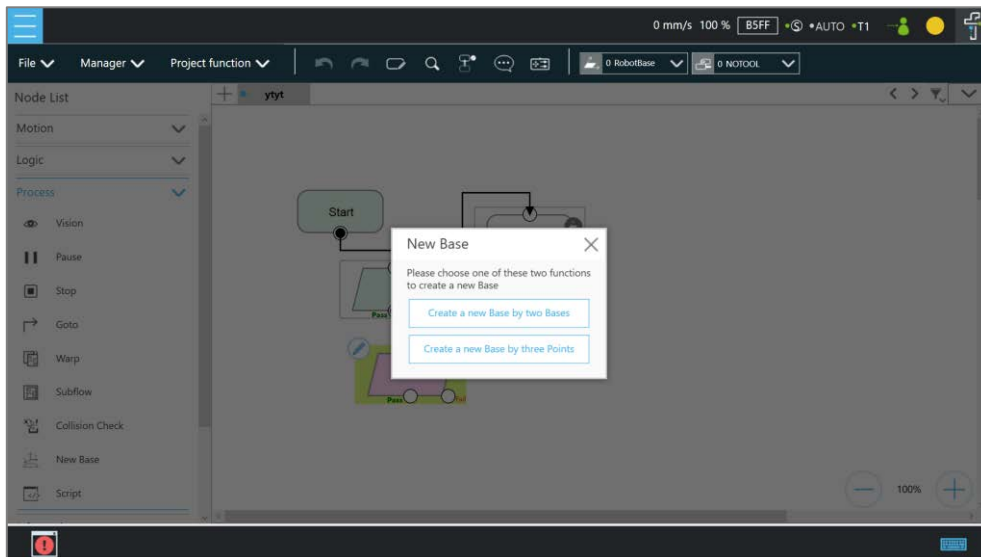

Figure 7 - 3: New Base Node

### 1.34.1 Create a New Base by Multiple Bases

#### 1.34.1.1 Create a New Base with Two Vision Bases

This function is to create a new **Base** with two **Vision Bases**. While the project is running, if the relative distance between the two updated **Vision Bases** fall within the tolerance range set by users, it is possible to create a new **Base**, or the node will go to the path of fail.

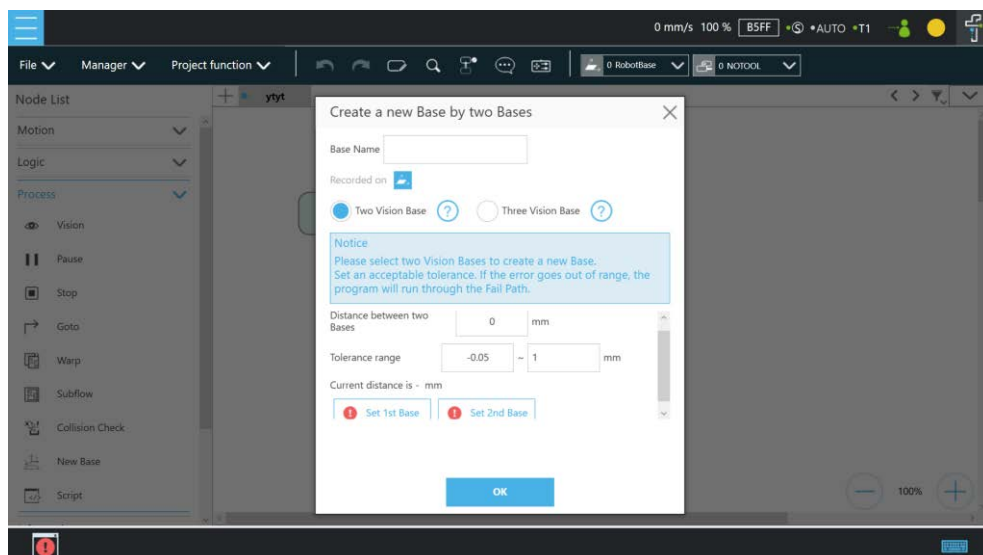

Figure 7 - 4: Create a New Base with Two Vision Bases

#### 1.34.1.2 Create a New Base with Three Vision Bases

This function is to create a new **Base** with three **Vision Bases**, and use the position of the first **Vision Base** as the initial position, the second **Vision Base** to set the direction the x

axis, and the third **Vision Base** to set the fiducial orientation. Since this function only uses the position to create the new **Base**, it cannot be affected by the error of the visual recognition angle, and it is applicable to situations where the angle is required to be highly stable. While the project is running, users can set the tolerance ranges of the initial position to the second **Vision Base** and the third **Vision Base**. If the calculated distance falls within the tolerance range set by users, a new **Base** will be created, or the node will go to the path of fail.

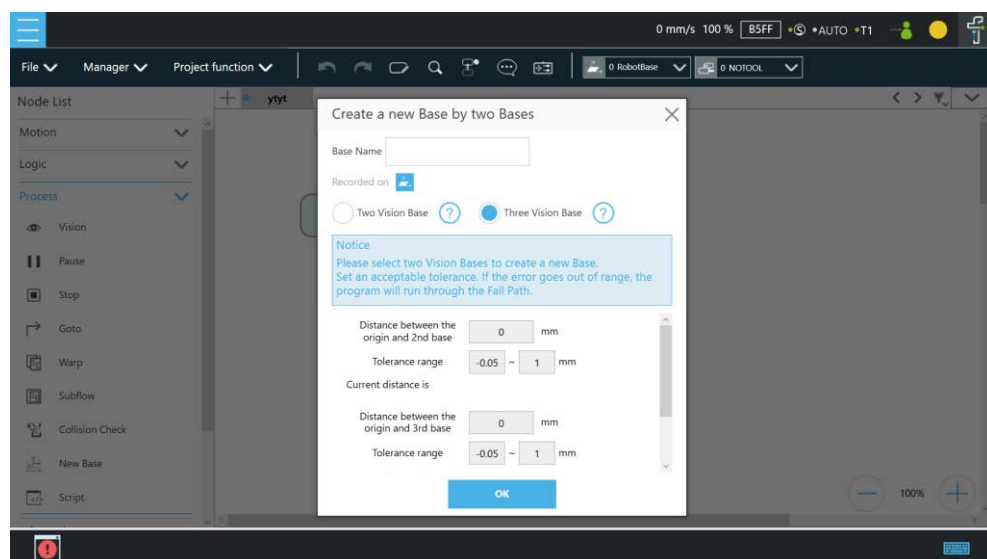

Figure 7 - 5: Create a New Base with Three Vision Bases

### 1.34.2 Create a New Base with Three Points

This function is to create a new **Base** with the three points such as the points on the **Vision Bases**, the **Dynamic Points**, and the points in general to be used together. The two common situations create a new **Base** with three points on the **Vision Base** and create a new **Base** with three **Dynamic Points**, are described below.

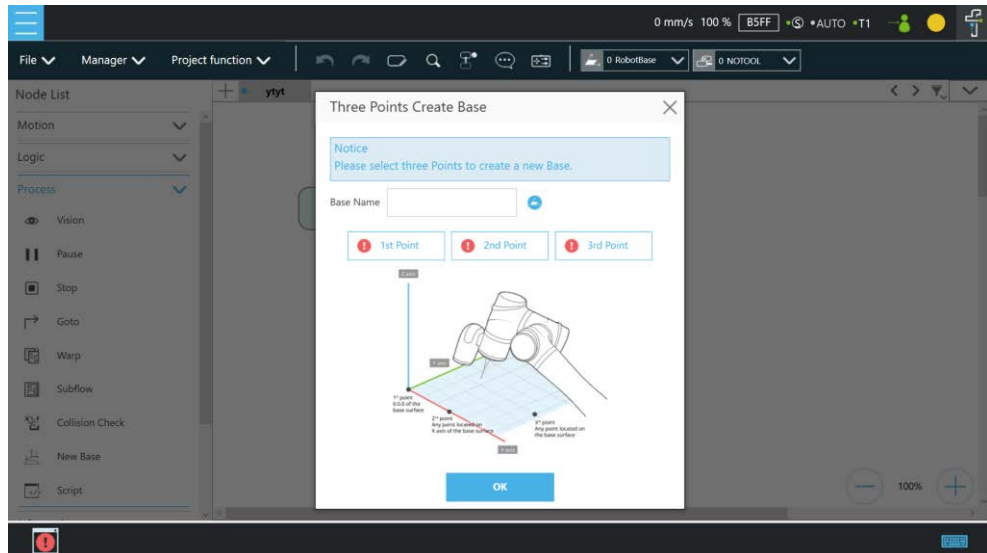

Figure 7 - 6: Create a New Base with Three Points

#### 1.34.2.1 Create a New Base with Three Points on the Vision Base

In situations where it is not possible to create a new **Base** by visual recognitions, users can create a new **Base** with the points recorded on the **Vision Bases**. By using the **New Base** node, it is possible to launch the **Point Manager** and use the points in the **Point Manager**. The first selected point sets the initial position of the **Base**, the second selected point sets the direction the x axis, and the third selected point sets the fiducial orientation. As illustrated below, P1, P2, and P3 are applied to create a new **Base**. Since the points are recorded on the **Vision Base**, the newly created **Base** changes as the **Vision Base** changes.

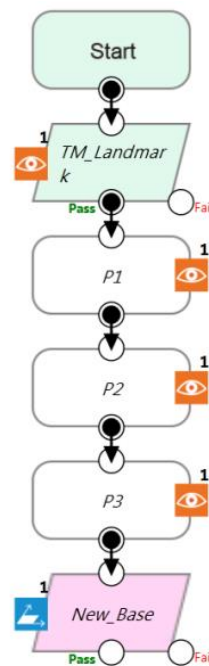

Figure 7 - 7: Create a New Base with Three Points on the Vision Base

#### 1.34.2.2 Create a New Base with Three Dynamic Points



Rather than using points on the Vision Bases, this function uses the Dynamic Points built by the Touch Stop nodes to create a new base. In situations where it is not possible to create a new Base by visual recognitions, users can create a new Base with the Dynamic Points built by three Touch Stops. The first Touch Stop sets the initial position of the Base, the second Touch Stop sets the direction the x axis, and the third Touch Stop sets the fiducial orientation.

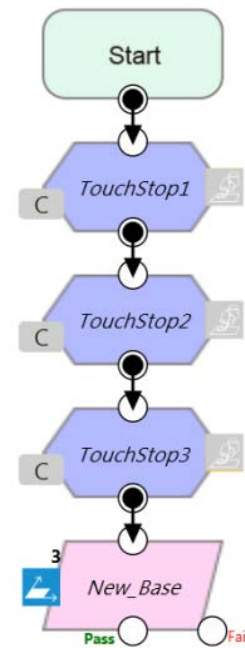

Figure 7 - 8: Create a New Base with Three Dynamic Points

## Create the TCP

### 1.35 Overview

The **TCP** (Tool Center Point) is the reference point for tool interaction with the workpiece. The **TCP** includes six parameters: X Coordinate, Y Coordinate, Z Coordinate, Rx Coordinate, Ry Coordinate, and Rz Coordinate. The **TCP** is attached to the end of the robot, and is referenced from the center coordinates of the flange.

On the robot, apart from the position and orientation reference values of the six elements, the tool weights and the inertia values can also be input to compensate the performance during operation to avoid misreading the effect of the tool on the robot as an external force. The **Tool Settings** can be accessed from the **Configuration** page.

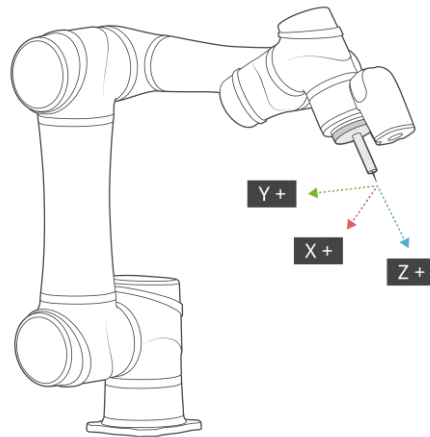

Figure 8 - 1: TCP Definition



#### **WARNING:**

When setting the TCPs, it is necessary to consider these TCPs within the range of safety tool points. Users must properly configure the safety tool points to cover all the possible TCPs used. Users must take responsibility and include the TCPs within the range of safety tool points. Failure to perform a proper risk assessment or the safety configuration or failure to comply with the safety manuals may increase the risk of injury or death.

For details of the monitored safety end-points by the different limit functions, refer to the respective system version of the *Safety Manual*.

### 1.36 Tool Settings

This section describes how to get parameters of **TCP** from **Teach TCP Parameters**, **Set Tool Parameters**, or clicking .

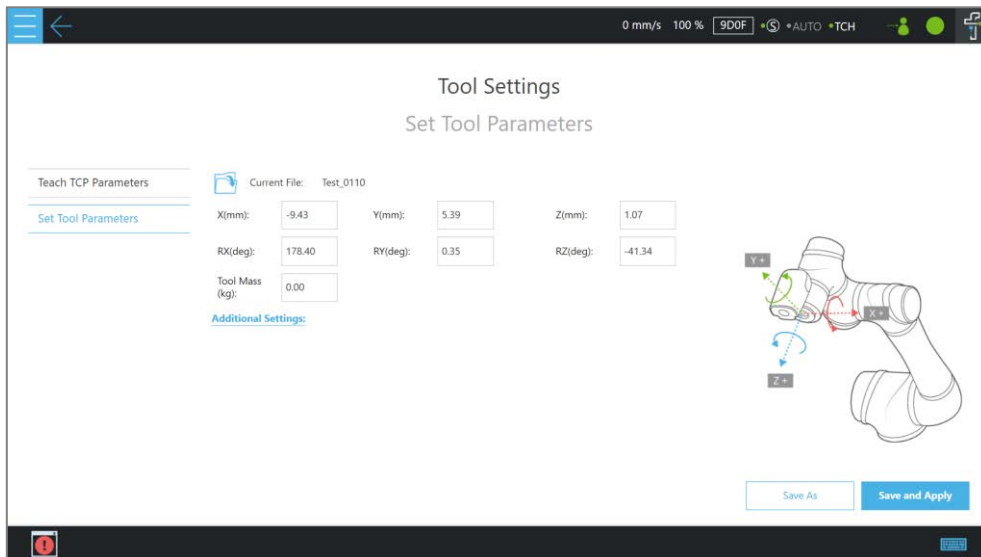

Figure 8 - 2: Tool Settings

### 1.36.1 Create Parameters of TCP with Hand Guidance Teaching

The principle of creating the **TCP** by teaching is to teach the robot to reach the same point in the space through a different posture, to calculate the position of **TCP** relative to the robot end flange automatically. The **Calibration Pin Set** sold by the Corporation or a custom-made calibration tool can be used to calibrate the fixed calibration point in the space during the teaching process. The number of calibrations varies depending on users' operation method and accuracy requirements. The number of teachings on the **TCP** is at least 4 times.

Follow steps below to create a **TCP** by teaching:

1. Set the times of calibration and the mass of tools

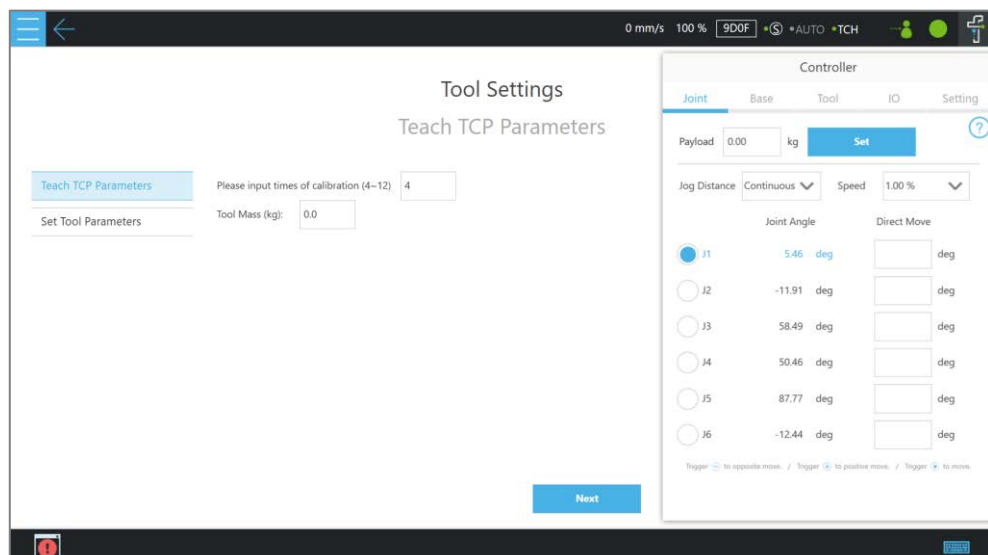

Figure 8 - 3: Set the Times of Calibration

The position of the **TCP** is clearly marked on the tool. In this example, the tool is a **Calibration Pin Set**, and the **TCP** is located at the tip of the needle.

2. Fix the **Calibration Needle** on a solid surface.

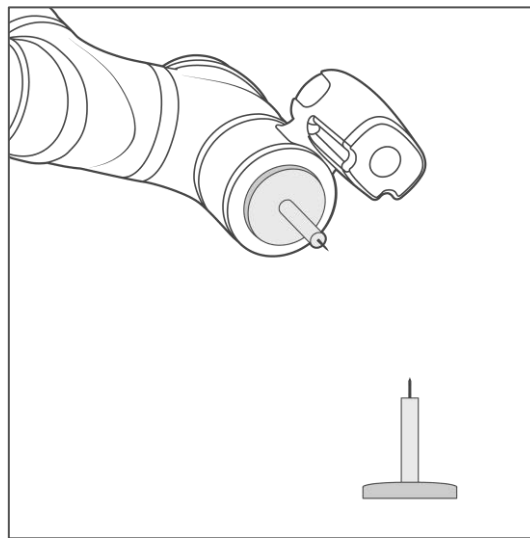

Figure 8 - 4: Teaching Screen

3. Align the end of tool to the calibration point by teaching, and follow by clicking the record on the screen.

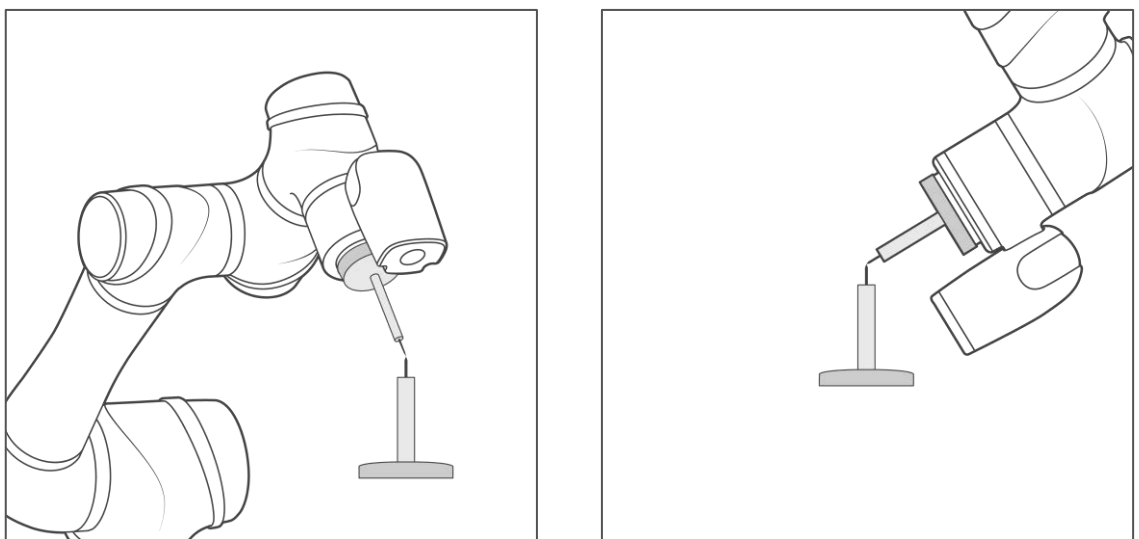

Figure 8 - 5: The Robot Posture Needs to Change during Teaching (1/2)

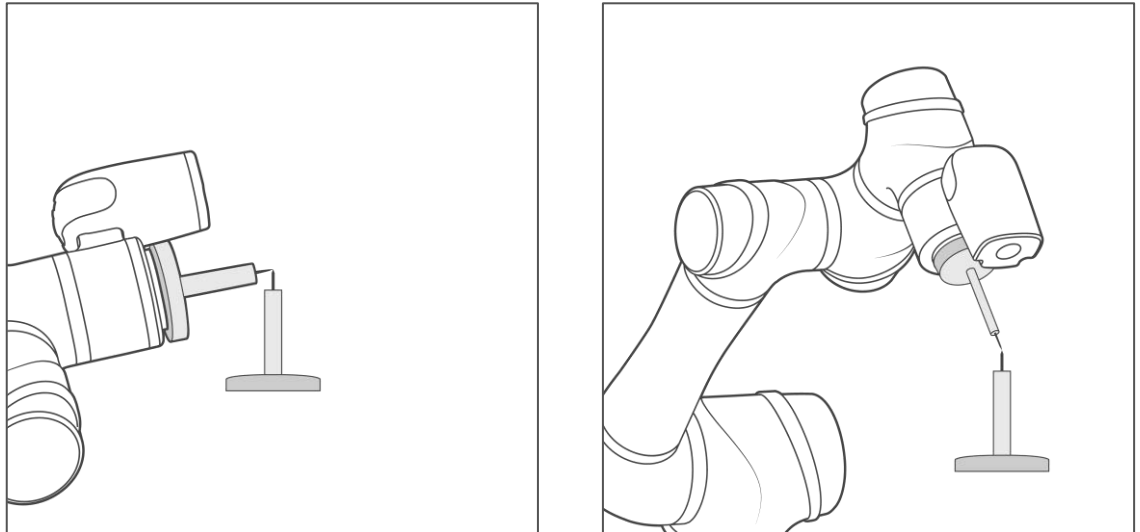

Figure 8 - 6: The Robot Posture Needs to Change during Teaching (2/2)

4. Repeat this action until completed and the **TCP** numerical results and error values are displayed. After confirming that there is no mistake, input the tool name to save the file, and set it as the current tool for the robot.
5. After teaching is completed, the positioning result will be displayed.

Note

**NOTE:**

It is recommended to calibrate this value equal to or less than 0.3 to ensure accuracy.

IMPORTANT

**IMPORTANT:**

In addition to users' human errors and the number of calibrations, the error of establishing a **TCP** by teaching is also related to the selected teaching poses. The more joints that you change, and the more you change each one, the better. Between each teaching point, rotate each joint, to achieve the best calibration result.

Note

**NOTE:**

When using the **Calibration Pin Set** to teach **TCP**, the controller can be used to fine-tune the moving robot. Between each teaching point, it is still necessary to ensure that 1 to 6 joints are rotated.

6. The calibration result can be saved for future use.

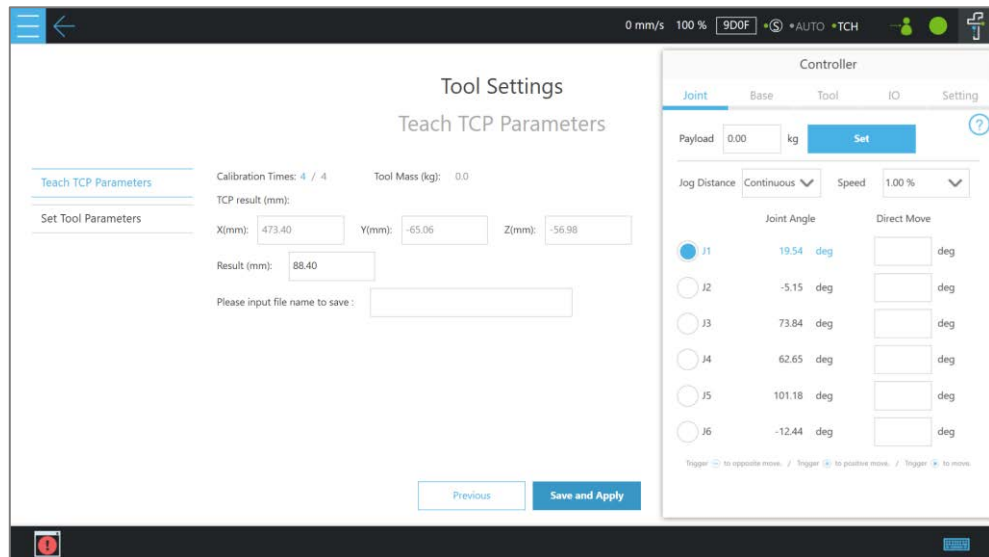





Figure 8 - 7: Save Teaching Result

### 1.36.2 Create Tool Center Point by Input Parameters

If users know the description of tool frame relative to the robot end flange frame, the parameters can be input manually. For **Principal Moments of Inertia** and **Mass center frame with principle axes w.r.t the robot end flange frame**, click **Additional Settings** to expand the input fields. After the input is completed, click **Save as** to create a new tool setting. To modify the tool parameters, click  to select the item to be modified from the list, and after the modification is completed, click **Save and Apply** at bottom right to save the changes and set these parameters as the current tool setting applied to the robot. Users can also click  to select the other item applying to the robot, or click  after the item to delete the corresponding tool parameters.

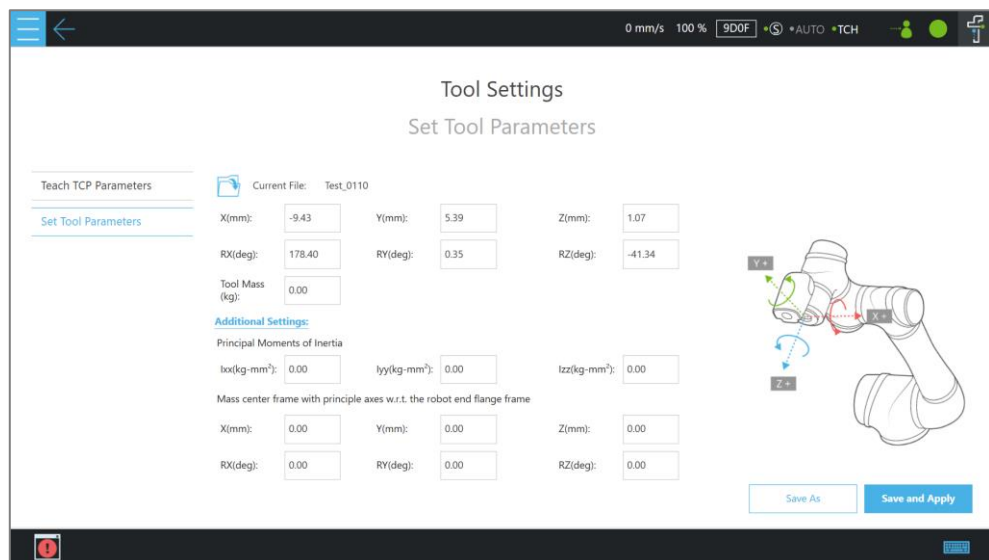
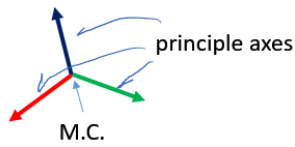

Figure 8 - 8: Set Tool Parameters

① The robot end flange frame  
This frame is defined by TECHMAN.

② The tool mass center frame with its principle axes



Users can obtain information about the tool mass center frame without difficulty if designed the tool with CAD software.

③ The tool frame  
Users should define the tool frame according to the requirement of a specific task. This frame includes the so-called TCP and its associated orientations.

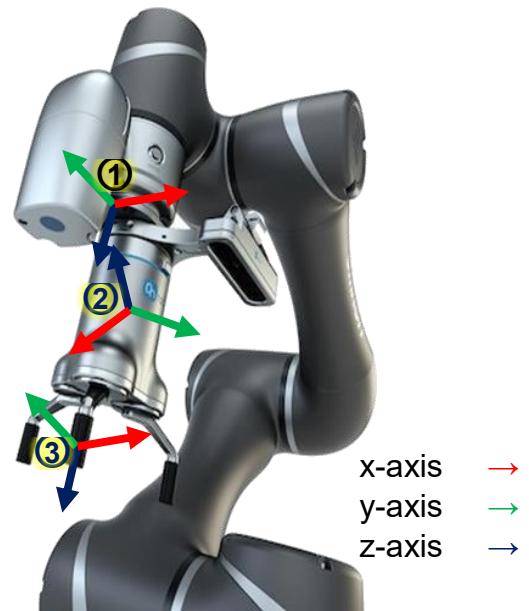
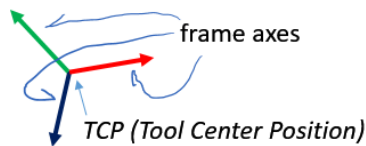

For tools with a large mass, a TCP offset, or both, users can click **Additional Settings** to open and manually input extra Tool settings. The robot will compensate more appropriately for the tool's moment of inertia and mass center frame during operation.

## Motion Programming

### 1.37 Overview

This chapter will introduce the robot's commonly used motion nodes, describe its basic features and motion modes, and help users understand blending.

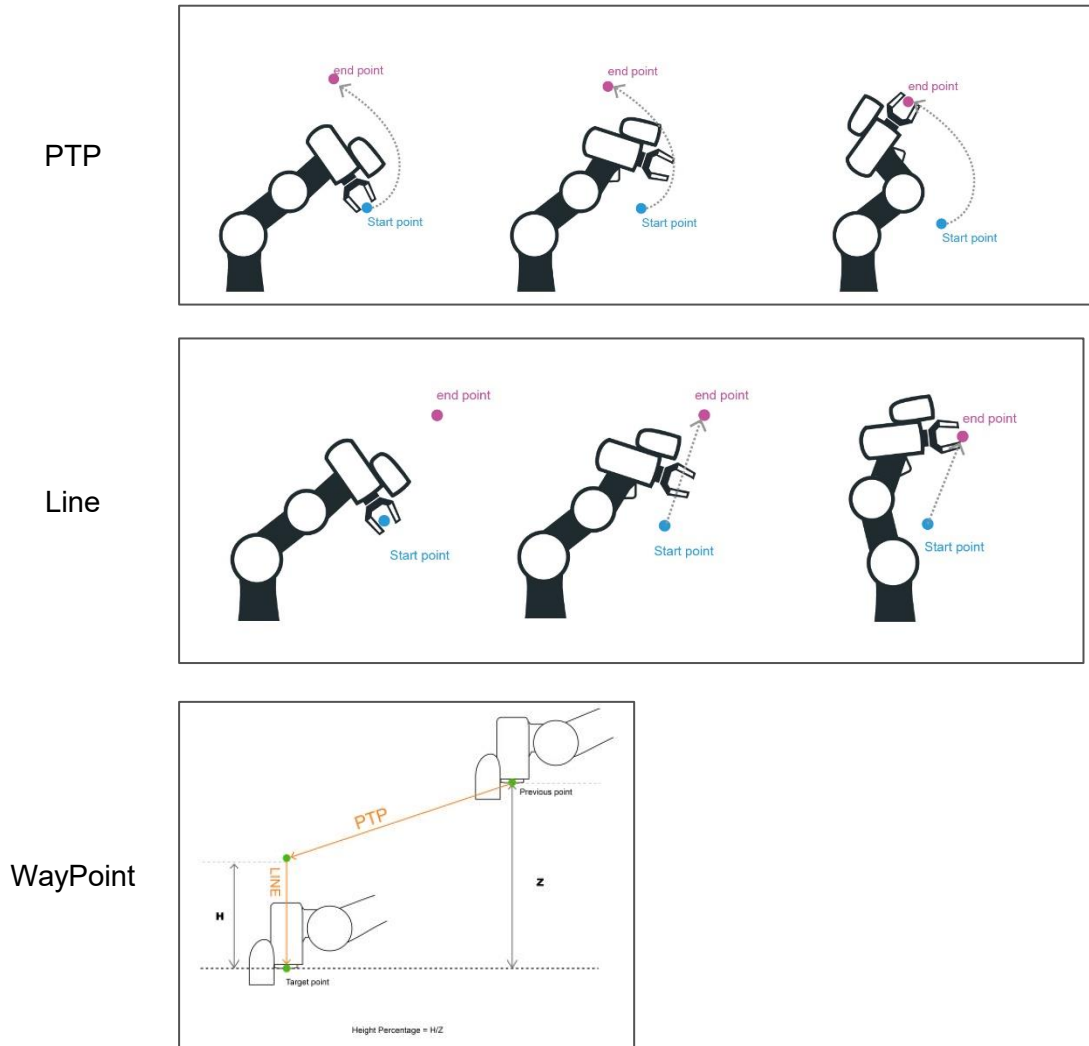

Figure 9 - 1: TM Robot Motion Modes

- **PTP (Point to Point):**  
The robot moves to the target point along the closest path of the joint angle space
- **Line:**  
The tool moves in a straight line at the specified speed

#### Note

#### NOTE:

User can set PTP and Line speed via variables. However, the motion of the point node comes with the issues of mixing trajectories because the point node must calculate the motion commands in advance. Accordingly, if the speed variable of the point node is



changed in other threads, the speed of the robot will not be the current value of the variable. To ensure the correctness of the speed variable in the motion command with the point node, users need to add a Wait For node or update the speed variable ahead of the point node in the same flow.

- **WayPoint:**

The tool performs two-stage path movement at the set percentage of Z-axis height or distance, and it is often used for pick and place applications.



**NOTE:**

To maintain the smoothness and the continuity of the motion, the flow in process calculates and sets each value in the nodes with the logic and the sequence of the programming. The calculation is made much earlier than the time to actually perform the motion. If using variables as the parameters in the motion nodes, users must insert other nodes such as the Set nodes, the Network nodes, or the Listen nodes before the motion node to assign the correct values to the variables.

The following will introduce motion programming through a flow project.

## 1.38 Point to Point (PTP)

### 1.38.1 PTP is the Fastest Way to Move

The PTP mode determines the robot's motion by calculating the angular variation of each axis, and is not limited by the singularity point. If not limited to the robot's motion path, such as the initial point of the project, it is favored to select PTP to ensure no problems will occur when moving this point with various poses.



**IMPORTANT:**

Singular points are described in the *Safety Manual*.

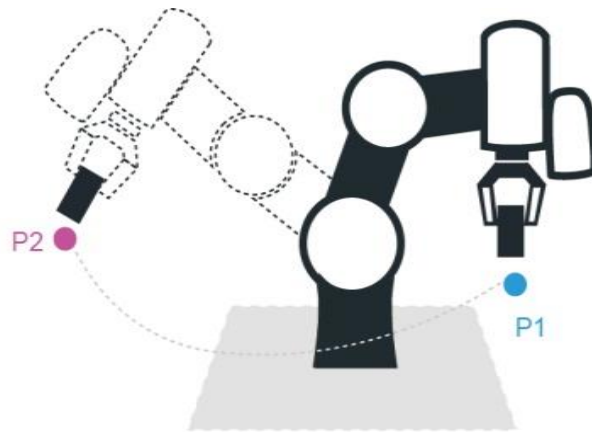

Figure 9 - 2: PTP Motion

### 1.38.2 Speed of PTP Motion

The PTP speed is based on the motion joint that takes the longest time. The PTP mode may cause the TCP to exceed speed limit, especially when the robot length is longer, and should be avoided. In PTP speed setting, users can set speed percentage and time to top speed.

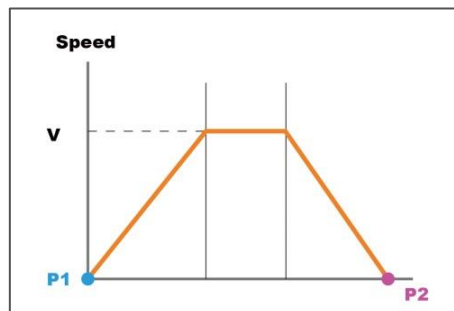

Figure 9 - 3: Speed of PTP Motion

### 1.38.3 Plan for PTP Movement

In the example, working with the TCP T4 to move the workpiece from P1 to P2 does not need to limit the robot movement path, using the PTP setting at the P2 Point node, after the robot reaches P1. In this case after the arm reaches P1, the fastest movement path will be planned to move to P2.

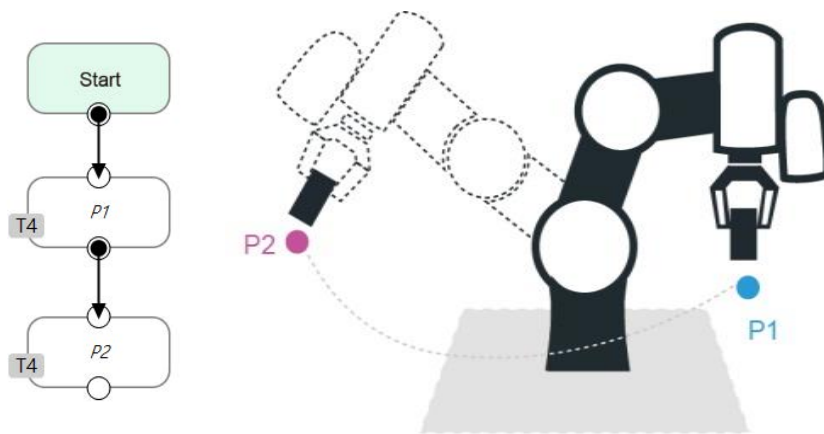

Figure 9 - 4: PTP Application Examples

### 1.38.4 PTP Smart Pose Choosing

By default, in PTP motion, the system will choose the configuration determined from the recorded robot pose and move to the target point. This feature has the system ignore the configuration from recorded robot pose and choose the most efficient configuration on the way to the goal. This feature is applicable to **Vision**, **Point**, **F-Point**, and **Path**. However, it is not applicable to **Move**.

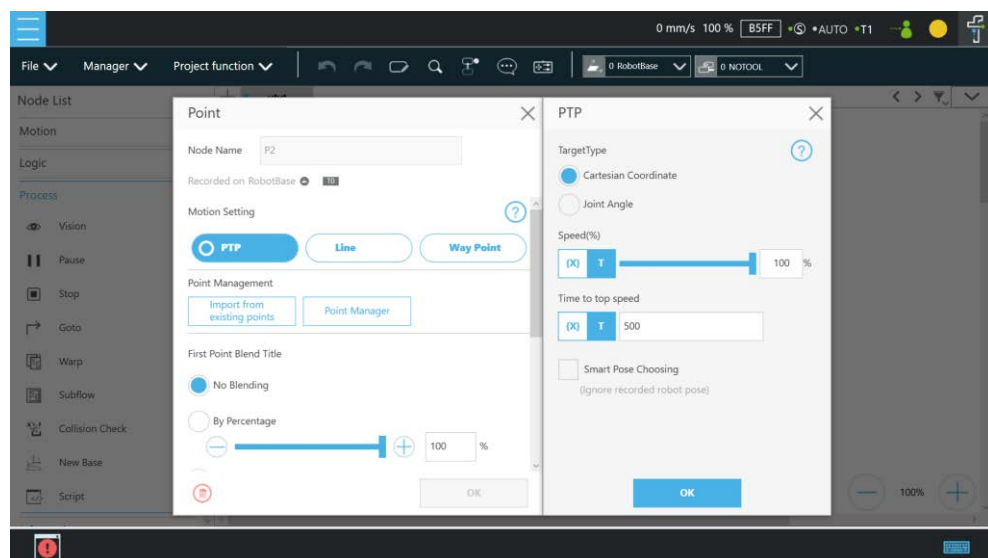

Figure 9 - 5: PTP Smart Pose Choosing

## 1.39 Line

### 1.39.1 Line Moves the Shortest Distance

A straight line is the shortest distance between two points. The Line mode specifies that the path between the two points is planned as a straight line.

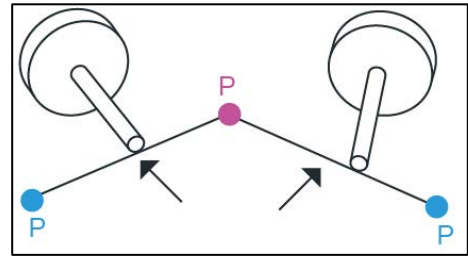

Figure 9 - 6: Line Motion

### 1.39.2 Speed of Line Motion

Line mode may cause joint speeding. Try to avoid speeding close to a singularity point, or make the posture large-angle movements over a short distance.

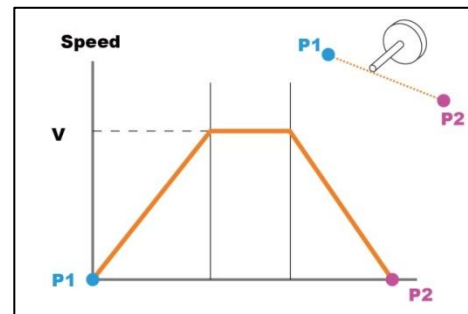

Figure 9 - 7: Speed of Line

**Percentage of Typical Speed** and absolute speed value can be set in Line speed setting. The available range of **ABS Speed** is from 0 to 4500 mm/s, and the available **ABS Time to top speed** is from 150 to 9999 ms. Check the box next to **Link to project speed** to align the speed with the project speed. Once selected **ABS**, users can check **Constant TCP speed** to ensure TCP speed remains constant at the **ABS Speed**.

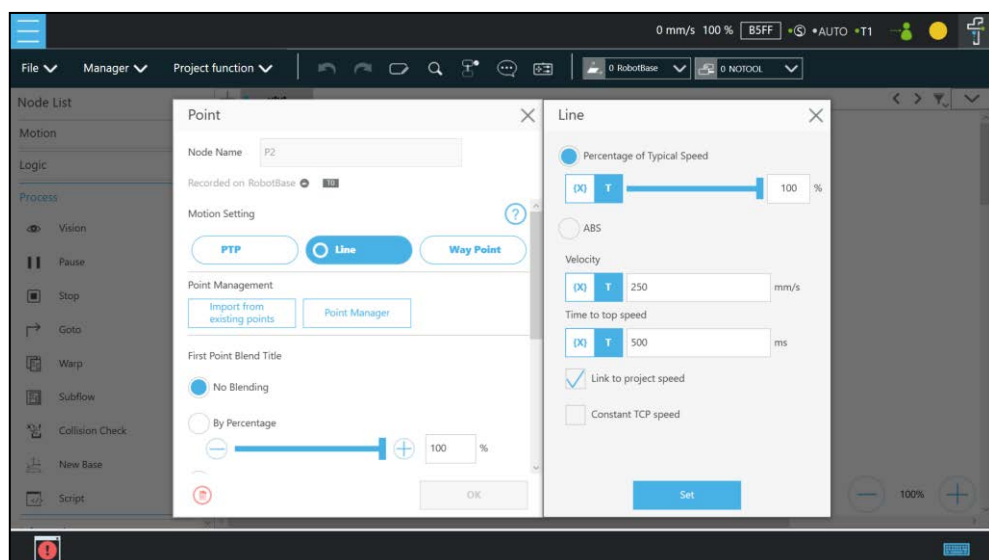

Figure 9 - 8: Link to Project Speed

The **typical speed** is the suggested maximum speed of a regular application, and is the linear speed of the center of the tool flange of the robot, used in the specified cycles defined in these specifications:

- Repeatability
- Maximum Payload

If users want to set higher speed, use the **ABS** setting in the node. The maximum speed of the robot is highly dependent on the pose of the robot and joint motion. Refer to the maximum joint speed in the specification for the composition of velocities of the tool end.

### 1.39.3 Plan for Line Movement

The figure below explains that this project sets two points P1, P2, and tool T22. Using the Line setting at the P2 **Point** node, after the arm reaches P1, it will move to P2 with Line path.

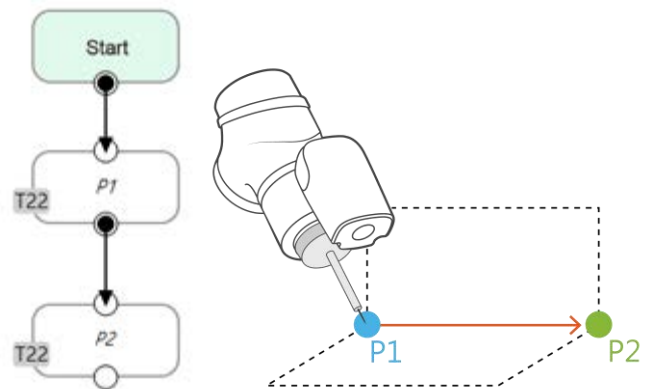

Figure 9 - 9: Line Application Example



#### **IMPORTANT:**

ABS (Absolute) speed setting, including **Point**, **Path**, **Move**, and nodes can be used when the speed is linked with **Project Speed**. When not clicked, the arm motion maintains the ABS set speed. The warning window will pop up when the speed setting exceeds 250 mm/s, and check automatically, display "**Speed exceeds 250 mm/s, needs to be linked with Project Speed**".

## 1.40 Two-Steps Motion (WayPoint)

### 1.40.1 WayPoint

The two-step movement will maintain a part of Z-axis displacement on the point **Base**. When the 1st step XY axis is aligned and in position, the 2nd step will move toward the Z-axis. This is often used in pick-and-place applications. To plan the motion from the 1st step to the 2nd step, users can choose either **PTP to Line** or **Line to Line** motion.

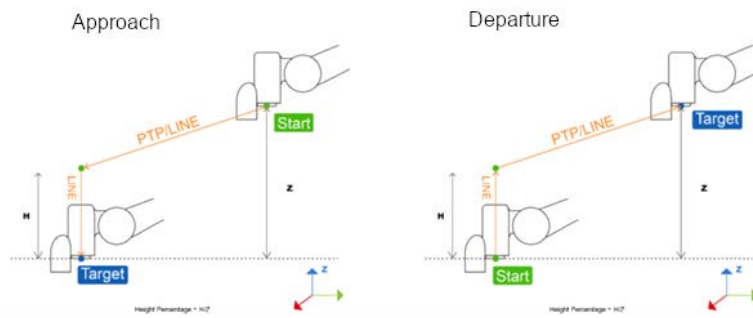

Figure 9 - 10: WayPoint Motion Status

The movement is taken as approaching motions with moving sequence from the 1st step to the 2nd step when the target point direction is on the direction of +Z in the tool coordinate, and the movement is taken as leaving motions with moving sequence from the 2nd step to the 1st step when target point direction is on the direction of -Z in the tool coordinate.

The approach and departure of the WayPoint motion is set by the system automatically with the following criteria:

- For approaching motions, users have to set the target point on the same direction as the Z-axis of the robot's tool coordinate with the starting point.
- For departing motions, users have to set the target point on the opposite direction from the Z-axis of the robot's tool coordinate with the starting point.



**IMPORTANT:**

Once the z-axis direction of the tool coordinate is almost perpendicular to the z-axis direction of the target coordinate, any slight movement of the robot's posture will change both directions into the same or the opposite and influence the WayPoint motion to approach or depart. Therefore, to keep from generating the scenarios of the z-axis direction of the tool coordinate virtually perpendicular to the z-axis direction of the target coordinate, using teach points in the application scheme is recommended. If there is no way to ensure the conditions above are satisfied, replacing the **WayPoint** motion mode of the node with **PTP + Line** or **Line + Line** is recommended to avoid the generations of the unexpected blending in the movement.

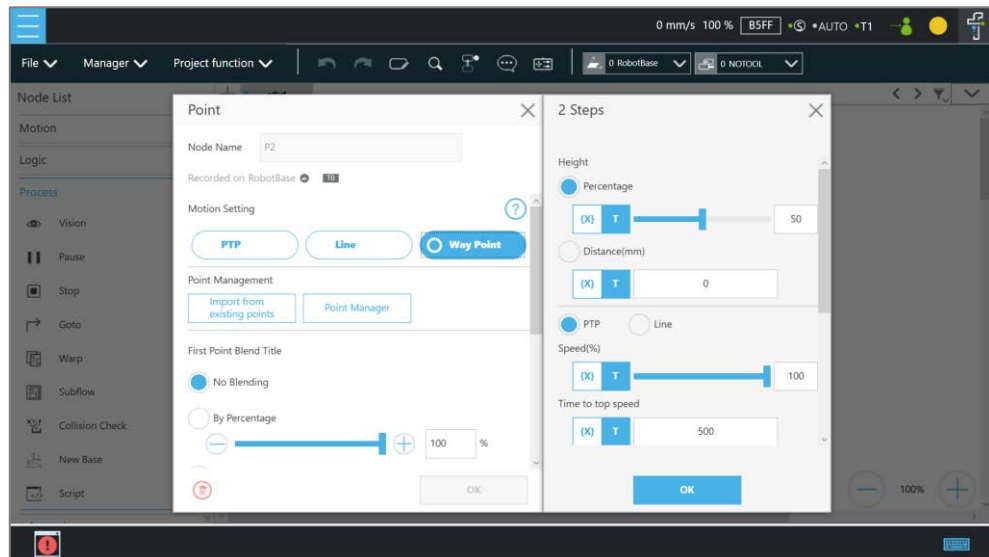

Figure 9 - 11: WayPoint Setting

Users can set the **Percentage** value with the slider or in respective field and **Distance** in another to maintain height in mm. Also, users can use the **{x}** button to set the value with a variable. If the variable for percentage is larger than 100, the system uses 100. If it is smaller than 0, it equals to 0. The data type of the variable must be integer.

#### 1.40.2 Plan for WayPoint Movement

The following figure is an example to illustrate that if there are obstacles around the workpiece to be picked, extra care is needed to avoid a collision. This project creates a point P1, sets the WayPoint motion mode, retains a Z axis height before reaching P1 point, and then goes downward to pick the workpiece, to prevent a collision.

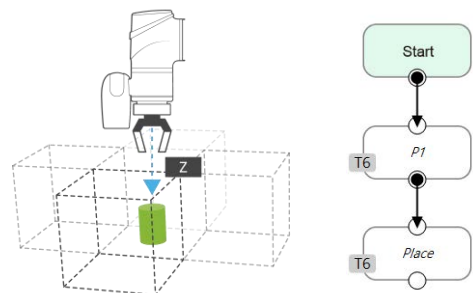

Figure 9 - 12: WayPoint Application Examples

### 1.41 Blending

#### 1.41.1 Blending in Movement

In the process of planning a trajectory, the robot will not exactly pass through each programmed point, which has the advantages of reducing the number of robotic brakes and reducing wear and shortening the cycle time. As shown in

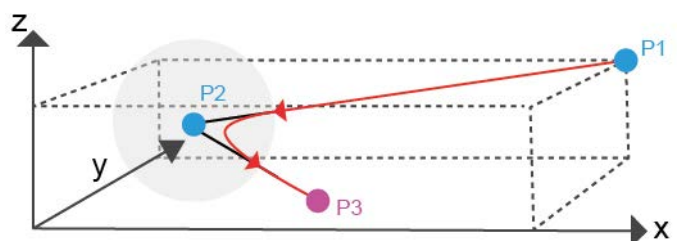

Figure 9 - 13: Blending in Space

the figure below, a movement from P1 to P3 is planned, and P2 does not need to be exactly in the path. In this case, **Blending** can be set at P2 point.

### 1.41.2 Blending Speed Change Chart

The cycle time can be shortened by Blending as shown in the figure.

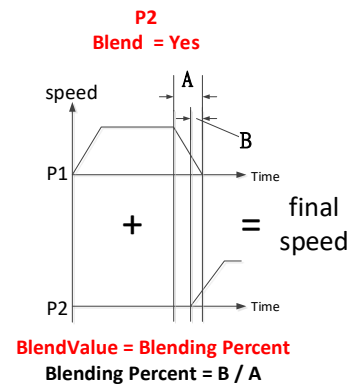

Figure 9 - 14: Blending Speed Change Chart

### 1.41.3 Set the Blending Percentage

Users can click By Percentage to set the blending percentage in Line, PTP, and Circle motion modes.

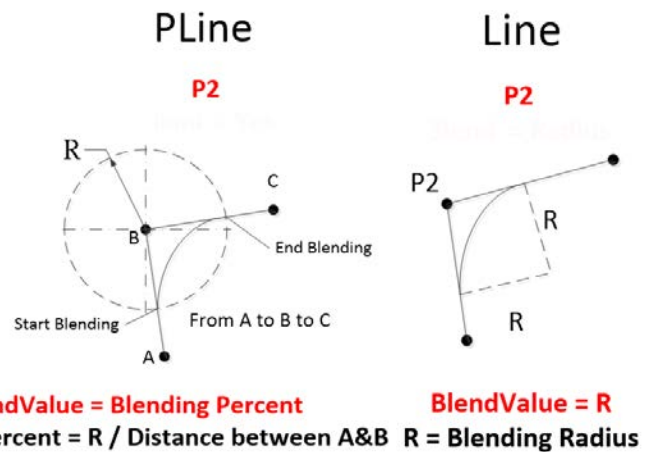

Figure 9 - 15: Set the Blending Percentage or Set the Blending by Radius



**IMPORTANT:**

When using Blending Percentage, pausing the robot motion or changing the speed during the trajectory blending process will affect the trajectory blending path.



### 1.41.4 Set the Blending by Radius

In Line mode, users can click **By Radius** to set the **Blending** by radius. Line is a commonly used motion mode in Point Nodes. For details, refer to the sections with corresponding titles of this manual.



**IMPORTANT:**

As shown in the table below, blending can improve the smooth running of robot, but when the **Blending** radius has been set by Line motion, blending with Circle and PTP cannot be used.

P1 \ P2	PLine	Line		PTP	Waypoint	Circle	Pallet	Path
		%	Radius					
PLine	○							
Line	%	○	○	○	×	○	○	○
	Radius	○	○	×	×	×	×	○
PTP		○	×	○	×	○	○	○
Waypoint		○	○	○	×	○	○	○
Circle		○	○	○	×	○	○	○
Pallet		○	○	○	×	○	-	○
Path		×	×	×	×	×	×	×

Table 11: Valid Blending Setting (Moving from P1 to P2)

Notice:

- Blending is available in the insertion of IF nodes and unavailable in the insertion of the Wait For node insertion as well as the connection of the Listen Node.
- Set DO while moving is unavailable to move blending and go back to the previous subflow.

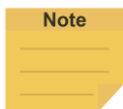

**NOTE:**

Once the calculated trajectory is less than 10 mm, and the angle between the two lines is less than 90°, the system refers to it as a sharp turn and voids the radius blending between the two lines.

### 1.42 Motion Nodes

Payloads of motion nodes support variables as inputs. The available data types of the variables include integer, float, and double. This feature is applicable to **Point, Pallet, Move, Circle, Path, F-Point, Compliance, Touch Stop, and Force Control.**

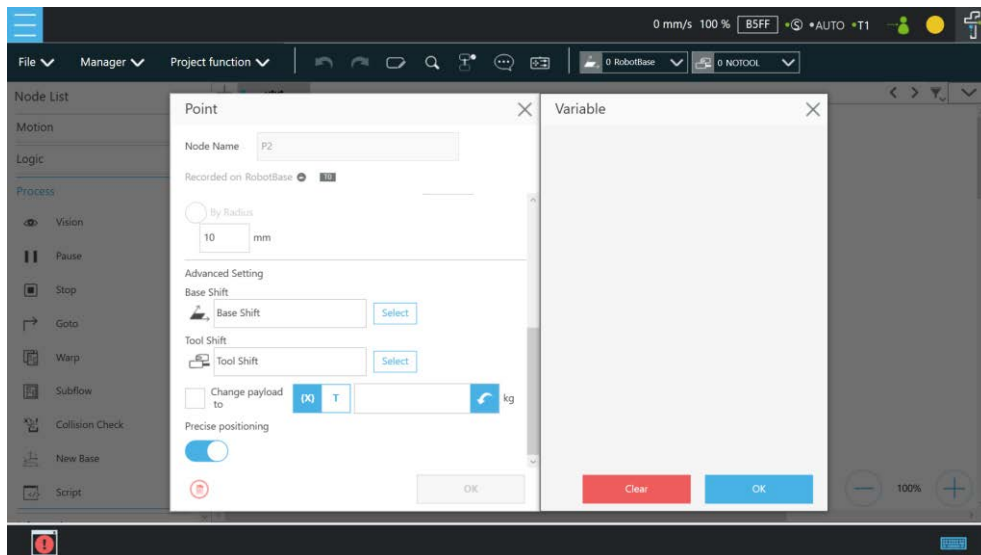

Figure 9 - 16: Motion Nodes Support Variable as the Inputs

Also, users can adjust the speed, the payload, the blending settings, and the precise positioning option of motion nodes by selecting nodes to adjust in advance and clicking on the respective buttons in the **Edit Block** menu to adjust in a batch. This feature is applicable to **Vision** (PTP, Line), **Point** (PTP, Line, Waypoint), **Pallet** (PTP, Line, Waypoint), **Move** (PTP, Line, Joint), **Circle** (Line), **F-Point** (PTP, Line, Waypoint), and **Path** (PTP, Line, Pline, %); however, it is not applicable to **Touch Stop**, **Compliance**, **Smart Insert**.

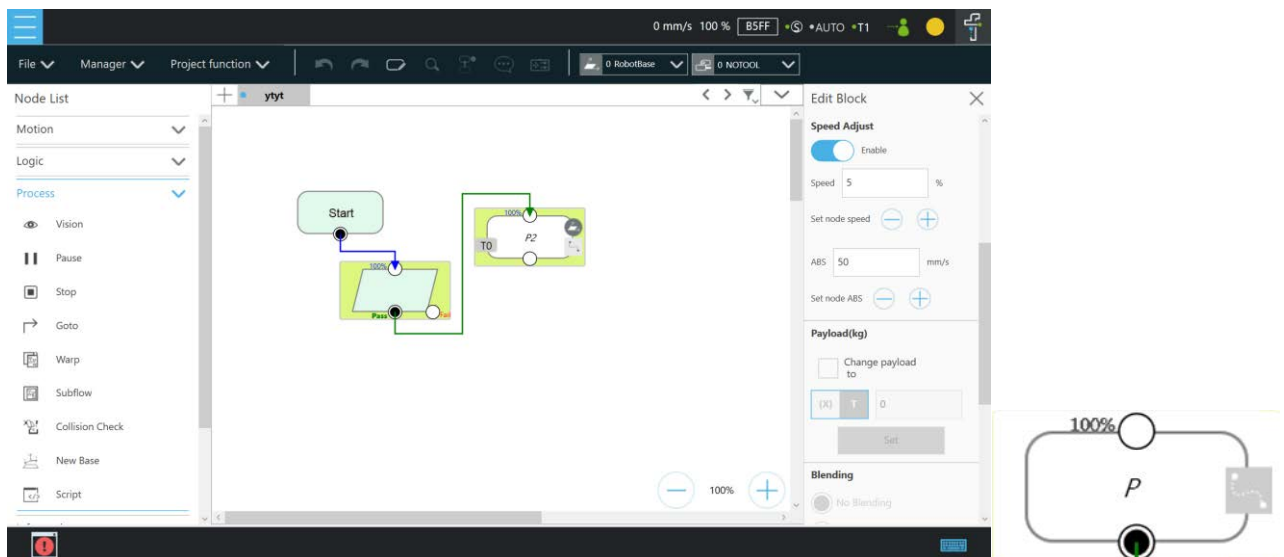







Figure 9 - 17: Speed Adjust and Speed Indication on the Node

#### Note

#### NOTE:

When using nodes such as Point, F-Point, or Move, at the bottom left of the node setting, users can click  to save the current settings and the default values as templates in the project. The default naming of the template goes by node type + \_Temp + N up to 32 characters. Templates cannot go with duplicate names. Users can save up to 4 templates in one single type of node. Templates will not keep the items such as recorded bases, node names, fine-tune values (in F-Point node), or moving settings (in Move node) along. After saving the template, the associated node adds to the node list. Users can click  to select a template to apply to the current node. If a node contains parameters not from the project, there will be a warning message and no template saving.

### 1.42.1 Point Node

Users can see the motion type of the point node at the right of the node as shown. Icons for the motion types are  for PTP,  for Line, and  for WayPoint.

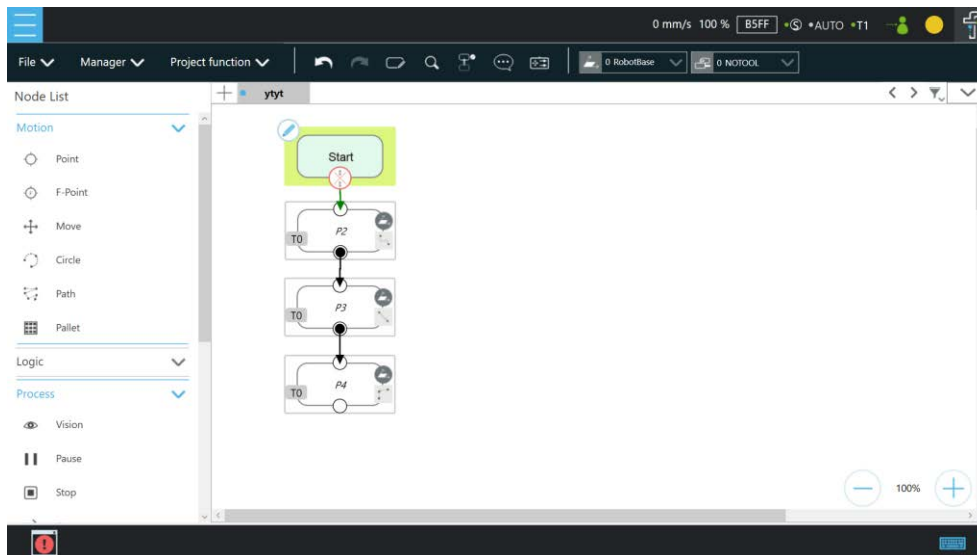

Figure 9 - 18: Point Node

#### 1.42.1.1 Generation Method of Point node

TMflow currently has two methods to generate a Point. The point generated will be entered on the list of Point Manager.

1. Drag the **Point** Node from the node list to the **Project Editing Area** to add the new point.
2. Click **POINT** at the End Module to add the point.

#### 1.42.1.2 Point Node Setting

The Point Node can be set to motion mode, **Blending**, **Base Shift** and **Tool Shift**. The robot will determine the mode of moving to this point according to the above setting.

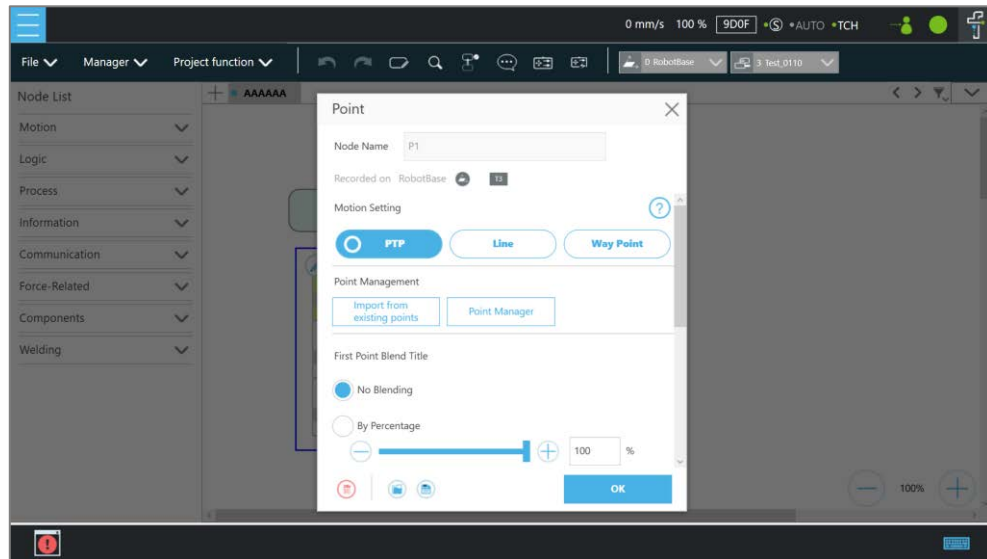

Figure 9 - 19: Point Node Setting

- **Motion mode setting:** Set motion type. If selected **PTP**, users can set the **Target Type** to **Cartesian Coordinate** for the robot moving to the target point based on its Cartesian coordinates or **Joint Angle** based on its joint angles.
- **Point Management:** Can choose from an existing point or open the **Point Manager**
- **Blending setting:** Set blending type
- **Advanced settings:** Base shifting / Tool shifting
- **Payload:** Load setting of robot end
- **Precise positioning:** Whether moves to the point precisely



**IMPORTANT:**

If you have not selected **Precise Positioning**, the robot arm will not stop at the **Precision Point** but instead directly move on to running the next command. If you select **Precise Positioning**, the robot arm will wait until motion along all axes has stabilized at the **Precision Point** before moving on to running the next command.

### 1.42.2 F-Point Node

This Node can perform fine tuning of X, Y, Z Axis  $\pm 10\text{mm}$  and Rx, Ry, Rz  $\pm 5^\circ$  at the existing point. During the project execution, the F-Point variable can also be corrected in the **View** page. In addition, since inputting variable to fine tuning point is not a safe action when the project is running, the login password protection is designed on the interface. Set and use the settings appropriately.

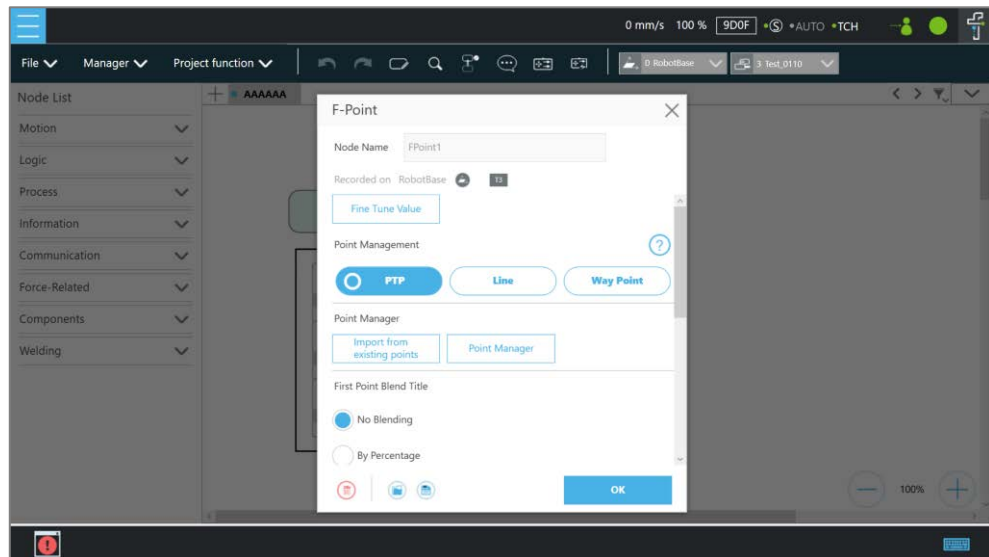

Figure 9 - 20: F-Point Node

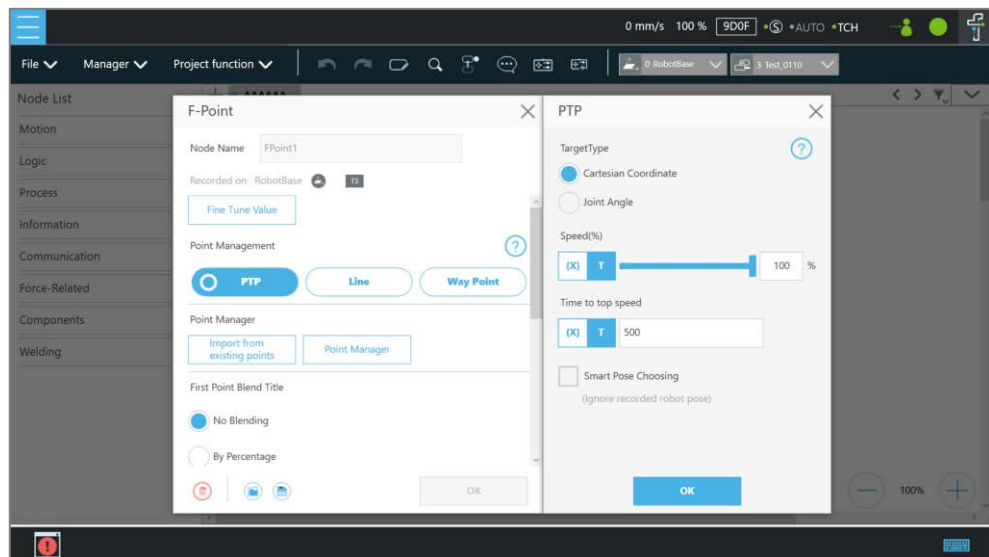

Figure 9 - 21: F-Point Node Setting



**IMPORTANT:**

In a single project, the number of F-Points is limited to 20.

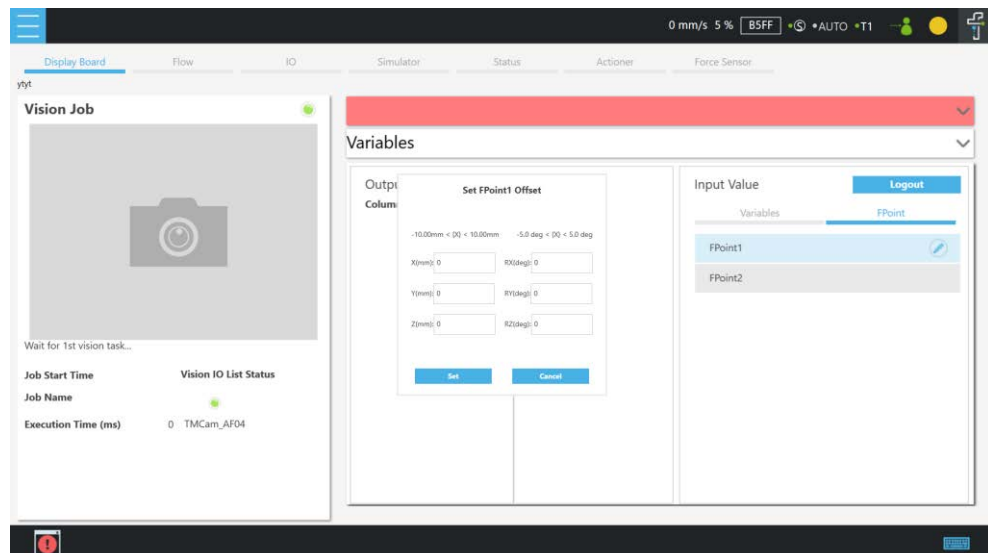

Figure 9 - 22: Adjust F-Point Parameter during Project Running

### 1.42.3 Move Node

In this node, users can set values from the Base X, Y, Z, RX, RY, RZ or six-axis angles J1~J6 to determine robot movement distance/angle, and then perform relative movement from current position.

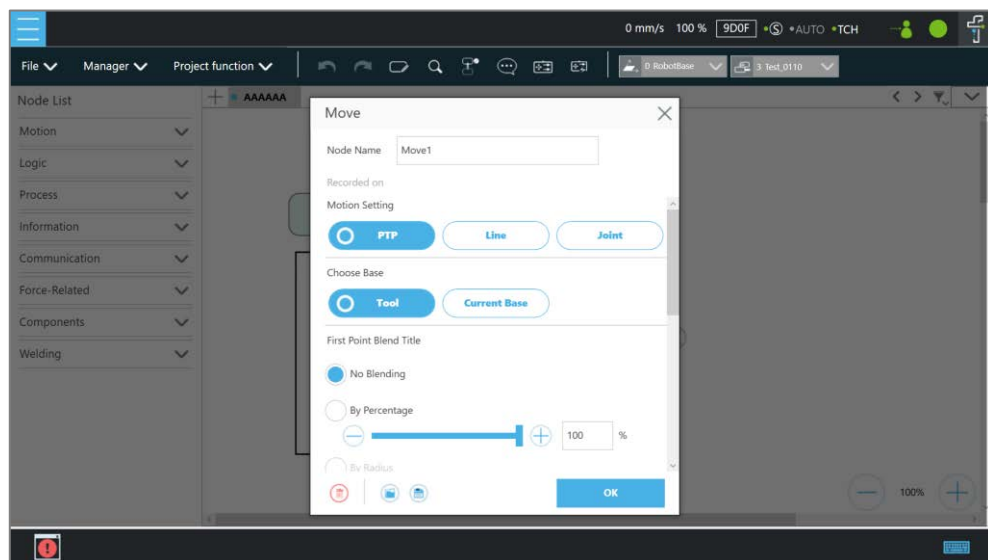

Figure 9 - 23: Move Node Setting

- Users can set joint angles to determine the relative movement of the robot.
- Users can set the relative movement of the distance and the angle.
- Users can replace the setting relative movement distance with a variable.
- In Joint, users can set the value of **Speed(%)** with the slider or in the respective field and

set the value of **Time to top speed** in another. Also, users can use the **{X}** button to set the number with a variable. The data type of the variable must be integer.

To choose a base in this node:

1. Click the pencil icon on this node.
2. Click on **Tool** or **Current Base** below **Choose Base**.
3. When the list prompt is displayed, select an item and click **OK**.

#### 1.42.3.1 Plan for the Move Node

As shown below, users can pick up the stack with a move node. By increasing the z value with each cycle, using the variable, by 5 cm, the four objects can be moved in four cycles.

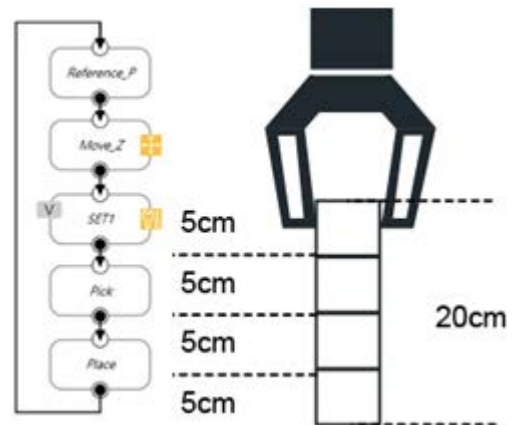

Figure 9 - 24: Plan for the Move Node

#### 1.42.4 Circle Node

##### 1.42.4.1 Circle Node Setting

The Circle node plans the path pass through point P2 (pass point) and end point P3, and uses P1 (current position) as the path start point, and plans an arc movement.

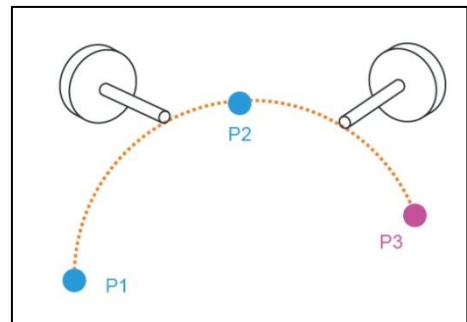

Figure 9 - 25: The Circle Node Plans Arc Path with 3-Point Setting Circle

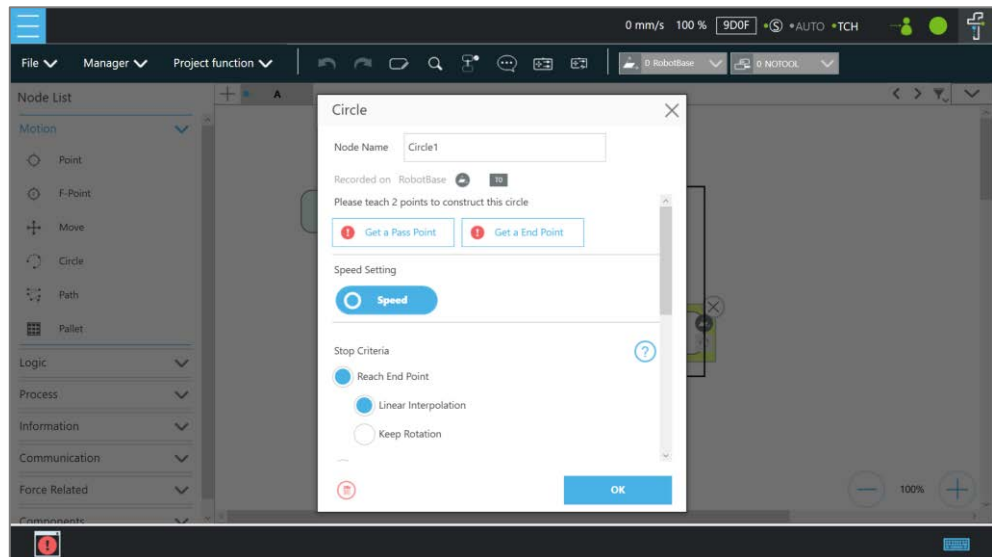

Figure 9 - 26: Circle Node Setting

To use the circle node:

- Step 1** Create a starting point before adding the circle node.
- Step 2** In the circle node, set the **Pass Point** and the **End Point**.
- Step 3** Define path arc length with angle.
- Step 4** Configure the **Speed Settings**.

#### 1.42.4.2 Reach End Point

In 3-point setting circle, users can define the path arch length, and the robot will move from P1 **Start Point** to P3 **End Point** through P2. Select **Keep Rotation** to make the robot move and not change its pose along the trajectory. On the contrary, select **Linear Interpolation** to make the robot move and change its pose along the trajectory as shown below.

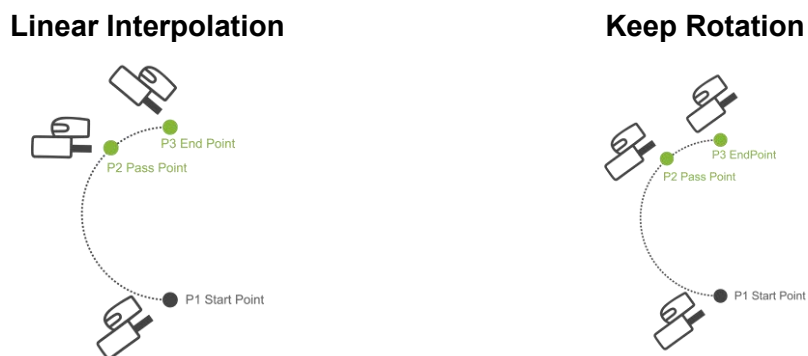

Figure 9 - 27: The Circle Motion Status of Reach End Point Setting

#### 1.42.4.3 Target Central Angle



Define the path arc with angle and the 3-point setting circle to make the robot move along the arc with the target central angle. The angle can be a variable in integer. Along the trajectory, the robot pose will not change after P1.

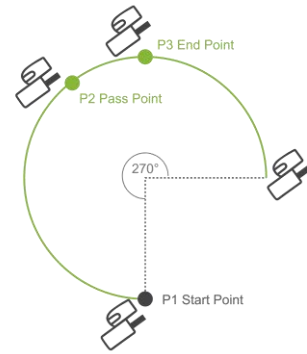

Figure 9 - 28: The Circle Motion Status of Set Angle =270°

#### 1.42.5 Path Node

This node can read and run the .Path file and control the robot to move according to the path in the .Path file.

##### 1.42.5.1 Path and PLine

The Path file is a collection of points that can be generated by a third-party CAD-to-Path software partnered with TM Plug & Play. PLine is a special motion mode of the Path file, and its blending setting is different from that of the Line, providing that the robot can smoothly move between dense points.

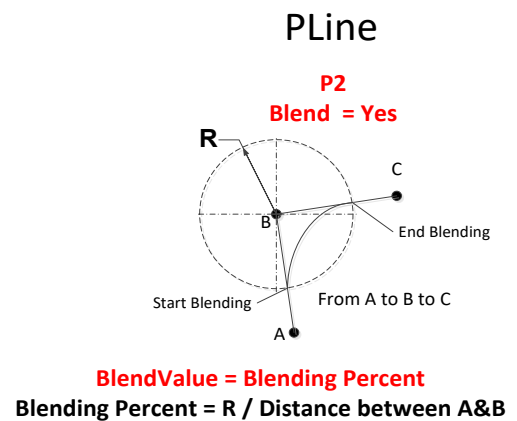

Figure 9 - 29: PLine Blending Relationship Chart

##### 1.42.5.2 Path Node Setting

- **Node Name:** Input the desired name in the field to edit the node name.
- **Path File:** Select Path to run from the Imported Path File or a string variable with a path file name.
- **Speed:** Set the speed percentage when the path is running. Applicable to the 1st point at the same time. Users can also check the box before **Link to project speed** to align the node speed with the project speed.
- **Data Type:** Select **Time** for motions with inconsistent speed or stops and **Position** for

consistent speed motions.

- **Direction:** Set to go **Forward** or **Backward** along the path.
- **First Point Motion Setting:** In the initial point setting, the PLine mode can be selected only when the 1st point of the path is PLine, and the speed setting is ABS. If selected **PTP**, users can set the **Target Type** to **Cartesian Coordinate** for the robot moving to the target point based on its Cartesian coordinates or to **Joint Angle** based on its joint angles.
- **Path Management**
  - **Path Property:** Path Property displays the **Tool** and **Base** of the **Path**. Users can also save new Path files and change the Base in this Menu.
  - **Path Task:** IO Setting of **Point on Path**.

Note

**NOTE:**

When selecting the point in **Path Task**,

1. the target point is the display parameter value plus 1. For example, the display parameter 0 denotes the first point of the path.
2. users can turn on Camera Module Light in Digital Out.

- **Advanced settings:** Base shifting / Tool shifting
  - **Change payload to:** If equipped, set the weight of the device at the end of the robot in kilogram.
  - **Precise positioning:** Whether moves to the point precisely

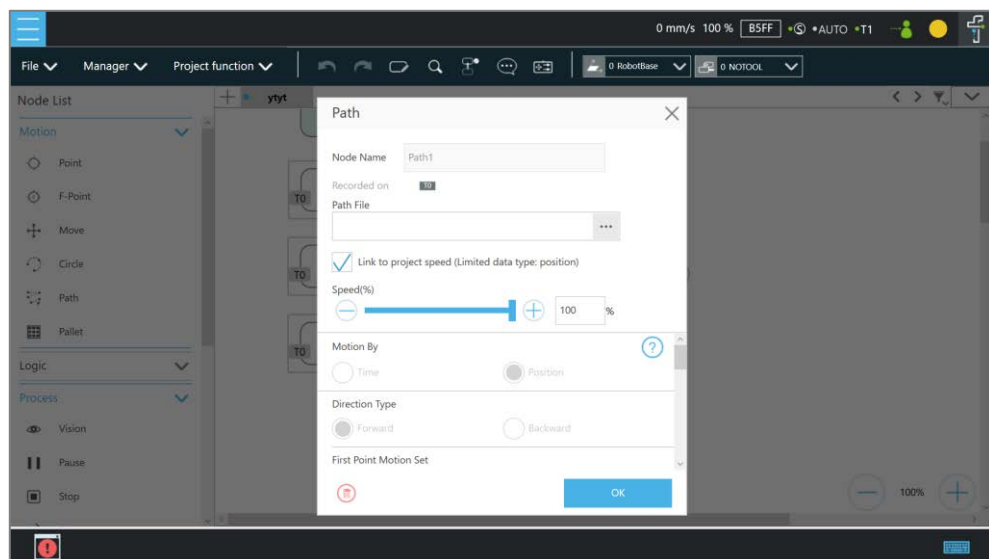

Figure 9 - 30: Path Node Setting

### 1.42.5.3 Path File Import and Export

Refer to 1.28.5 Import/Export for Path File Import/Export. When importing the **Path** file, import **Base** and **Tool** together, setting the same name of (i.e. Path1\_Base, Path1\_Tool) in the **Base** and **Tool** list of the flow. Path file import is only applicable to user-specified projects and preset with **Robot Base** and **NoTool** if there is no **Base** and **Tool** information. Users can also use the path file generated from **Path Generate**. Refer to I Path Generate for details.

### 1.42.6 Pallet Node

This node can set three-point coordinates and the values of row and column to control the robot's motion between the rows and the columns. There are a total of two modes, applicable to regular display applications, such as: pallet placement applications.

- **Pallet Pattern:** Set the pallet pattern that goes from the left or the right line by line with or without carriage returns.
- **3 points to construct this pallet:** The 1st **Point** is the start point of the 1st row and determines the robot posture. The 2nd **Point** is the end point of the 1st row, and the 3rd **Point** is the end point of the last row.
- **Number of Rows and Columns:** Define the number rows and columns.

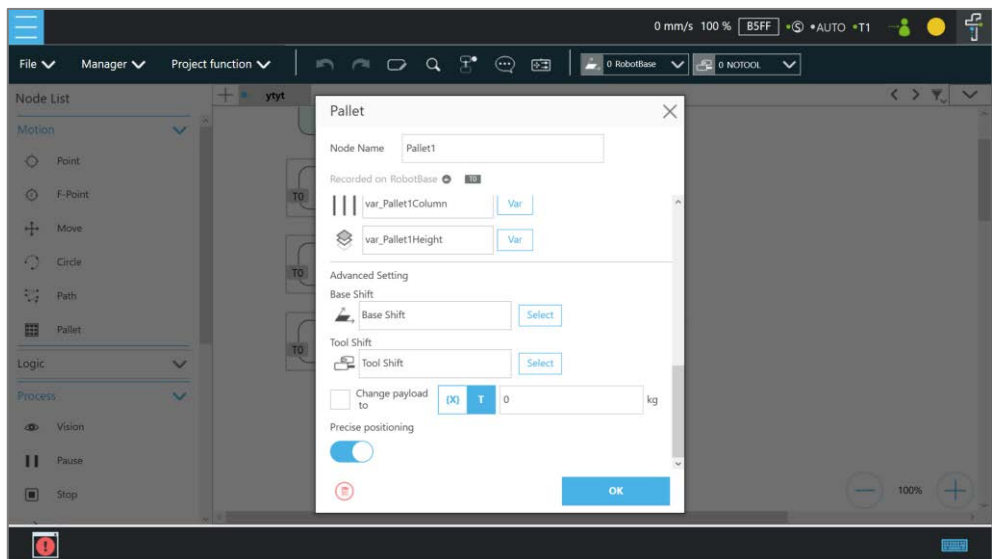
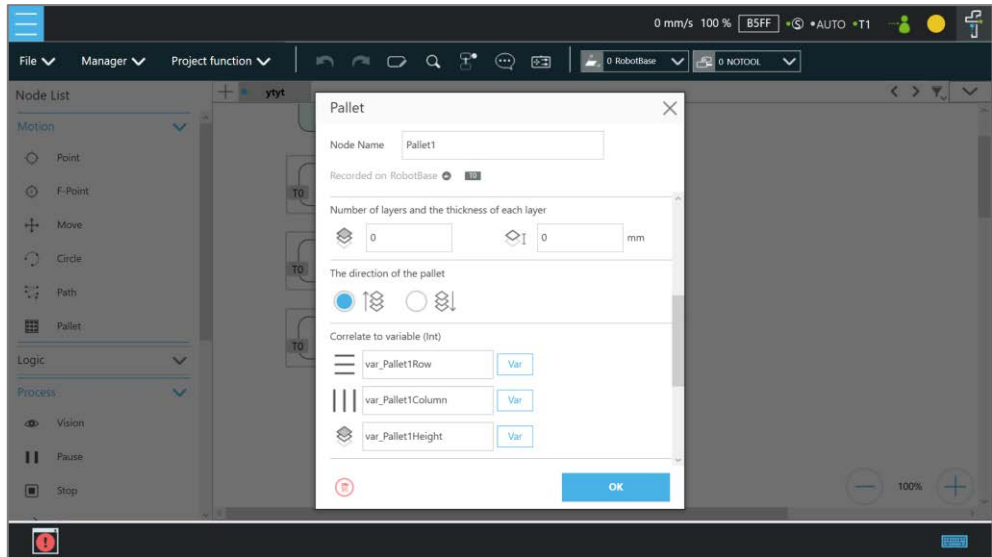
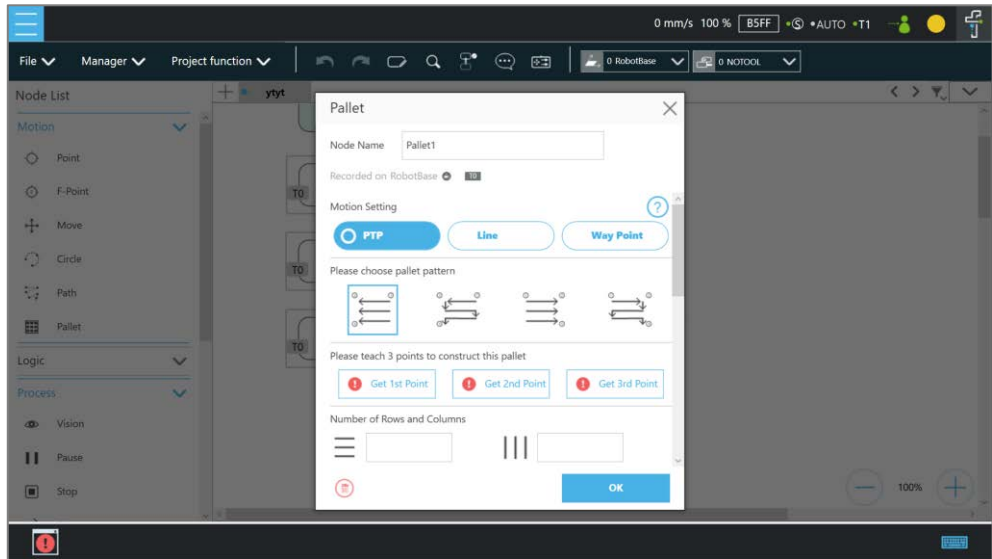

Figure 9 - 31: Pallet Node

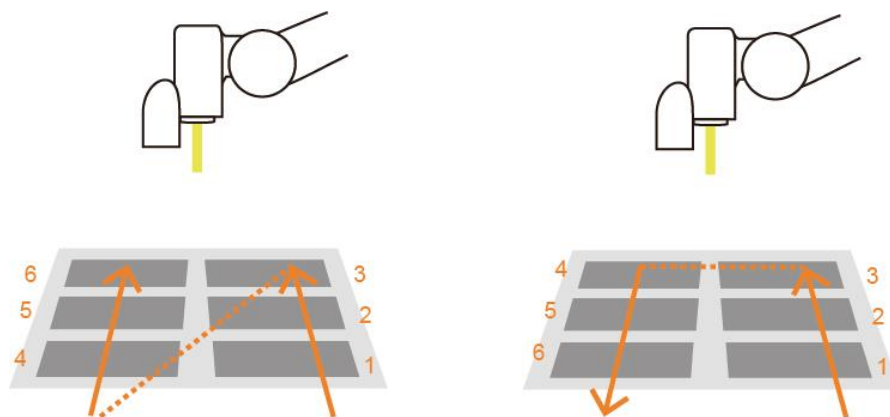

Figure 9 - 32: Pallet Patterns

- **Number of layers and the thickness of each layer:** Set number of levels and height of each level
- **The direction of the pallet:** bottom-up or top-down
- **Correlate to variable (Int):** Pallet will automatically generate a set of variables of row, column, and layer numbers, connected to Pallet movement position

Note

**NOTE:**

1. Users can use the function of **Correlate to variable** to correlate the row and column with variables. After variables are assigned to the row and column, the variables can be used to manipulate or display which slot in the Pallet is to be implemented. The amounts of the target column, row, and level are their correlated variables plus 1. For example, the target row is the third row, and the value of its correlated variable is 2.
2. Teaching points without following the sequence of the chosen pattern may result in the opposite of Z-axis.

**IMPORTANT**

**IMPORTANT:**

**Pallet** needs to work with a Loop in order to move to the next position of the **Pallet**.

### 1.42.7 Listen Node

In the Listen Node, a socket server can be established and be connected by an external device to communicate according to the defined protocol. All the functions available in **Expression Editor** can also be executed in **Listen Node**.

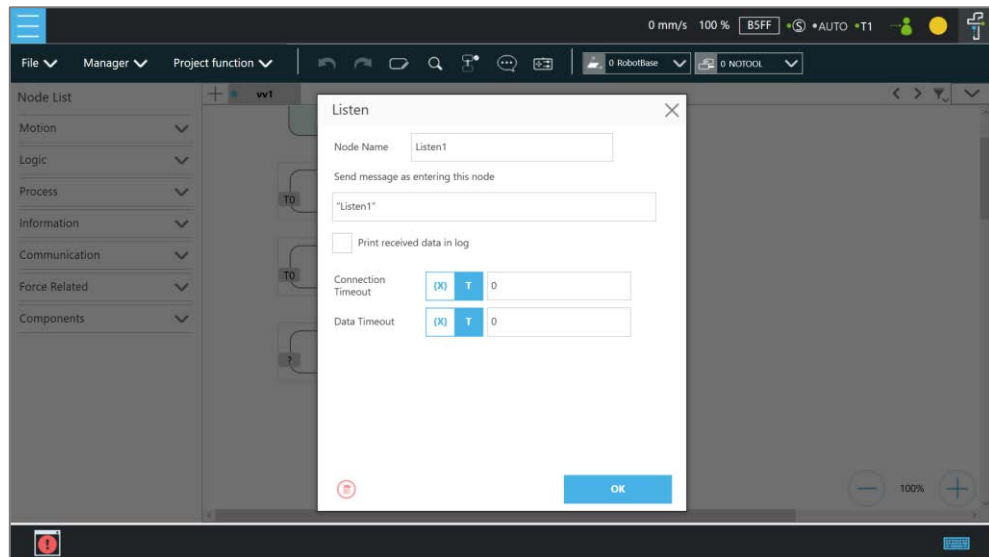

Figure 9 - 33: Listen Node

- **Send Message:** When entering this node, it will initiate a message
- **Print Received Data in Log:** Enable Communication Log (shown on the right)
- **Connection Timeout:** When entering this node, if more than the Connection Timeout (milliseconds) passes without connecting, it will timeout. If  $\leq 0$ , no timeout
- **Data Timeout:** When connected, the timeout will be exceeded if no communication packet arrives in Data Timeout ms. If  $\leq 0$ , no timeout

Socket Server is set up after the project is running and closed after the project is stopped. When the Socket Server is successfully established, the IP and Port will be displayed in the Notice Log window on the right.

IP        Human-Machine Interface → System → Network → IP Address  
 Port     5890

When the process enters the **Listen** Node, it stays in the **Listen** Node until it triggers and leaves with the exit condition.

Pass:    Executes ScriptExit() or item stopped

- Fail:
1. Connection Timeout
  2. Data Timeout
  3. Before the Socket Server been established successfully, the flow process has entered the Listen Node

---

The commands received by the listen node will be executed in order. If the command is not valid, an error message will be returned carrying the line number with errors. If the command is valid, it will be executed.

The commands can be divided into two categories. The first category is commands which can be accomplished in instance, like assigning variable value. The second category is commands that need to be executed in sequence, like motion commands and IO value assignment. The second category command will be placed in the queue and executed in order. Refer to *Programming Language TMsScript* for details on commands and communication format.

## Logic Programming

### 1.43 Overview

This Chapter will introduce the logic nodes commonly used in the flow project, explain its basic features and use methods, and let users understand how to let robots understand instructions and commands and determine the next motion. In the area of logic programming, the most **IMPORTANT** aspect is the application of variables. In **TMflow**, variables are mainly divided into two categories: **Global Variables** and **Local Variables**, therefore, this chapter will introduce variables first and explain how to assign them. It then covers basic explanations and examples of how the logic nodes are paired with these variables. The following will introduce logic programming through a flow project.

### 1.44 Variable System

#### 1.44.1 Local Variables

**Local Variables** can only be called in a single project, and their effective range is only within the project that created these variables. Variables are created through the Variable tab, at the top of the **TMflow** interface. In this page, a single variable or array variable can be declared and assigned a value. According to the different data formats, **TMflow** provides six types of variables: **int**, **float**, **string**, **double**, **bool**, and **byte**. The meaning of the variables is shown in the table below. If no value is assigned, a string initial value of empty, and the remaining variables default to 0. The newly added local variables will appear in the project's variable system, and begin with "var\_" to represent local variables in the variable system. Users can use dropdown to filter available variables in the list, and sort variables in the list with the buttons of reverse alphabetical, alphabetical, or chronological. Click the **Batch Delete** button to select multiple variables to delete. The exclamation mark denotes unused in the flow.



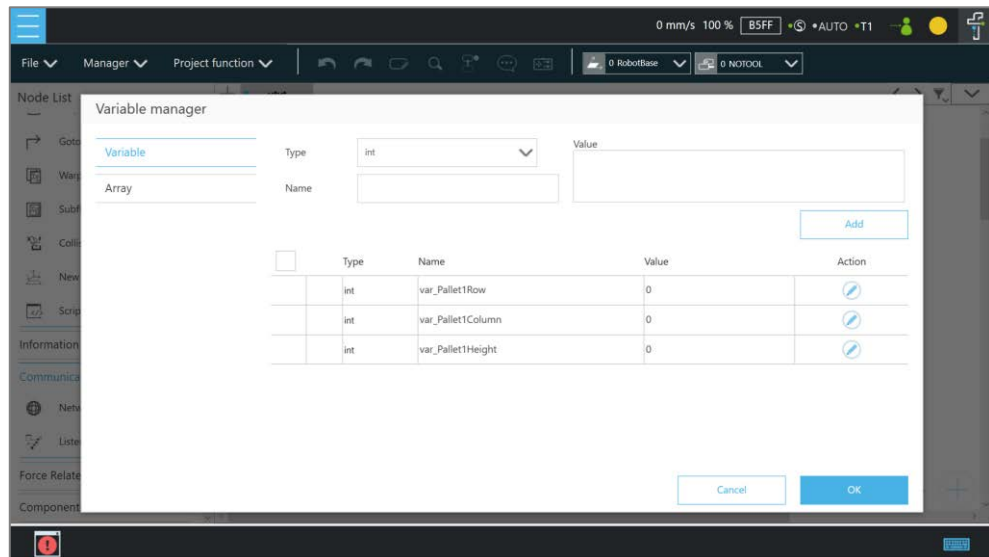

Figure 10 - 1: Variable System

Type	Type Description	Saved Data
string	String	Structure composed of characters, such as "TMflow" (double quotes must be added to enclose the string)
int	Integer	$-2^{31} \sim 2^{31} - 1$
float	Floating point number (decimal)	$10^{-37} \sim 10^{38}$ (Effective digit 6~7 digits)
double	Double-precision floating- point number	$10^{-307} \sim 10^{308}$ (Effective digit 15~16 digits)
bool	Boolean	True, False
byte	Byte	$-2^7 \sim 2^7 - 1$

Table 12: Variable Data Types

After clicking the newly added variable, the declaration of a variable can be performed. For example, the integer type variable `TM_Robot=0` can be declared.

In addition to declaring a single variable, variable arrays can also be declared. The array declaration method is to set the name of the array variable and the size of the array. The default size is 0. As an array with size 10 and name `Array` is declared, the Array `{0, 0, 0, 0, 0, 0, 0, 0, 0, 0}` can be obtained. If users want to obtain the first value of the array, `Array[0]` can be called in calling the array **SET** Node.

To edit a variable or an array, select the item and click the pencil icon. For variables or arrays, the data type is not editable, and for arrays, the array size is not editable, either. Users can edit variables or arrays with naming starting with `var_` only.

**IMPORTANT**

**IMPORTANT:**

The number of first element of the array is 0.

### 1.44.2 Global Variables

Users can click **Global Variable** in the manager under the project to access **Global Variables**. **Global Variable** values can be accessed or changed in different projects.

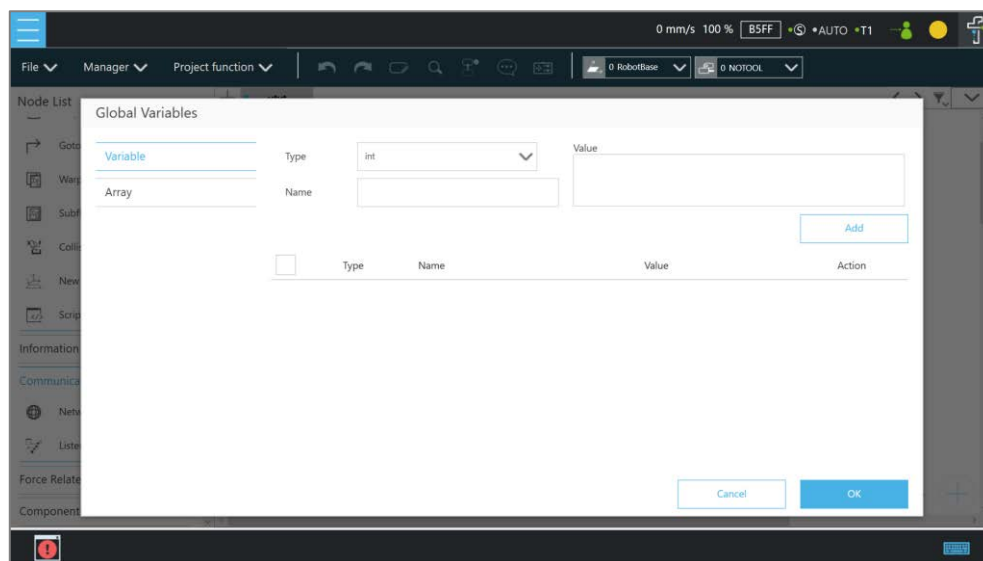

Figure 10 - 2: Global Variable Setting

Supposed users declare an integer type **Global Variable**. The newly added **Global Variable** will appear in the project's variable list, and it will be represented as a **Global Variable** starting with "g\_".

If, for example, users create a global variable with a name of 'a', this will be displayed by TMflow as "g\_a", indicating that it is a global variable. The global variable "g\_a" defaults to a value of zero. If the SET node increments the value of "g\_a" by one each time it is executed, after running the project 66 times the value of "g\_a" will be 66. At this point, any other project that accesses "g\_a" will get the value 66 for the variable.

**IMPORTANT**

**IMPORTANT:**

**Global variables** will not be re-initialized when the system shuts down. They will retain their value.

## 1.45 Logic Nodes

### Note

#### Note:

Due to the limited I/O status refresh rate of the system, Safety I/O status reading is designed for monitoring mainly. Conditional statements in logical nodes such as If Node and Gateway Node involving in Safety I/O statuses are not recommended, otherwise the project may not execute as users expected.

### 1.45.1 Start Node

In this node, users can view and set the initial state of the current project such as the initial project running speed in Manual mode (the initial project running speed in Manual Mode is fixed at 5% by default). Also, users can reset the states of DO and AO at the beginning of the project to initialize DO and AO before the project starts. Check **Enable continuous motion** to prevent the IO writing from interrupting the robot moving along the path of points for a smooth process of moving. **Enable continuous motion** is unchecked by default. Check **Enable busy loop optimization** to keep from intensive uses of CPU due to the busy loops.

### Note

#### Note:

More than 20 threads of execution will overload the system. There is no way to reduce the loading even if checked **Enable busy loop optimization**.

### 1.45.2 SET Node

This node can set the states of IO, and change the type and value of variables. When passing through this node, all parameters in the node will be changed to the set result.

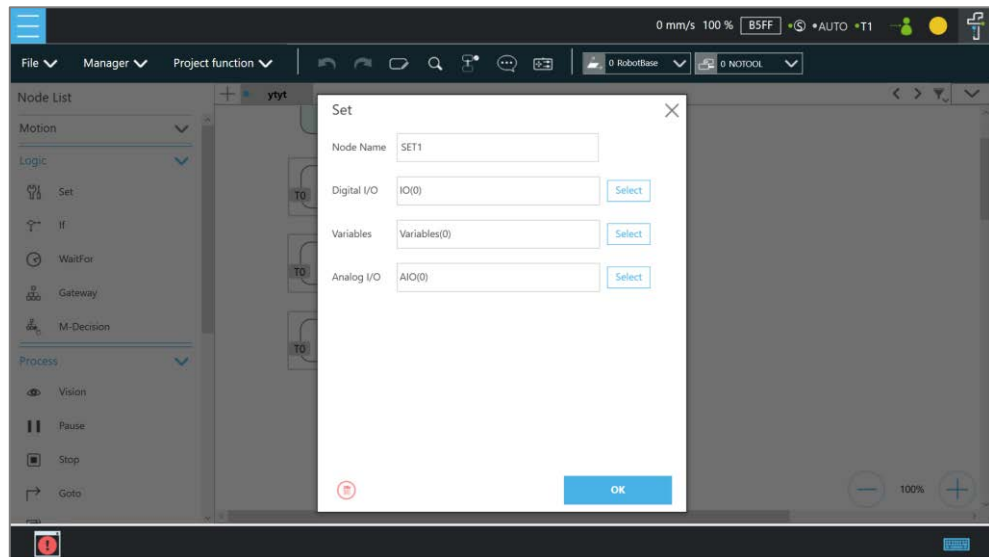

Figure 10 - 3: SET Node

In the application of variables, the **SET** Node can add and subtract variables, associate with the **IF** Node to select the path, or interrupt the infinite path of the project. As shown below, set an integer type of variable count = 0. Each time it passes through the **SET** Node, the count value is incremented by 1. Users can use Display to show the number of times the project has been run.

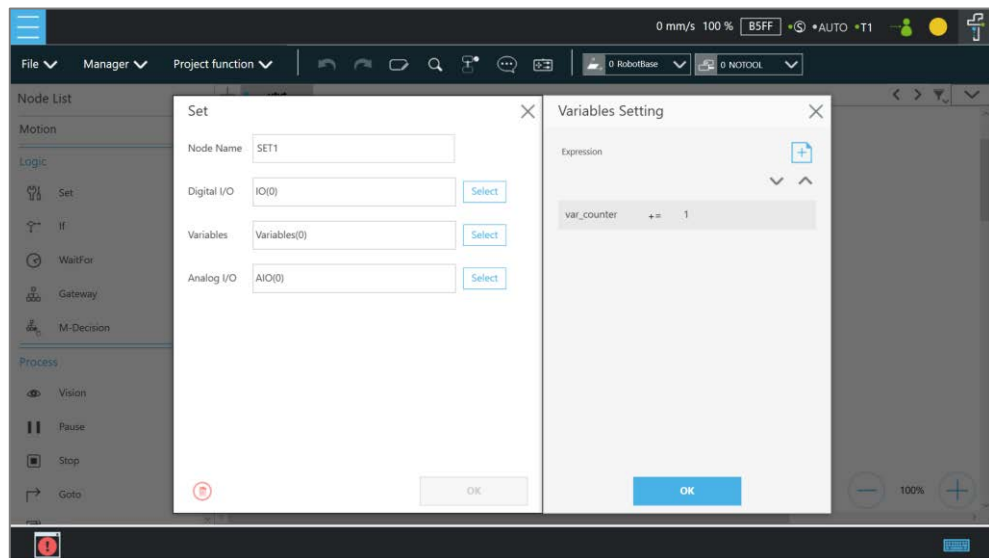

Figure 10 - 4: Variable Count

Syntax	Description
$a += b$	$a = a + b$
$a -= b$	$a = a - b$
$a *= b$	$a = a * b$
$a /= b$	$a = a / b$
$a = b$	Specifies the value of a is b

Table 13: SET Syntax List

Note

**NOTE:**

**Point, Base, TCP, VPoint, IO, Robot, and FTSensor** in the flows are now parameterized, and users can write variables as parameters to the objects and read from the parameters for calculations or applications with their types, Name/IDs, and attributes. For more details, Refer to *Programming Language TMsript*.

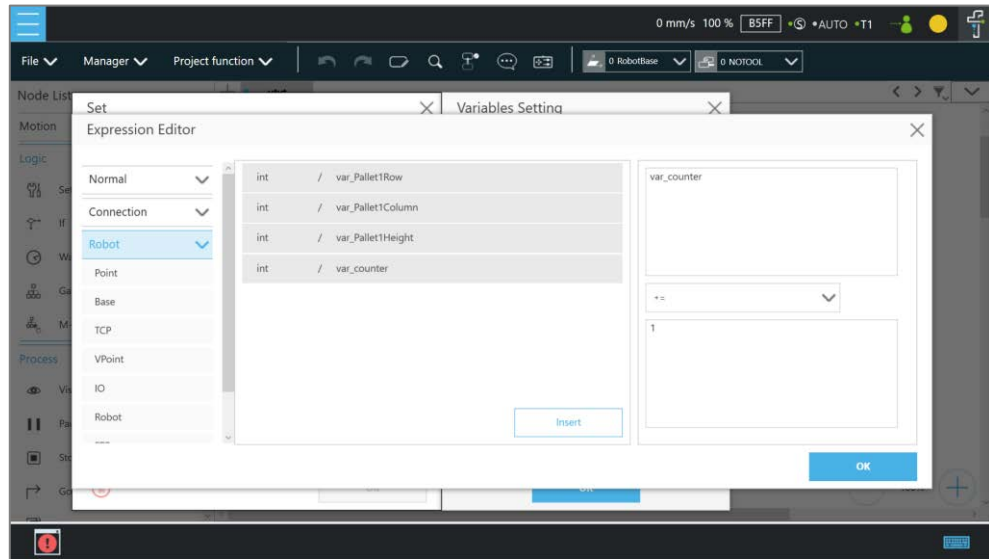

Figure 10 - 5: Expression Editor Parameters (1/2)

Note

**NOTE:**

1. Using parameterized objects is the same as using user-defined variables. Users can use parameterized objects without declarations to get or modify the point data through the syntax in the project operations and make the robot move more flexibly. The expression comes with three parts: item, index, and attribute.
2. A base index is added to the base parameters to act as the choice of the bases, e.g. Base[ "(base name) " ,(base index) ].value[ ]. The default value is 0 if there is no number assigned to the base index.
3. Writing to the parameters of the base is added with the same syntax as shown above. Only the value is writable, and other properties are read-only.

If there are multiple equations in **Expression Editor**, users can click on the equation to move, and use the triangles to move the equation up and down for the process sequence.

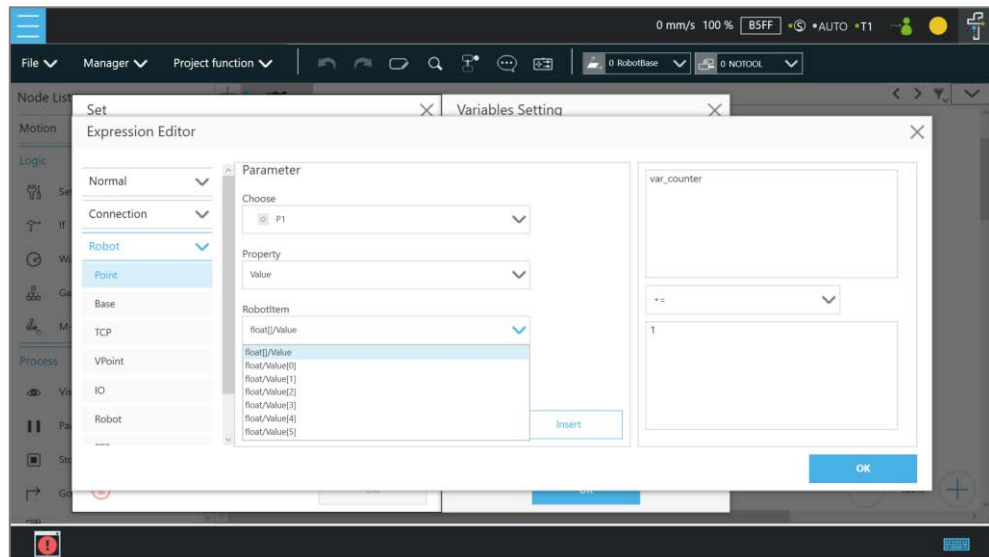

Figure 10 - 6: Expression Editor Parameters (2/2)

In the box below, the existing variables can be selected and used for calculation.

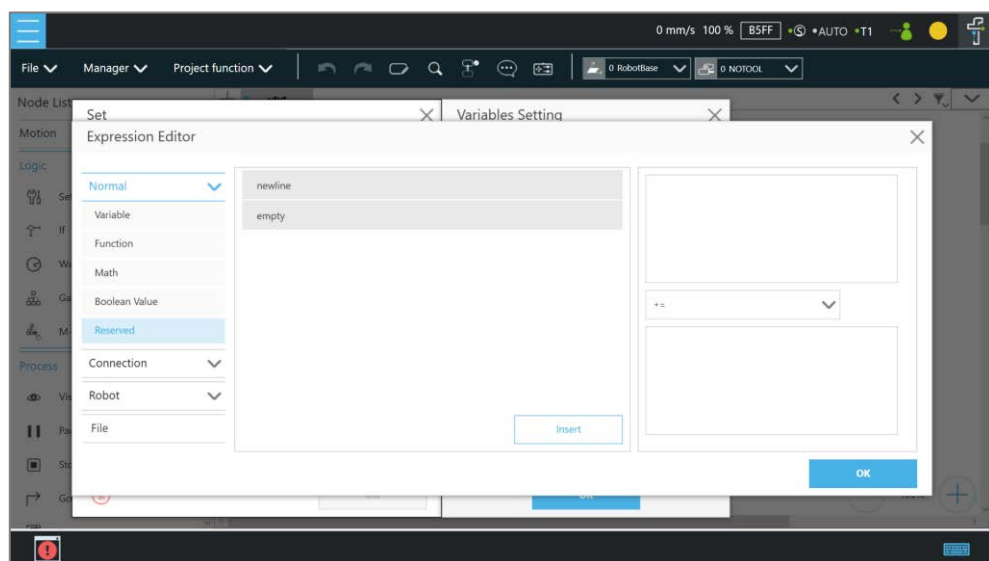

Figure 10 - 7: Add Expression

The **SET** Node can also set the **Analog IO** such as enabling **Analog IO** while passing through the **SET** Node and giving the external device a specific voltage until a different node stops the output voltage.

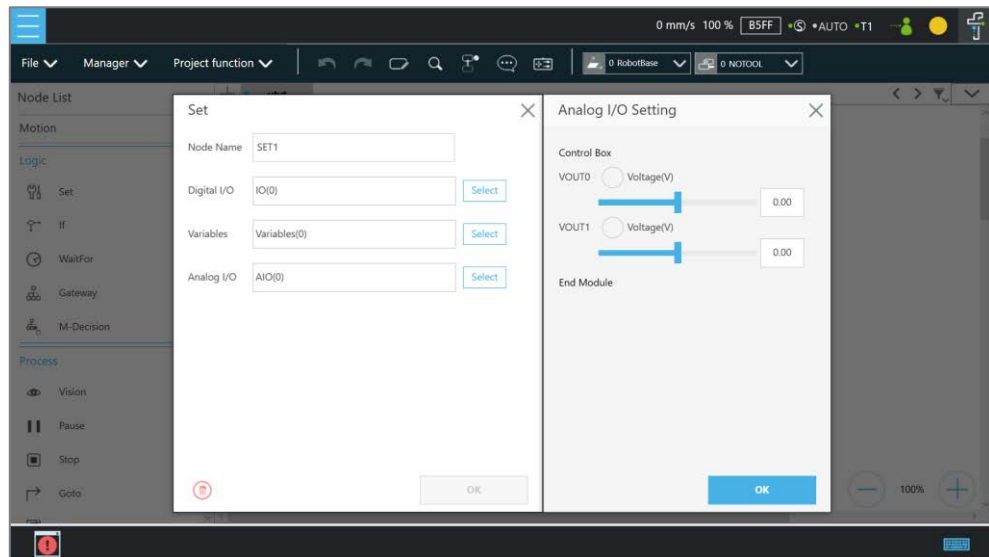

Figure 10 - 8: Analog I/O Setting

### 1.45.3 IF Node

In real robot operations, different conditions may result from many factors. For example, job failure, success, and communication errors may occur in various function nodes. These results will return the corresponding variable values. Users can use the **IF** node to handle these conditions according to different variables. The **IF** node can judge or compare the state of IO, the state of a **Variable**, and judge the state of **Compliance** as well as take the **Yes** or **No** path according to whether the condition of the judgment is reached. Click the field next to **Node Name** to change the name of the node.

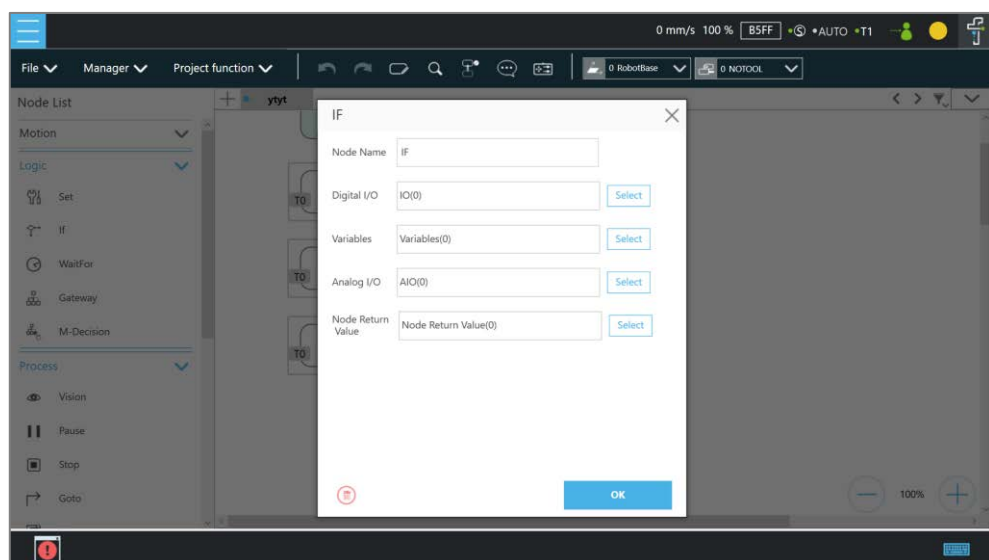

Figure 10 - 9: IF Node

Operator	Description
<	Less than
>	More than
==	Equal to
<=	Less than or Equal to
>=	More than or Equal to
!=	Not Equal to

Table 14: If Judgment Operators

In the judgment of stop criteria, as shown in the figure below, the variables obtained from the result in this project are used to program the following flow.

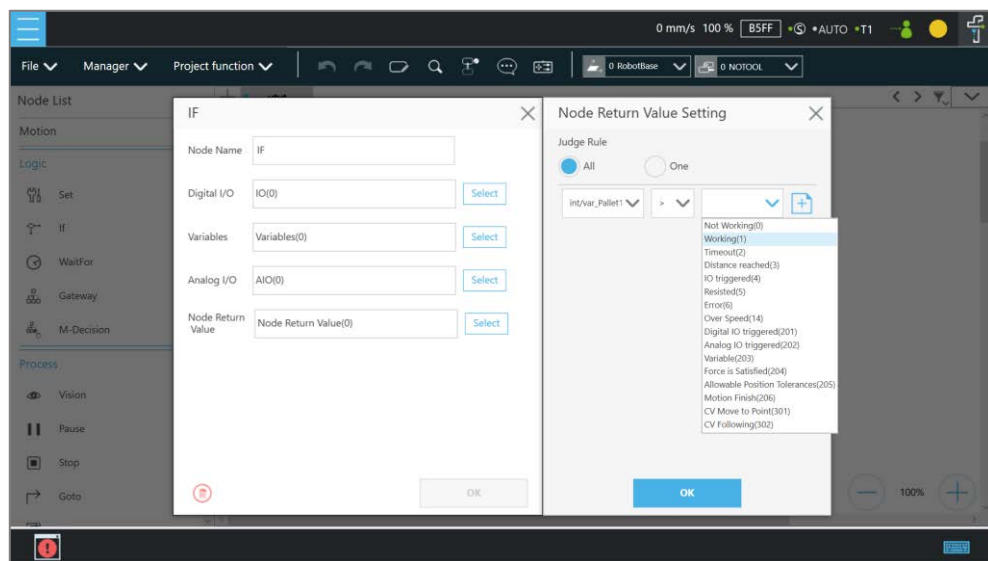

Figure 10 - 10: IF Node Stop Criteria Setting

#### 1.45.4 WaitFor Node

The main function of the **WaitFor** Node is to hold the project, and continue to run after the set conditions are met. It can be set according to **IO**, **Time**, **Variables** and other conditions to judge whether to resume the run.

#### 1.45.5 Gateway Node

The **Gateway** node is a conditional judgment formula which is similar to **IF** Node. Instead of output as **YES** or **NO** (**IF** Node), the **Gateway** node has a corresponding number of sub-nodes called **CASE**. When the project flow reaches a **Gateway** node, **CASE** would be judged from the list in **Case Settings** with a top-down approach. Users can use the arrows up and down to reorder the cases. If any condition is met, the project flow would continue from the output of that **CASE** sub-node, and the judgment of the rest of the **CASEs** are skipped.



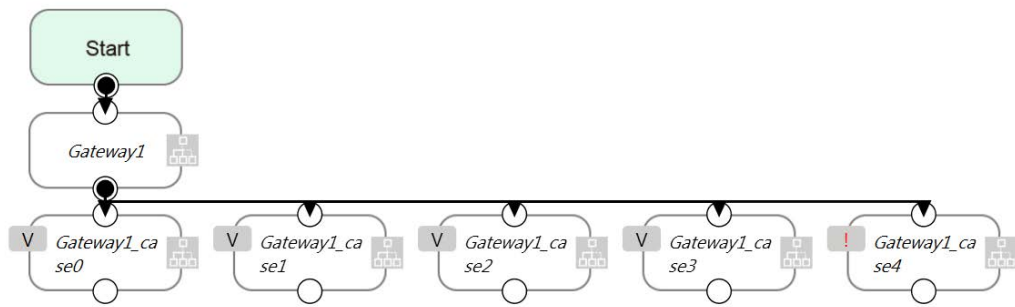

Figure 10 - 11: Gateway Node Judges Five Conditions

As shown above, there are 4 conditioned **CASEs** (and 1 **Default case**) which is relevant to using 4 **IF** Nodes as shown in the figure below. From the view point of simplicity, **Gateway** nodes can simplify the layout and increase visibility of the flow.

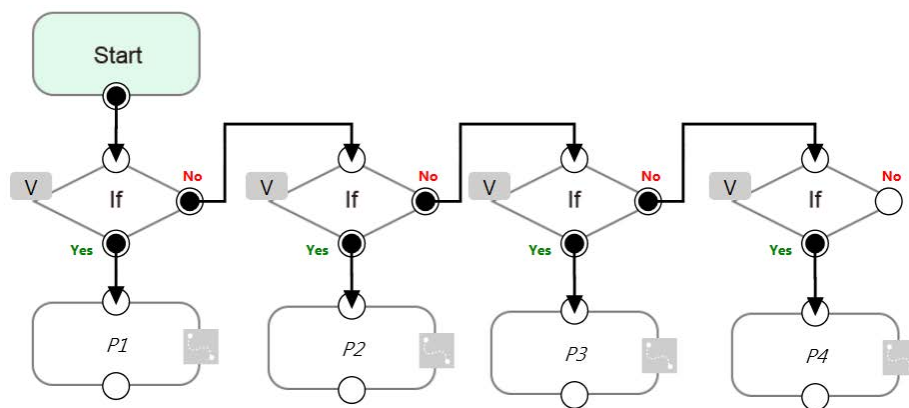

Figure 10 - 12: IF Node Judges Four Conditions



**NOTE:**

If no conditions are matched, the project flow would remain deadlocked at the **Gateway** node. Therefore, it is necessary to have a default case so that the project flow can continue which is practical by leaving the last case sub-node with no condition

1.45.6 M-Decision Node

The **M-Decision** node comes with respective numbers of sub-nodes called **CASE** similar to **Gateway** Node. When the project flow reaches a **M-Decision** node, the flow pauses and prompts users to decide the **CASE** condition. Once decided, the project flow would continue from the output of that **CASE** sub-node.



Note

**NOTE:**

- When the flow reaches the M-Decision node:
  1. Users cannot change the project speed.
  2. The message box prompts users making decisions in the view page, and only those who get control of the system can make decisions.
- M-Decision node is applicable to the main project flow, subflow, and thread.

### 1.45.7 Script Node

The Script Node allows users to rapidly and efficiently implement sophisticated logic and computations into a TMflow program using the scripting language. Refer to *Programming Language TMsript* for details on script programming.



Note

**NOTE:**

- Users can regard script nodes as listen nodes with no external device required.
- Since equivalent to a function, Script nodes are unavailable to define new functions.
- If using a script node in a thread, the motion-related functions are unavailable.

## 1.46 Process

### 1.46.1 Process Nodes

Flow nodes are mainly divided into four major categories: **Pause**, **Stop**, **Goto**, and **Warp**. The function of the **Pause** node is the same as the pause on the **Robot Stick**. If the project is running, and passes the **Pause** node, the project is paused. The **Robot Stick** can be used to override the Pause, so the project continues to run. Users can use voice function in a **Pause** node. The robot will read out the content when reaches the node.

The function of the **Stop** Node is the same as the **Stop Button** on the **Robot Stick**, as shown in the figure below. If the project is running, and passes the **Stop** Node, the project is ended. No node can be connected after **Stop**. If a **Stop** node does not exist in the flow, the project will not end automatically. It is necessary to press the **Stop Button** on the **Robot Stick** to end the project.

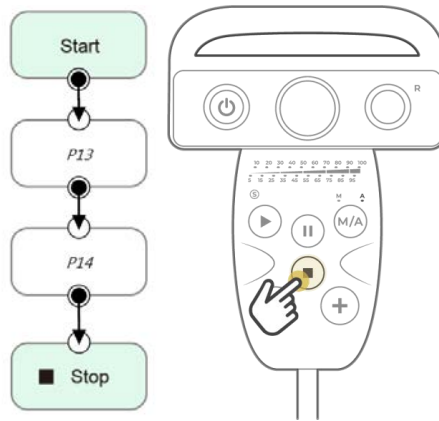

Figure 10 - 13: Stop Node Ends Project

The **Goto** Node provides users with unconditional transfer in the **TMflow**. When passing through this Node, it will directly transfer to the set target Node, as shown in the figure, to use the **Goto** Node. If the condition of the judgment formula is met, the next step transfers to P1 directly. Although the application of **Goto** can be achieved using the connection method, the complexity of the line will reduce the readability of the flow. The **Goto** Node will display the connection path only when the node is clicked, and the path of the connection will be displayed and indicated by red lines.

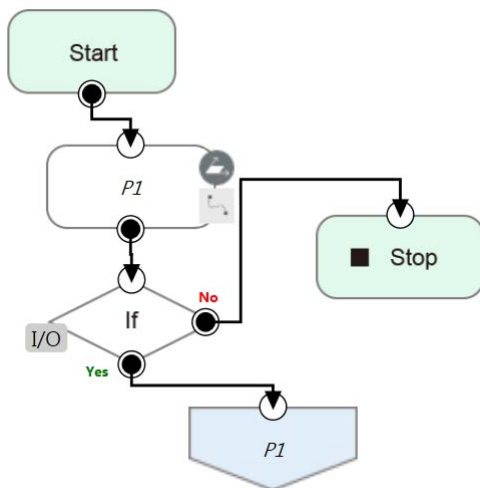

Figure 10 - 14: Goto Node Flow Transfer

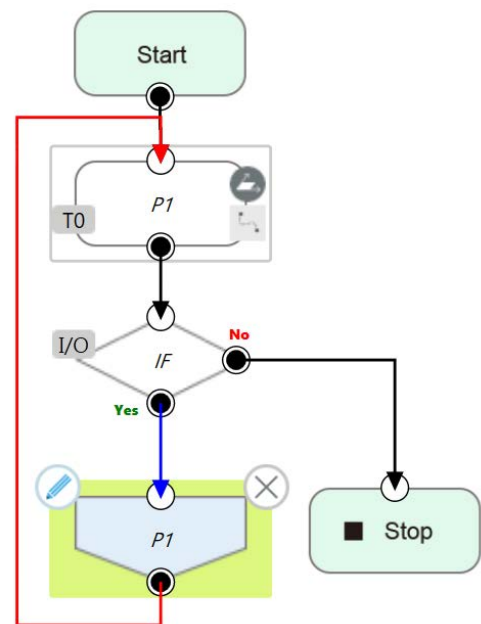

Figure 10 - 15: Goto Node Connection

The **Warp** Node transfers control the flow to another project and proceeds to run the target project. Nodes in the original project that occur after the Warp are not executed. The parameters

of **Variables**, **Base**, and **Tools** will not pass to another project. If users want to transfer **Variables** between two projects, **Global Variables** can be used. As shown in the figure, when the **TMflow** of project runs beyond the **Warp** Node, the execution is transferred to another project.

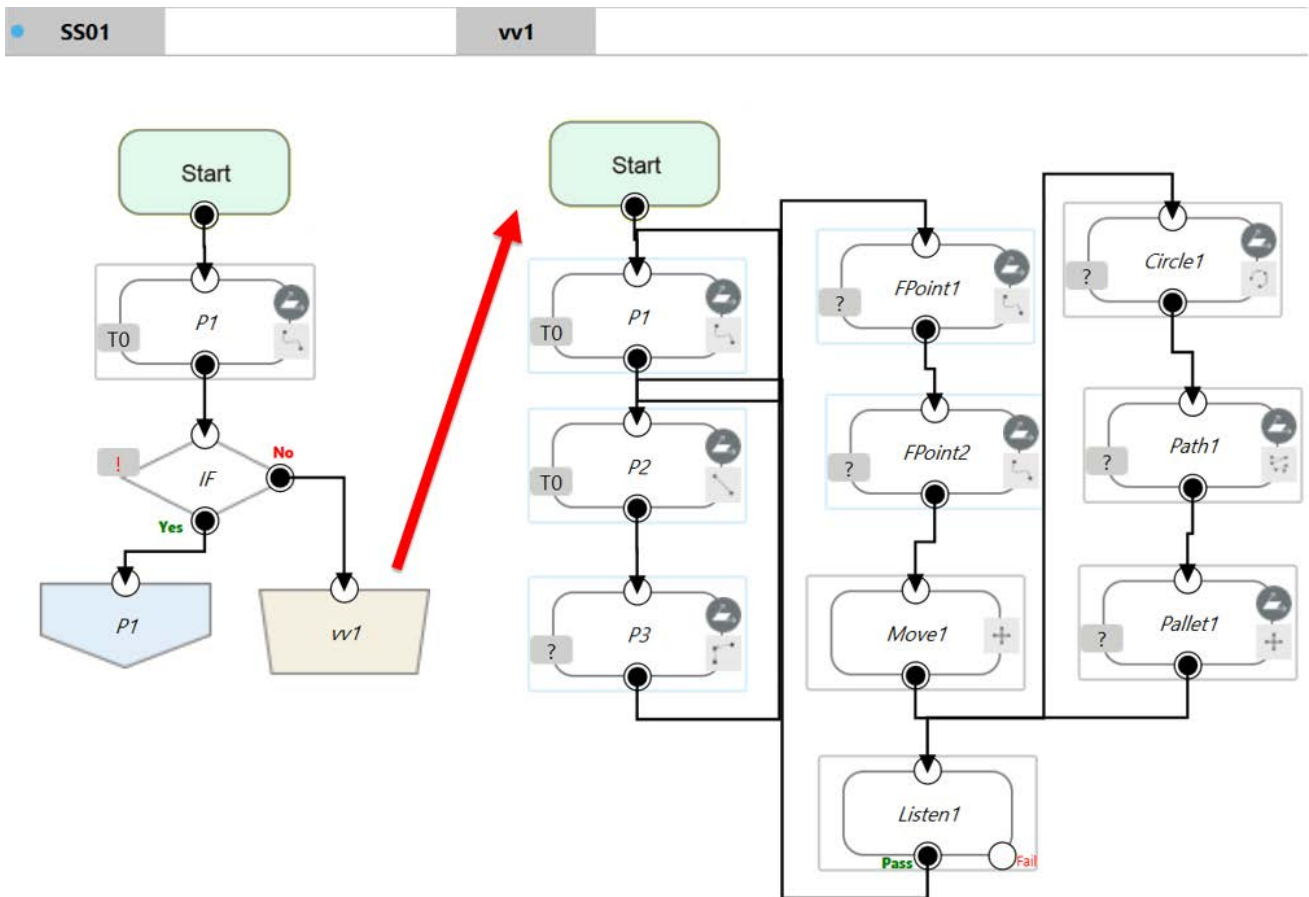

Figure 10 - 16: Warp Node Transfers to another Project

Since the **Warp** node applies to transfer the flow between projects, the time consumed to warp between projects varies from the mechanism for the initiations and the terminations of the projects. To run the **Warp** node at its best efficiency, mind each of the following as listed:

1. No warning while the project is running.
2. Do not insert the dongle key.
3. Operate in Auto Mode.
4. The warp target speeds up after running for the second time.

Note

**NOTE:**

Users can use variables of type string to store project names to warp.

### 1.46.2 Subflow Node

When the number of Nodes in the flow becomes large, certain blocks of the project may be used repeatedly. If the Nodes in these repeated blocks need to be modified, it may cause inconsistencies in the parameters; therefore, the **Subflow** Node of **TMflow** can be used. This Node will create a new page, and share the **Variables**, **Tool** parameters, **Bases** with the original page. The concept of modularization created with this method allows users to simplify the project editing flow, and improves the readability of the flow. During flow programming, it is recommended to use **Subflow** to simplify the whole flow, as shown in the figure, in this project the nodes running the same action only need to be programmed once.

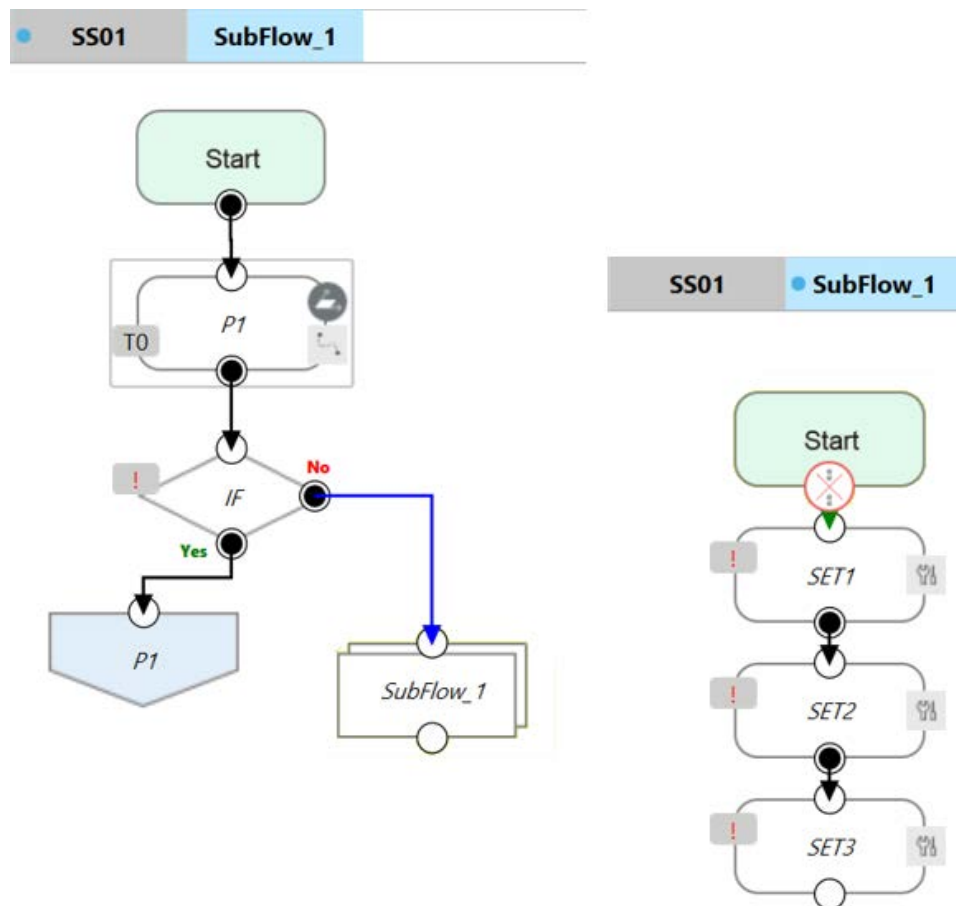



Figure 10 - 17: Subflow Node Modularization Concept

The **Subflow** Node can be dragged into the flow from the node list. If the current project does

not have any **Subflow** pages, a new page will be added automatically. If the current project already has **Subflow** pages, a query box will pop up, asking whether to create a new page. In addition, users can click  at the top left of the project editing page to add a new **Subflow** page, and connect the **Subflow** in the field of **Select Subflow** of the **Subflow Node**. If this page needs to be deleted, click the **Edit** icon of the **Start Node** in the **Subflow** page to delete.

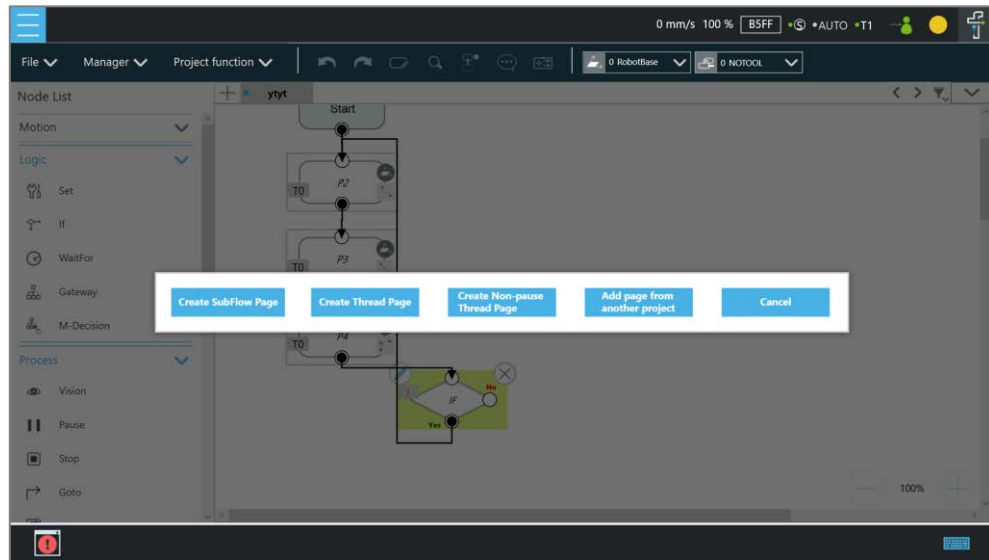

Figure 10 - 18: Menu to Create Subpages

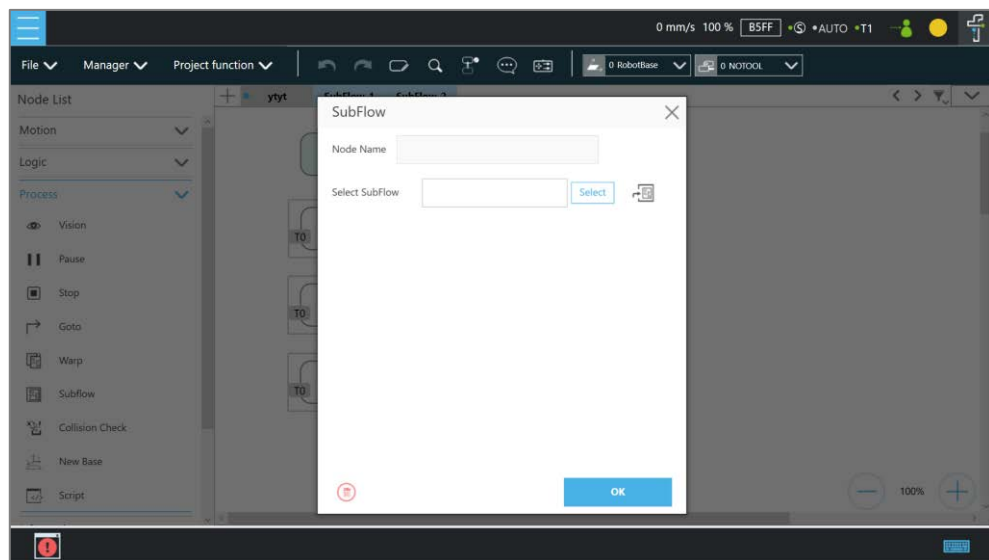

Figure 10 - 19: Select a subflow in the subflow node (1/2)

Users can click  next the field of **Select Subflow** to switch the tab of the flow editing page to the selected subflow in the background.

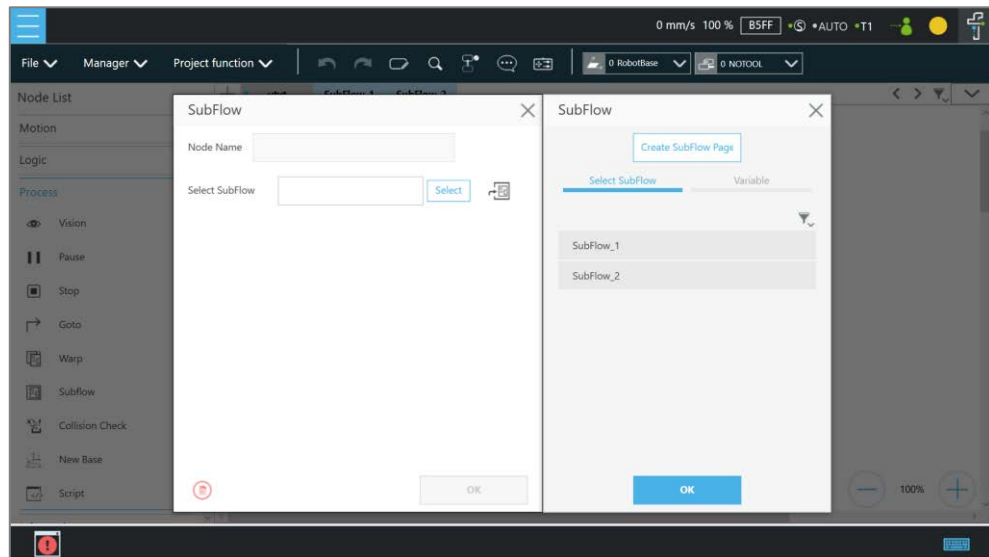

Figure 10 - 20: Select a subflow in the subflow node (2/2)

### 1.46.3 Thread

**TMflow** provides the function of **Thread**, allowing state monitoring and data acquisition to be independent from the robot. Click the query box popped up on the top left of the flow tab to add a **Thread** page.

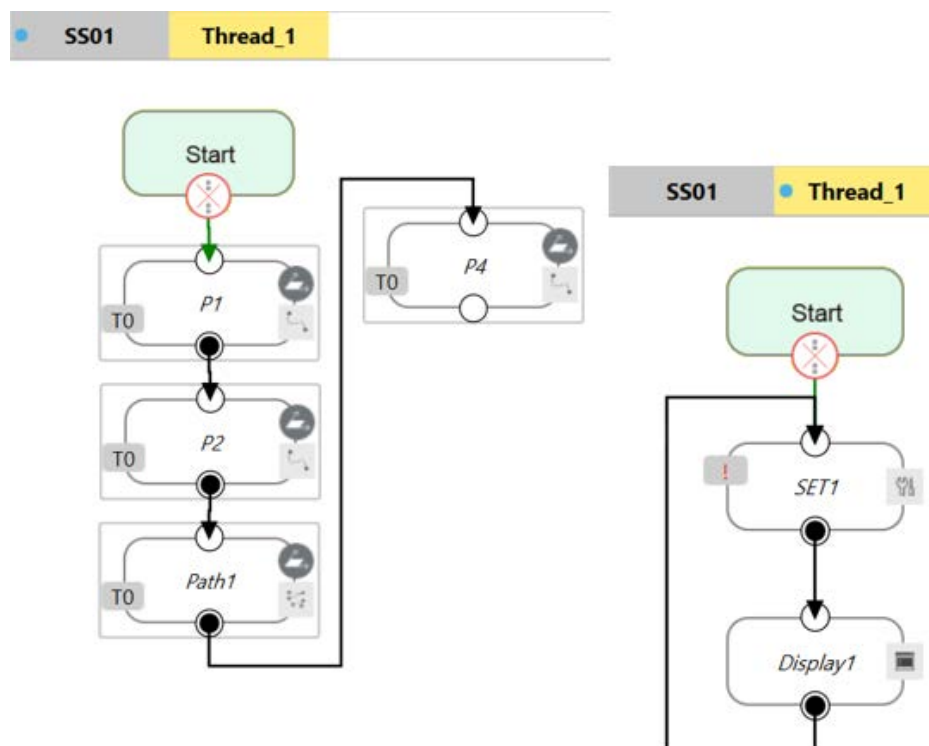



Figure 10 - 21: Thread

Inside the **Thread** page, only these actions can be added to the **Project Editing Page**: the logic to judge, and the value of the node to display. No motion node is available in the **Thread** page. There are two types of thread pages, the **Thread** Page, and the **Non-pause Thread Page**. When the project is paused, the **Thread** Page is also paused at the same time, and the **Non-pause Thread Page** does not pause so that users can still read data or update variables in the **Non-pause Thread Page**. To delete the page, click the **Edit** icon of the **Start** node in the subpage to delete.

#### 1.46.4 Add Pages From Other Projects

This function combines projects between different developers.

Steps to add a page from the other project.

1. Click  at the top left of the project editing page and click **Add page from another project**.

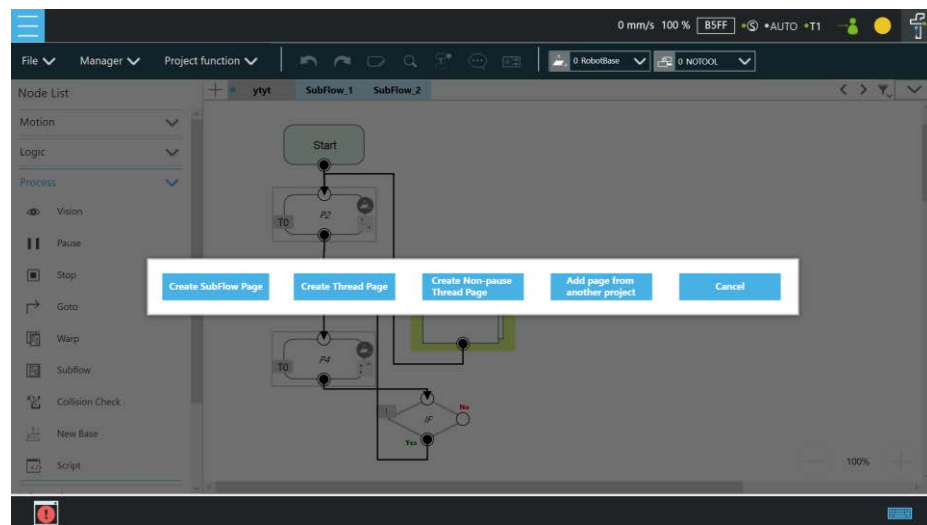
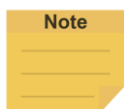

Figure 10 - 22: Add Pages from Other Projects

2. Select the project to add.
3. Select the page from project to add.
4. Add a new namespace for the page to add. (Avoid naming conflicts.)
5. Successfully added the specified page of the other project to the current project



**NOTE:**

- The main page from another project inserted into the current project will become a Subflow.
- The thread and non-pause thread will keep their characteristics.



- 
- If the names conflict, users can choose whether to replace them all
  - Comments from another project page are not going to be imported.

### 1.46.5 Vision Node

The Vision Node provides the creation of a plane with fixed-point type, servo type, and object type as well as a variety of AOI identification functions. The display of a Vision Node in flow, in the most complicated situation, each affiliate icon is shown in the figure below: The Base icon on the right side is for which Base is to record the Vision node of this Vision Job, and the Base icon on the left side is for which Base is to be generated by this Vision Job.

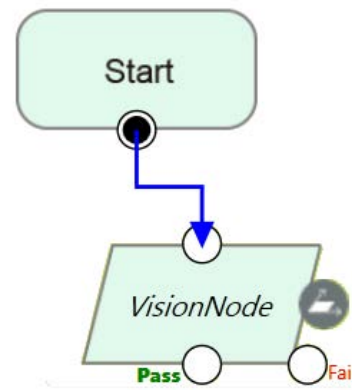

Figure 11 - 1: Vision Node

TM Robot records the relative relationship of objects by recording the points on different **Vision Bases**. If the environment changes, the robot can be compensated by coordinate transformation without re-teaching the robot's point positions. The position, as shown in the following figure, records the point P1 on the **Vision Base** to complete the task of pick, and performs the placement operation at the fixed position P2.

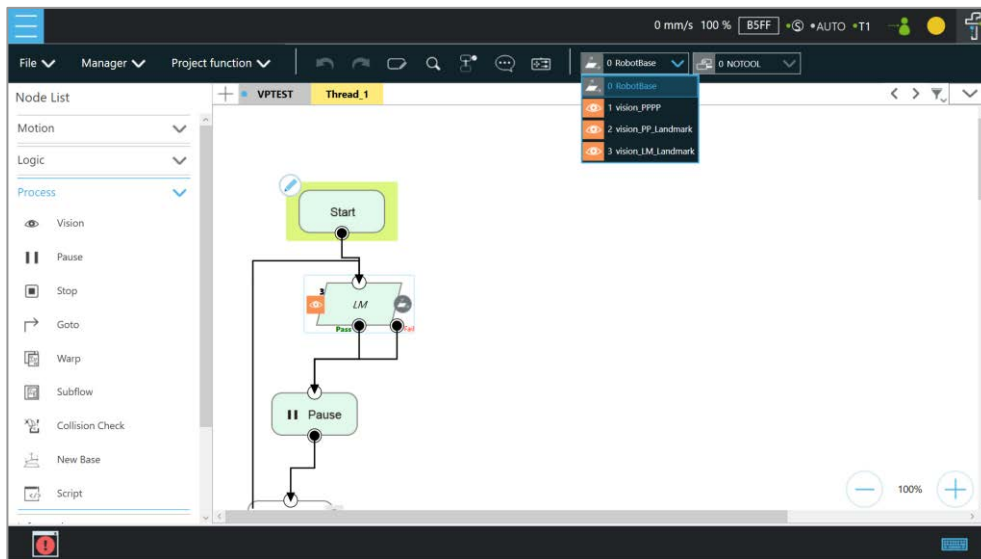

Figure 11 - 2: Vision Node Flow

Select a vision job to execute from the list in **Vision Job** or a string variable with a vision job file name. Part of the vision functions can generate **Variables** such as the string of the barcode, the number of objects, the color of identify, etc. The following is a multi-object recognition function, which outputs the number of objects found. In **Line of Motion Setting**, users can check the box next to **Link to project speed** to align the speed with the project speed.

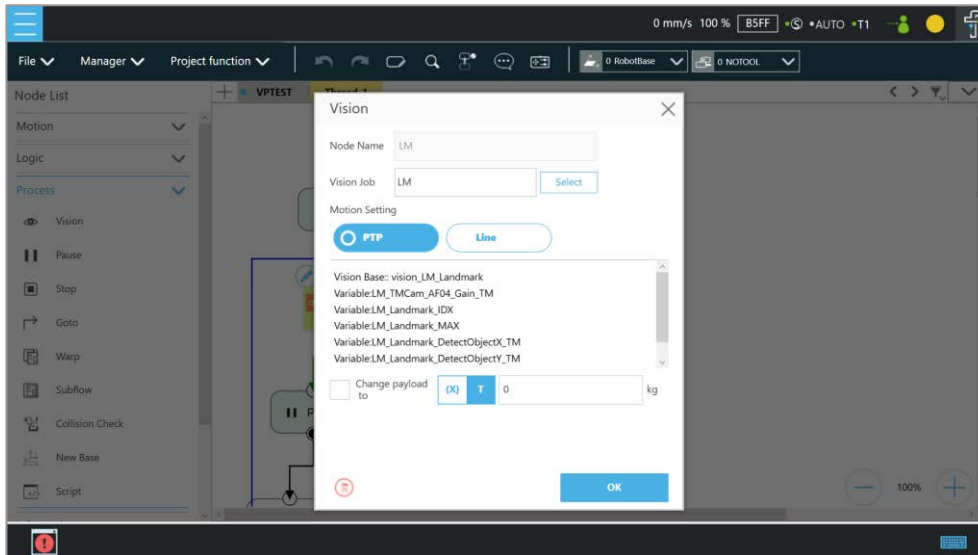

Figure 11 - 3: Vision Node Setting



**IMPORTANT:**

- When using the **Vision Bases**, make sure to choose the correct **Base** from the list on the upper right corner as **Current Base**.
- Do not use reserved words such as var to name vision jobs.

Refer to *Software Manual: TMvision* for further details.

### 1.46.6 Communication and Display

Users can communicate with external devices through the TM Robot-supported protocols (client-side), including Modbus, Network (socket), IO, etc. Users can easily use nodes for communication settings when using the flow project or declare a device. The following will introduce communication and Display through a flow project.

### 1.47 Modbus

Modbus is a Master/Slave type communication protocol. Users can use Modbus Master to read or write the parameters and save them in the robot register, such as position, posture and IO status. Users can program with the obtained parameters or monitor the status of robot. TM Robot provides two protocol versions of Modbus: Modbus TCP and Modbus RTU for users to get data from the external Modbus device or robot register. The external device, such as IPC or PLC, can also send commands to the TM Robot to get the related data as Master.

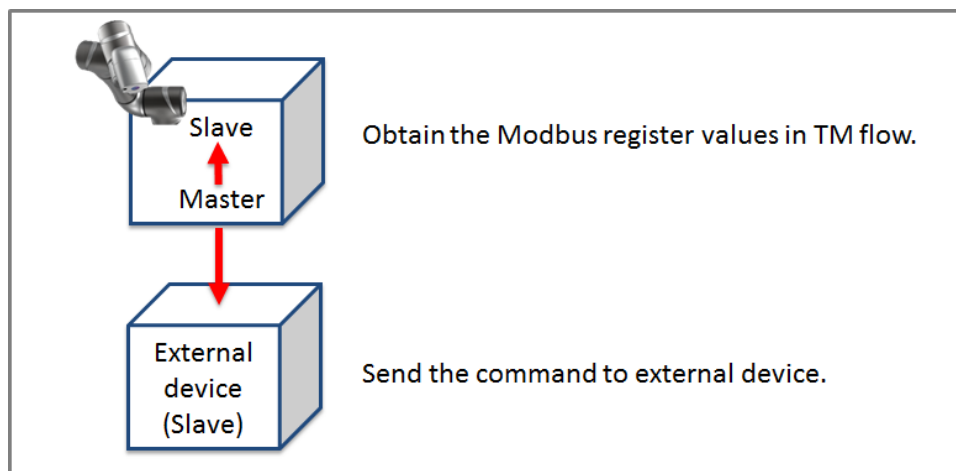

Figure 12 - 1: Robot Modbus Protocol

#### Note

#### NOTE:

Master is also called Client; Slave is also called Server.

### 1.47.1 Modbus System Hardware Structure

Modbus is divided into two protocol versions: Modbus TCP and Modbus RTU. Modbus TCP uses RJ45 for communication, and Modbus RTU uses a serial port for communication.

### 1.47.2 Modbus System Software Structure

#### 1.47.2.1 Set Modbus TCP

In the **TMflow** Setting page, click **Connection** to access the **Modbus Slave** Page, users must confirm that the IP is obtained in order to enable the Modbus TCP function. IP filter can set the network mask, and the communication with the robot must be in the set domain.

### 1.47.2.2 Set Modbus RTU

In the **Modbus Slave** RTU setting page, parameters need to be synchronized with the external device before use. After the parameters are confirmed, Modbus RTU then can be opened through the **Serial Port**, allowing the robot to communicate with different devices.

### 1.47.3 Application of Modbus in Project

The value obtained by Modbus can be used for many applications, such as writing the robot's status to an external device via Modbus. The settings inside the TCP / RTU devices are the same. The following will use the Modbus TCP reading the robot's x direction coordinates as the example for description.

Name	FC	Address <sub>10</sub>	Address <sub>16</sub>	Type	R/W
X	04	7001~7002	1B59~1B5A	Float	R
Y	04	7003~7004	1B5B~1B5C	Float	R
Z	04	7005~7006	1B5D~1B5E	Float	R

Table 15: TM Robot Coordinates in the Modbus List

First click **Modbus Device** from the list on the right side of **TMflow** to build the relevant parameters for the TCP device.

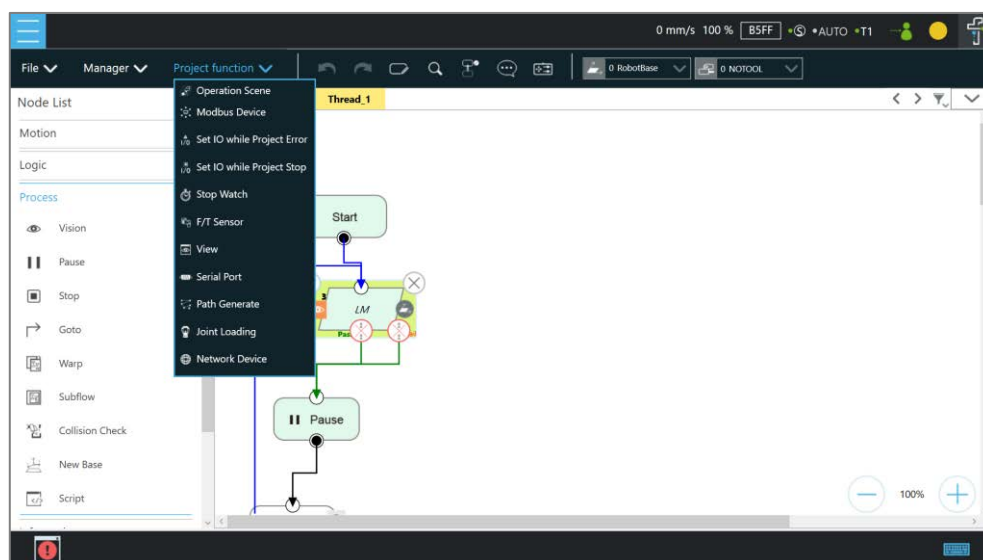

Figure 12 - 2: Modbus Device Access

After adding a **TCP** device, users can set the parameters of the **TCP** device manually, such as name, address and other related information, or import from IODD files supposed users have imported items and checked files in **Text File Manager**. Users still have to add the Modbus Devices and communication parameters manually. The only thing that IODD files do automatically is create the Address (Signal) Settings. After completing the setting, press **OK** to save. Using **TMflow** to get the robot parameters, users can directly use the preset local IP to operate. Then, click **Edit** to add the pre-read/write location in this device.



**NOTE:**

- To import IODD Files, make sure the files store in the path `\TM_Export\RobotName\XmiFiles\IODD` of a flash drive labeled **TMROBOT** where RobotName denotes the ID of the robot.
- To apply the imported IODD files for IO Link applications: Click the pencil icon of the item listed in **Modbus Device**, and click **Import from IODD**. Click the field next to **IODD File** to select the imported IODD file, and click **OK** when done to view the functions in **Modbus Device's Setting**.

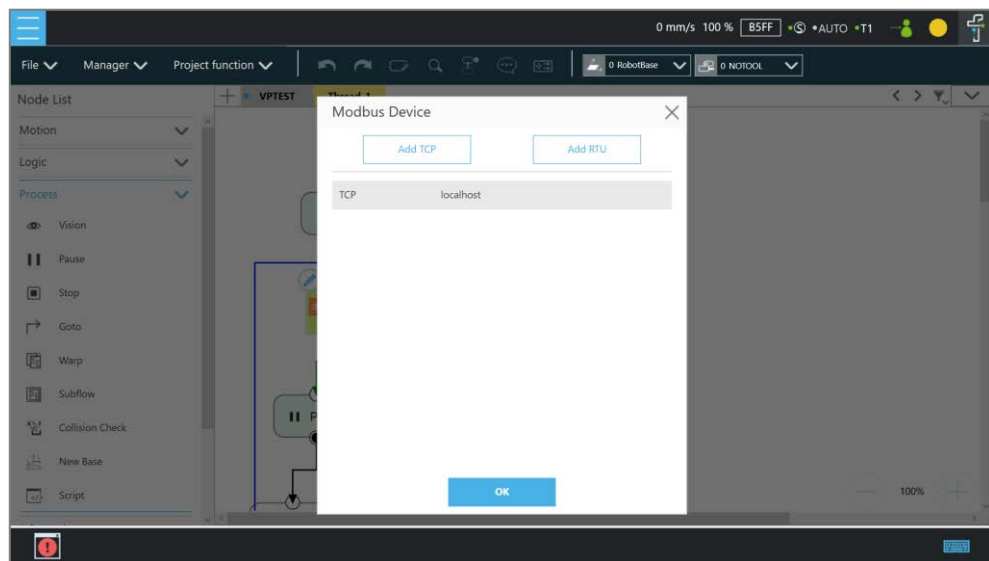

Figure 12 - 3: Modbus TCP Local IP

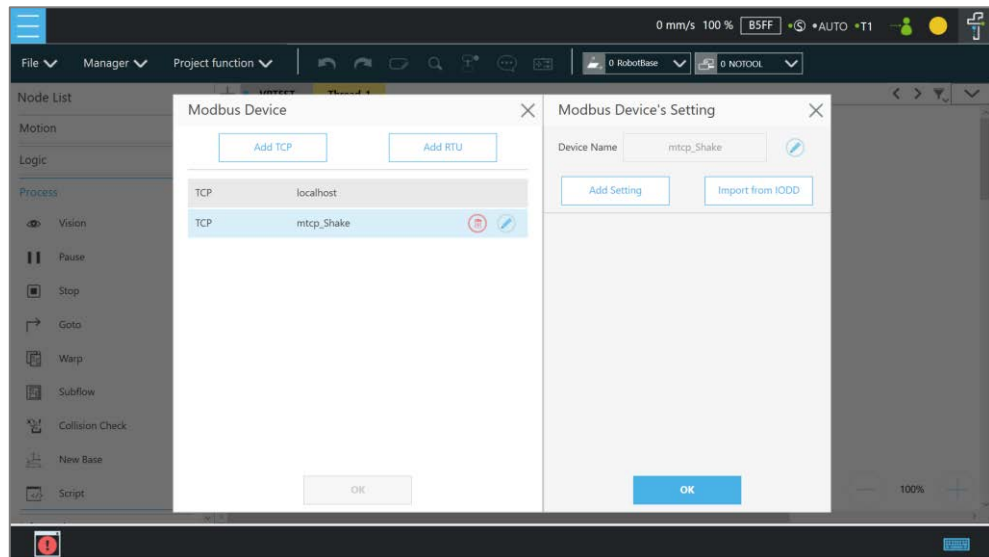

Figure 12 - 4: Modbus Device Setting



**IMPORTANT:**

If communicating with an external device, then it is necessary to set the IP address and related parameters of the external device.

Users can view the list of Modbus, in the lower left of the **Modbus setting page**, and input address of 7001, variable type as Float according to the list. After setting, users can program the Flow, and the subsequent maintenance can also be set using the **Modbus Device** on the right side. The following will use these settings to program Flow, and read the current X coordinate position of the robot. Users must create a variable to store the X coordinate value in the register.



**IMPORTANT:**

Big-endian is the high byte stored at the lowest memory address and must be checked here.

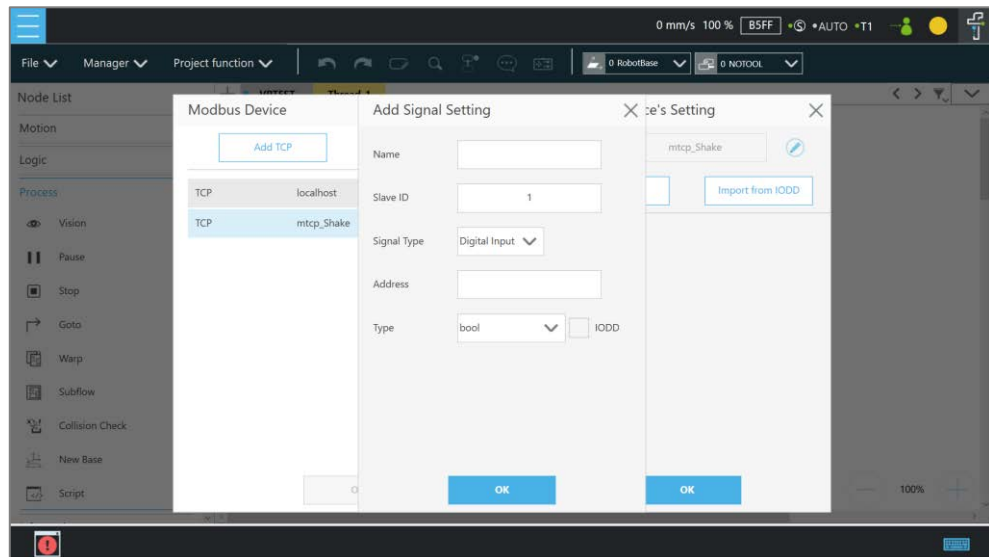

Figure 12 - 5: Modbus X Axis Position Parameter Setting



**NOTE:**

- The Modbus addresses for robot stick commands (Play/Pause, +, -, Stop) cannot be written to when the robot is in Manual Mode.
- Use the external device to read the Modbus address 7320~7321 for the last error code.

### 1.48 Network

Once all network parameters in the **Network setting** are set, users can use the **Network** node to have the robot communicate with the external devices through the network. Users are recommended to put the external devices and the robot on the same subnet. Refer to K Network Device for the external device settings.

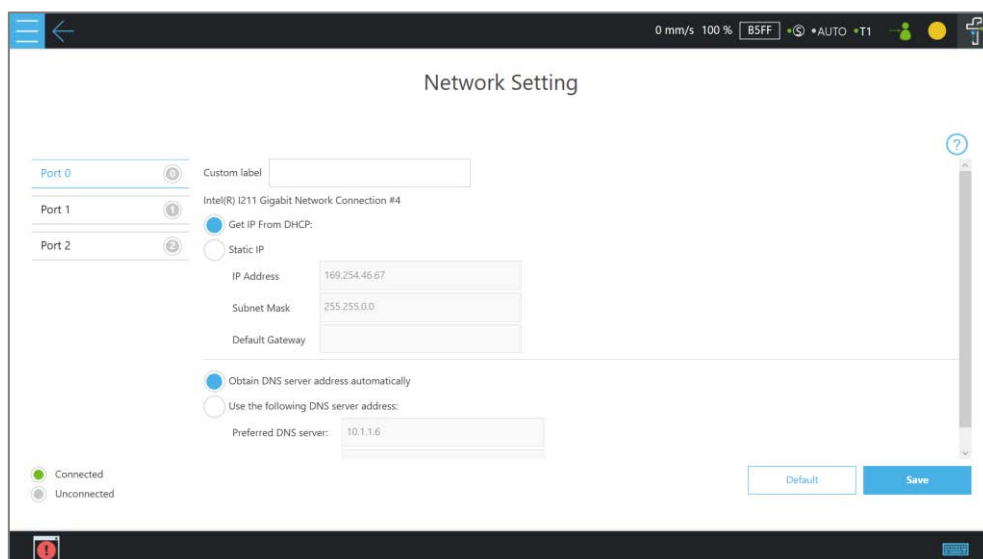







Figure 12 - 6: Network Setting

### 1.48.1 Network Node

The **Network** node can be set to communicate with external devices.

To set the **Network** node, follow the steps below.

1. Drag a **Network** node in the node list to the flow editing area.
2. Click the pencil icon on the node
3. In the field of **Node Name**, fill the desired name.
4. Select the device to communicate with in the box next to **Choose Device**.
  - To add a device: Click the **Select** button, and click . Enter the name, the IP address, the port number of the device into the respective fields, and click **OK**.
  - To edit or delete a device: Click the **Select** button, and select the device name in the list. Click the pencil icon to edit, or click  to delete.
5. Click on the bullet to select from either **Receive from variable** or **Send** for inbound or outbound traffic.
  - For **Receive from variable**, click on the box below **Variable** to assign a variable to store the inbound messages. In the box next to **Maximum received data time**, fill the desired maximum time in ms to receive data, or click  to select a variable to apply.
  - For **Send**, click on the bullet next to **Typing** to edit the desired message in the box below or click on the pencil icon to add more expressions to the box as the outbound message, or click on the bullet next to **Variable** and select a variable in the box to assign a variable for the outbound message.
6. In the field of **Extra Idle Time**, fill the desired time in ms, or click  to select a variable.
7. If you wish to know the connection status, click on the box next to **Connection Status**, and assign a variable from the list to have the variable store the connection status.
8. Click **OK** when done.

Note

**NOTE:**

1. The system will report an error and light in red if no device is in the node setting.
2. The network node is a client and therefore connects to a server only.

### 1.49 IO

TM Robot provides users with both digital IO and analog IO. Digital IO controls two states by H and L (High/Low). High denotes the output voltage of the **Control Box**, which is 24V. If Low, then the output

voltage is pulled to GND.

The **Control Box** configures 2 sets of digital IOs and 2 sets of analog IOs. Users can use the **SET** node to give the analog IO specific voltage (-10V~10V) to complete the job in actual operation.

#### 1.49.1 User Defined IO

Using **Self-Defined IO**, users can trigger or read the button on the **Robot Stick** with external devices through the IO ports on the **Control Box**. After the setting is complete, click **Save** in the lower right corner to save the setting.

Control Box Input channel	Definition	Control Box Output channel	Definition
10	Stick + button	10	Stick + button
11	Stick - button	11	Stick - button
12	Stick Pause button	12	Stick Pause button
13	Stick Play button	13	Stick Play Button
14	Stick Stop button	14	Stick Stop Button
		15	System Error Indicator

Table 16: User Defined IO Setting Table

#### 1.49.2 External IO

TM Robot provides external IO extension functions, which can be extended by the TM Plug & Play EtherCAT IO extension modules and the added IO interface port can be called by the controller to test, and to complete the flow programming by the **SET** node.

#### 1.49.3 Status IO

Status IO is used when the project is stopped or in error. The status of the IO is changed to the set value according to these conditions and can be accessed from the **Project Function Menu**. Click the icon "**Set IO while Project Errors**" or "**Set IO while Project Stops**" to access the setting page.

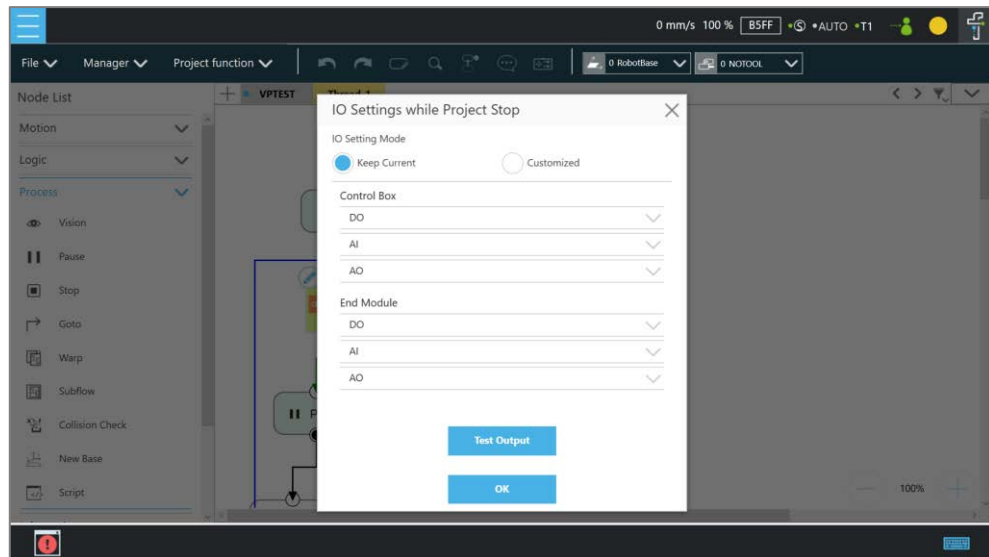
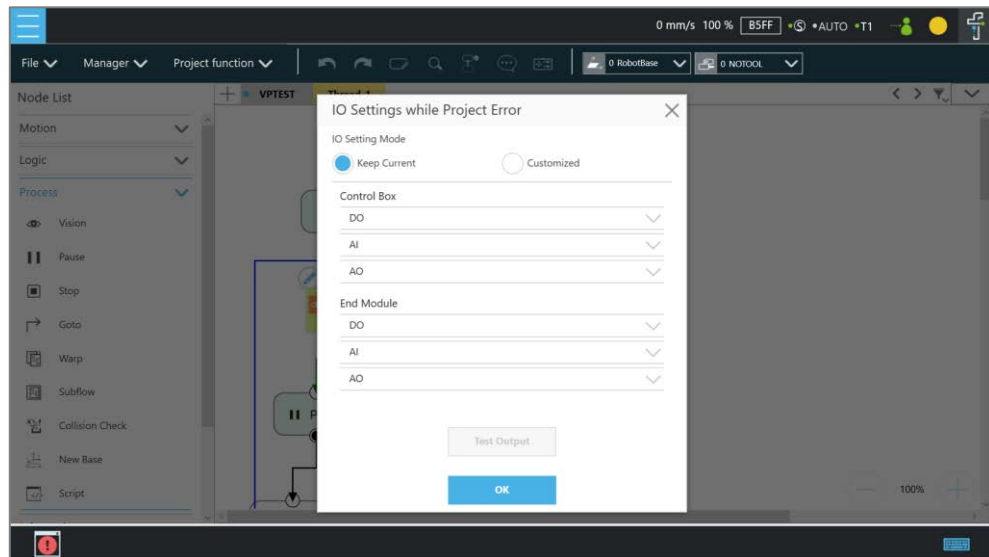

Figure 12 - 7: Status IO Setting

### 1.50 Log Node

The client end can set up the network to create shared folder and communicate with the robot through the LAN. In the project, the set **Variables** and strings can be saved to this shared folder with this Node. The users can use their own computers to view the history messages stored in the **Log** Node in the Shared Folder. As shown in the figure below, the robot motion is programmed in the main flow, and the **Thread** constantly writes its angle information into the text.

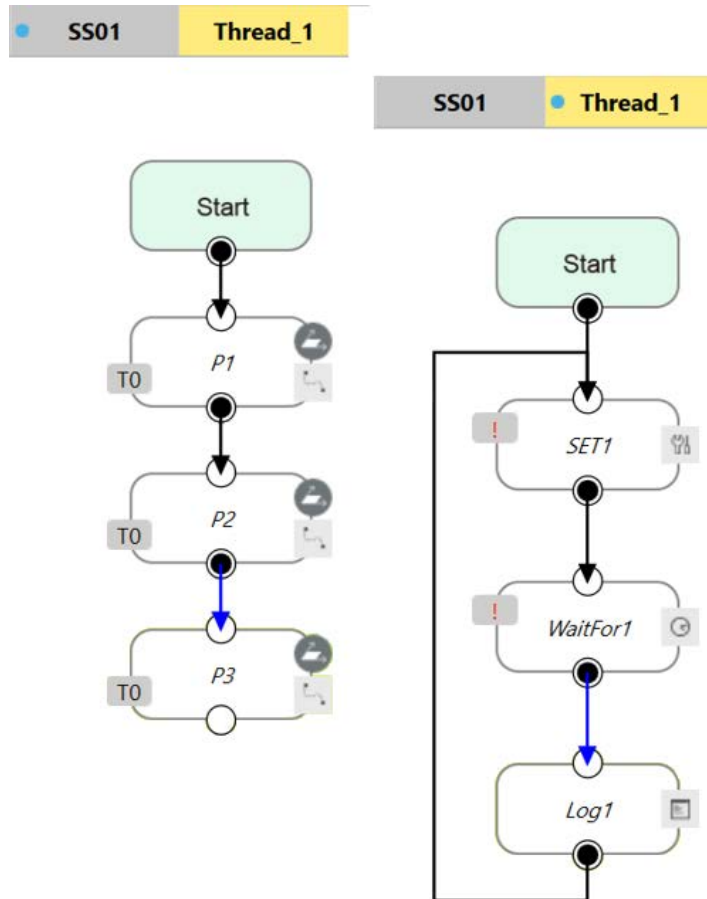

Figure 12 - 8: Log Node Gets the Current Angle

**Note**

**NOTE:**

In the **Content** field of the log node, user can input text or click the **{x}** button to select a variable to apply. The variable list comes with the data type of the variable.

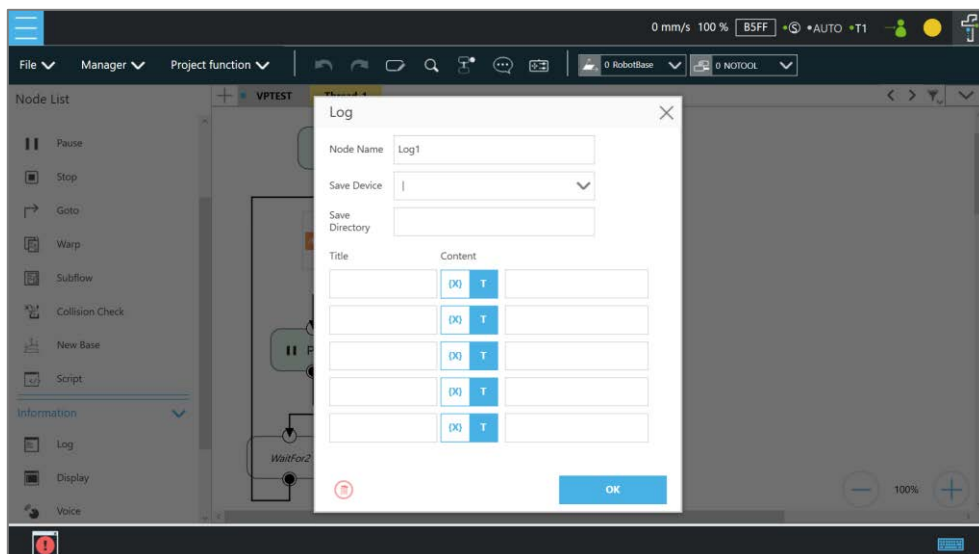

Figure 12 - 9: Log Node Setting

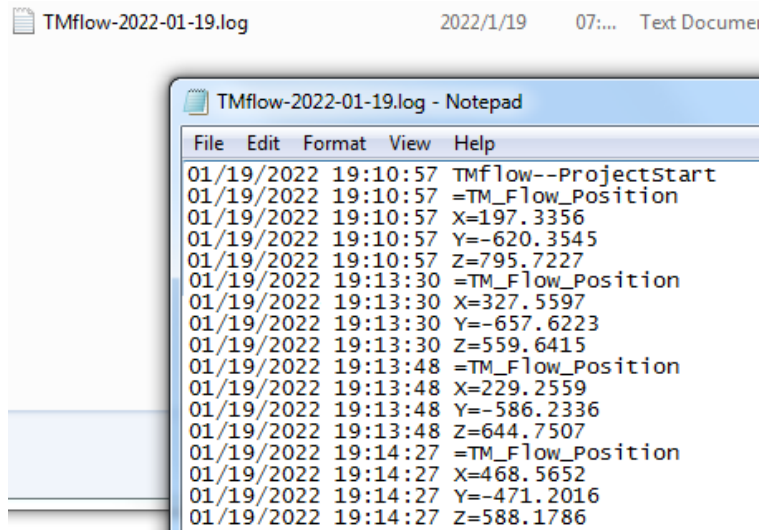

Figure 12 - 10: Node Text Example

### 1.51 Display Node

The function of the **Display** Node is to display the specified variable or string on the screen according to the format specified by users. For example, it can be used to display the state of variables, the value obtained by the serial port, the parameters of the robot, or the results of running. In addition, the **Display** area can change the background color and text color, users can change the color according to the results, and seven colors are supported: red, green, blue, yellow, black, white, and gray.

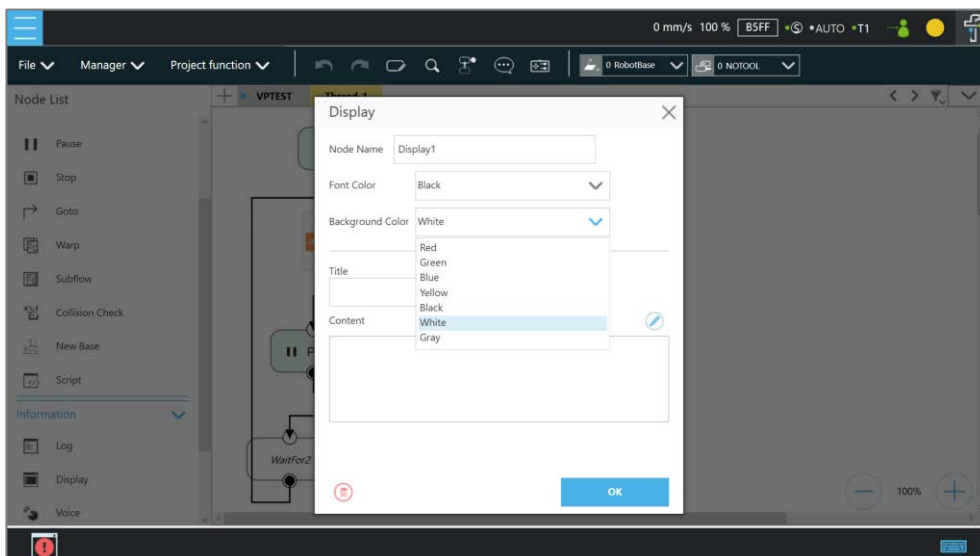

Figure 12 - 11: Display Node Setting

### 1.52 Voice Node

When running through **Voice** Node, the speakers, headphones and other devices can be used to broadcast the set of text or variables. According to different usage, it can be divided into talking while moving (**Speak and Move**), or moving after finishing talking (**Speak, then Move**). The syntax is the same as that of the **Display** Node.

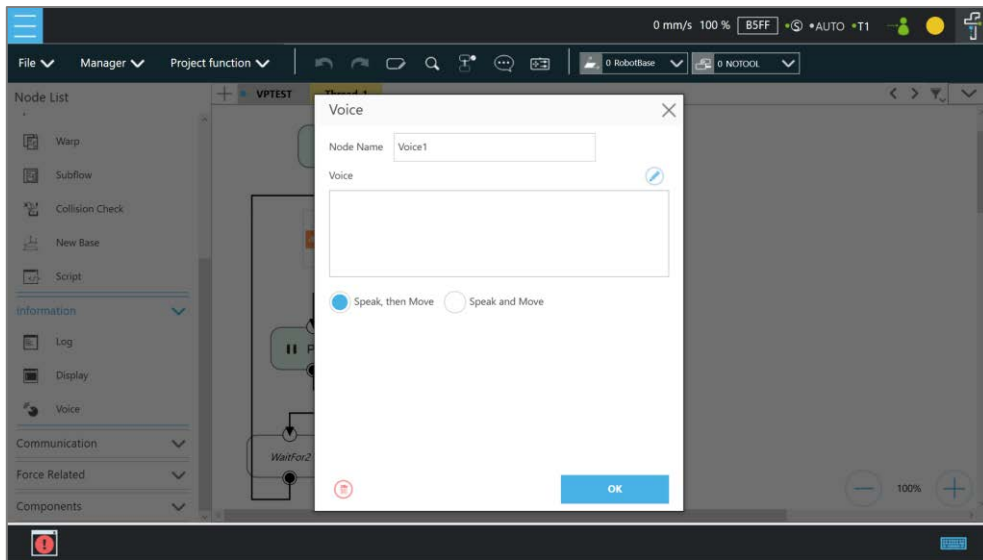

Figure 12 - 12: Voice Node in TMflow Application

For example, users can create a string type variable Hello, and input the combination of **Variable** and string in the **Voice** node. At this time, the external broadcast device will say “Hello World” according to the setting. Be careful that if a space is not added in front of World, then it will become "HelloWorld", and the result with this error will be different from the expected result.



**IMPORTANT:**

If using **Speak and Move**, the speech will be saved into a buffer and deleted only if the system finished speaking it. That means, if the **Voice** is used in a **Thread** with a quick loop, the buffer size will increase rapidly, that the robot might keep speaking without end.

## Component

**Component** is an independent software package for the robot applications. For TM Plug & Play supported items, users do not need to write additional programs or dig into technical documents of both parties before integrating, but import the software package to use in **TMflow** directly. Place the downloaded component in the folder named **TM\_Export** in root directory of a USB drive labeled with **TMROBOT**. Insert the USB drive into to Control Box and navigate to **≡ > System > Import/Export** to import the component onto the robot.

### Note

#### NOTE:

The file path for every type of file that can be Imported/Exported by the TM Robot is as: **TMROBOT:\TM\_Export\RobotName\FileType\FileName\** .

The path names in bold font must follow an exact, case-sensitive naming convention and the others can be named and renamed as users please.

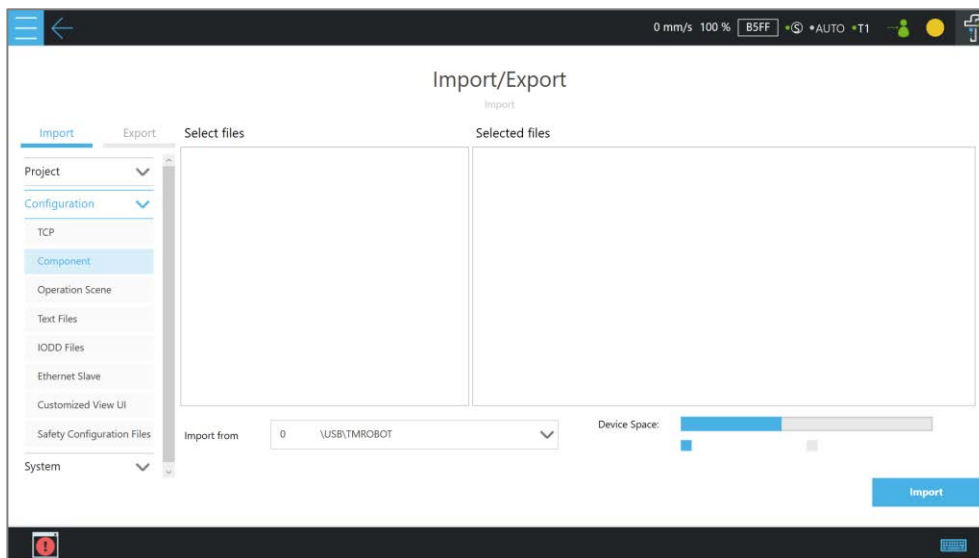

Figure 13 - 1: Select Components

After importing, the software package must be activated in the Component List by navigating to **≡ > Setting > Component** before using. Once activated, the imported software package will be added to the left side of **TMflow**, and users can use it directly by dragged it to the flow.

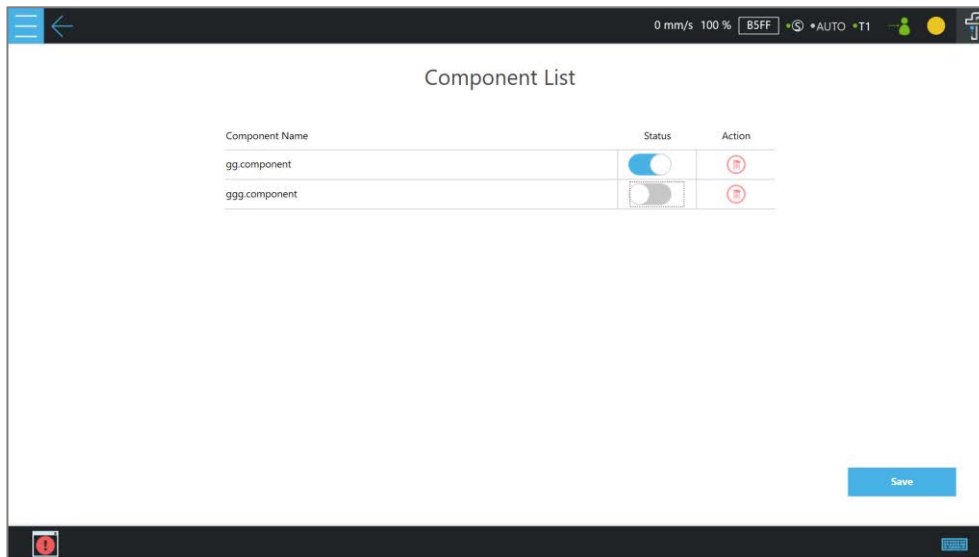

Figure 13 - 2: Component List

The setting parameters of each component are not the same. Refer to 1.61.1 TM Component Editor settings for details.



**IMPORTANT:**

Certain **Components** need to use the **Command** to communicate with the robot. When the certain component is imported, the corresponding **Command** will be added in the **Command** list. Confirm whether the corresponding instruction set is enabled.

TMflow provides a simpler process programming method for the gripper-type software packages. On the **Configuration > End Button** page, click **Gripper Button > Using Customized Component** to set the job triggered by the **Gripper Button** at the **End Module**. The concept is when pressing the **Gripper Button**, a set of **Component** is added in the flow and executed once, and two **Components** are used in sequence (remember that some of the grippers need to be executed with **SET Component** to be applicable). In practical applications, the robot uses the **FREE Button**, working with the buttons of **End Module** record the gripper and point, to complete flow programming without **TMflow** control.



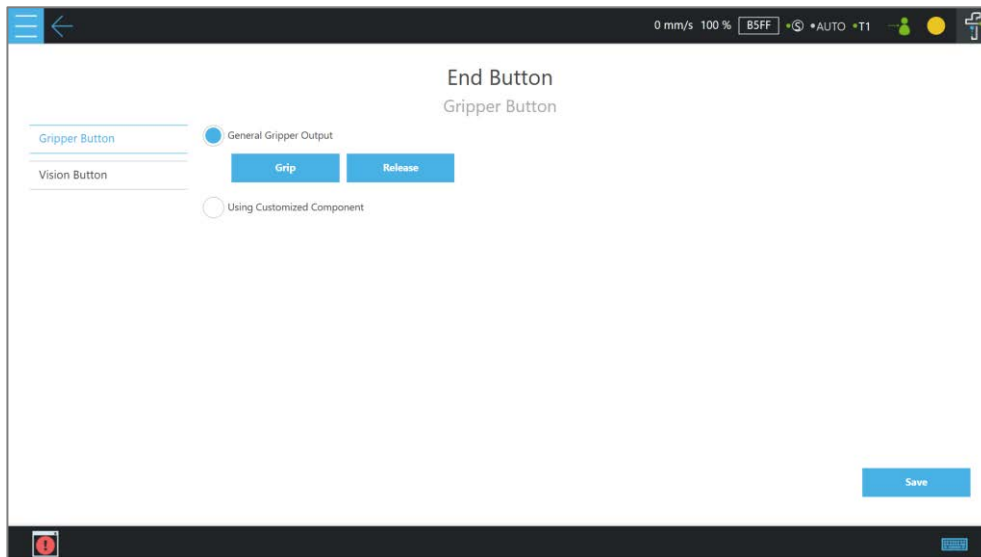

Figure 13 - 3: Gripper Button Setting Page

For making components, refer to 0 TM Component Editor.

## Force Related

This chapter will introduce the force with the TM Robot to conduct more applications such as collision testing, object assembly, object searching, polishing, deburring, inserting, etc. The flow project goes with the F/T sensor device, the touch stop node, the smart-insert node, and the force control node to achieve the force operations. The following will introduce Force Related nodes through the flow project.

### Note

#### NOTE:

Users can set the target force for the robot to operate based on the reference coordinate to. However, the reading of F/T graph and parameterized objects is the force sensed by the F/T sensor concerning the reference coordinate in the nodes. According to the law of action and reaction, the sensor reading will equal to a negative value of the target force for the robot to operate.

### 1.53 Compliance node

The **Compliance** node can set the force limit on the robot movement along a single axis. This setting can be used for various applications of collision testing, object assembly, and object searching. Users can determine the direction of robot motion based on the **Tool** or the **Base**.

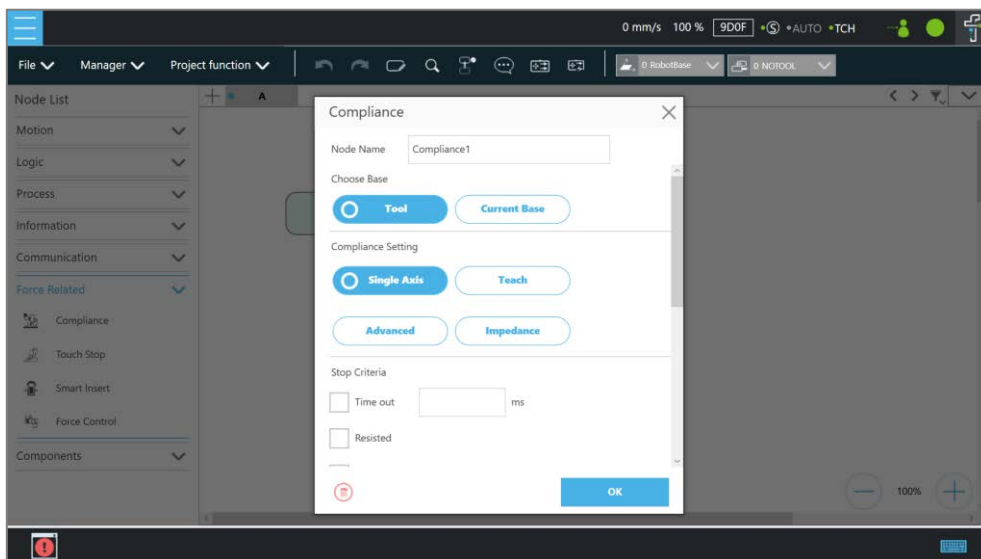

Figure 14 - 1: Compliance Node

- **Choose Base:** Select **Tool** or **Current Base**, and click **OK** to have the robot move accordingly
- **Compliance Setting:** Select **Single Axis** to define the direction (axis), distance, target force/Torque, speed of the compliance.  
**Teach** to use manual teaching method.

**Advanced** to define force/torque, distance limit, and target speed for applicable directions of the compliance.

**Impedance** to set **Stiffness** to have the robot hold its current position but also allow complying with external forces to reduce torque on the joints. It is for use, for example, when mounting the robot on a moving base, such as an AMR, experiences bouncing motions that cause the torque on the joints.

### Single Axis

Direction:	X, Y, Z, Rx, Ry, Rz For (X, Y, Z), the parameters are in (mm, N, mm/s) For (Rx, Ry, Rz), the parameters are in (degree, mNm, degree/s)		
Force limit:	30~150 N	Torque limit:	5000~15000 mNm
Linear speed limit:	30~100 m/s	Angular speed limit:	30~180 degree/s

- **Stop Criteria:**
  - **Timeout:** This node will be released if the set time is reached before or while running the job
  - **Resisted:** When the resistance is sensed, the speed at the robot end is close to zero, and the node is released
  - **Digital Input:** Set a digital input signal to release this node once a specific DI is triggered
  - **Stroke % for DI Detection:** Applicable to **Single Axis** and **Teach**. Detects DI along the moving distance in the single axis. Stops and outputs the variable with Error (6) if DI is detected below the stroke percentage. Stops and outputs the variable with IO Triggered (4) if DI is detected above the stroke percentage.
  - **Analog Input:** Set an analog input signal, when met, this node is released
- **Others**
  - **Output Variable:** An integer to show the result of the Compliance, meaning which criteria are being triggered in the first place, and should have the following possibilities:
    - 2: Timeout
    - 3: Distance Reach
    - 4: Digital Input (or Analog Input) triggered after the Stroke %
    - 5: Resisted
    - 6: ERROR (including TCP speed over limit, incorrect timing of DI triggered, etc.)
    - 14: Over Speed

- **Change payload to:** Define the payload on TCP if any payload existed
- **Compliance Duration when Stop:** Set the length of the time to switch between force control and position control. Defaults to 200, the value is valid between 0 and 1000 as an integer and supports the variable setting.
- **Resistance on non-target motion direction:** Reduce the vibration of the robot. Set to **High Resistance** for applications with great reactions against the robot TCP.
- **Test:** Test the performance. The robot will actually start moving at 3% of project speed when this button is pressed.

The compliance settings of the Node comes with: **Single Axis**, **Teach**, and **Advanced**. Refer to the example description in this Section for single axis. For teaching, the **Compliance** node can choose to teach with line direction or rotation direction. Users can use the two points of teaching to perform relative movement to complete the assembly, collision and other jobs. After setting the relevant parameters, users can specify the speed of motion and other additional stop conditions in the motion mode, to ensure that the tool will not be damaged. In the **Compliance** mode, the safety settings still function.

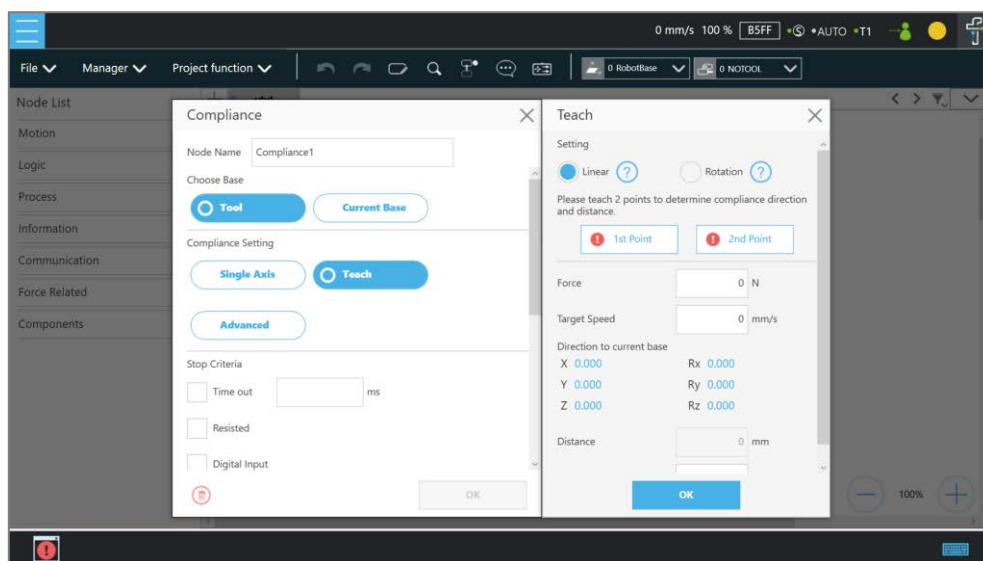

Figure 14 - 2: Compliance Node Teach Setting

- **Teaching setting:** Teach in a line direction or rotation direction. Refer to the figures below for details.
- **Teaching Point:** Set two points and calculate the direction and distance. The two points are not the actual recorded points, and the movement method is relative movement similar to the Move node.

- **Range Adjustment:** Provide Users with direct adjustment of distance or angle in the original direction without resetting the teaching point.

## Linear

Only Linear difference between the 2 teach points is used to perform a relative compliance motion from the point entering the node.

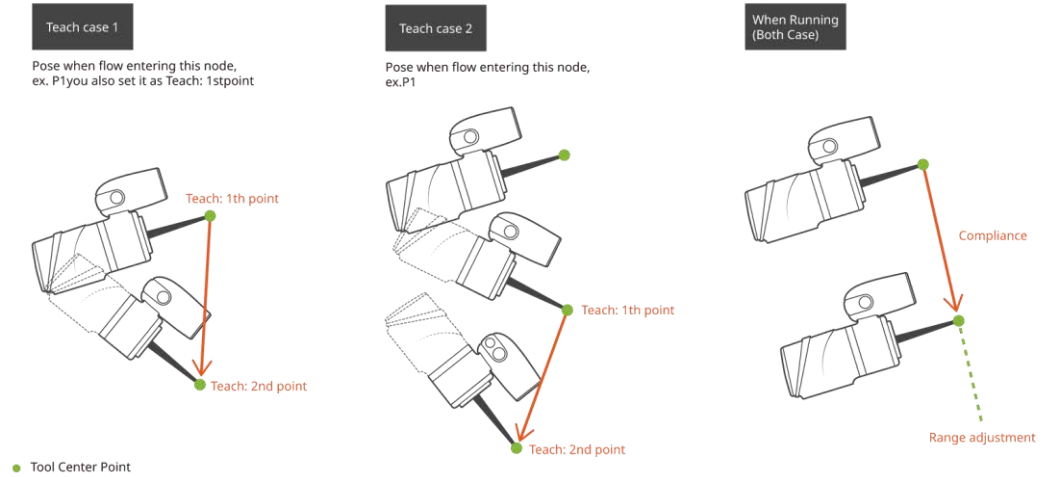

Figure 14 - 3: Line Direction

## Rotation

Only orientation difference between the 2 teach points is used to perform a relative compliance motion from the point entering the node.

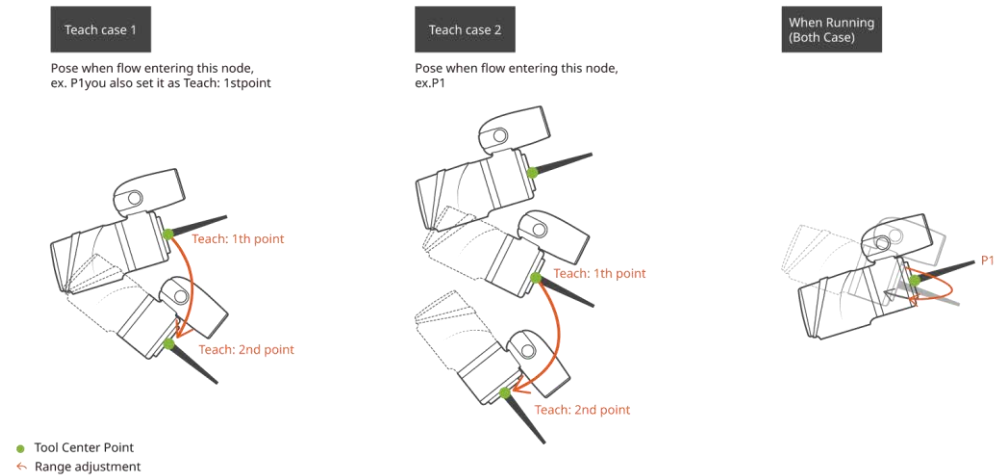

Figure 14 - 4: Rotation Direction

Users can pre-program the solution for any possible situation according to the result of **Variable** returned by the **Compliance** node, and coordinated with the **IF** node.

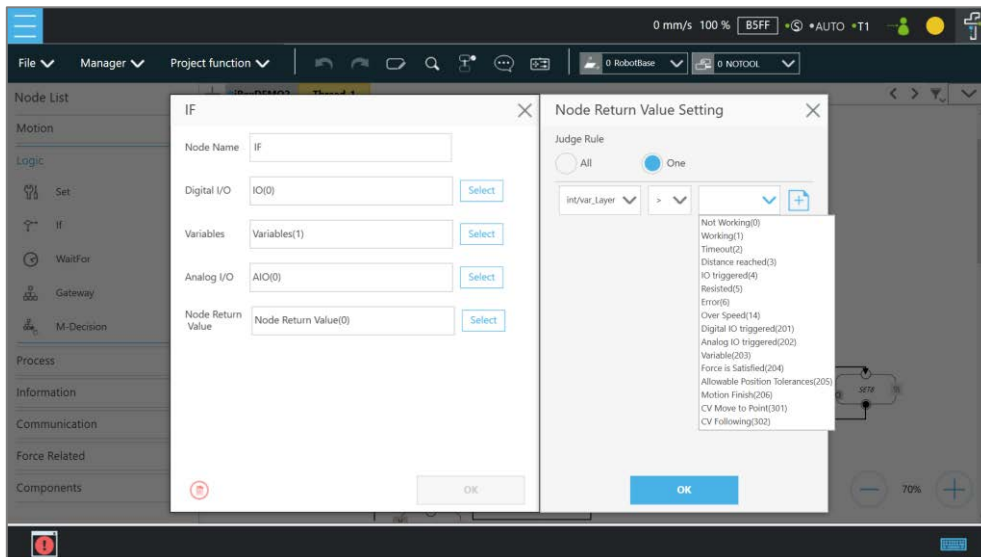
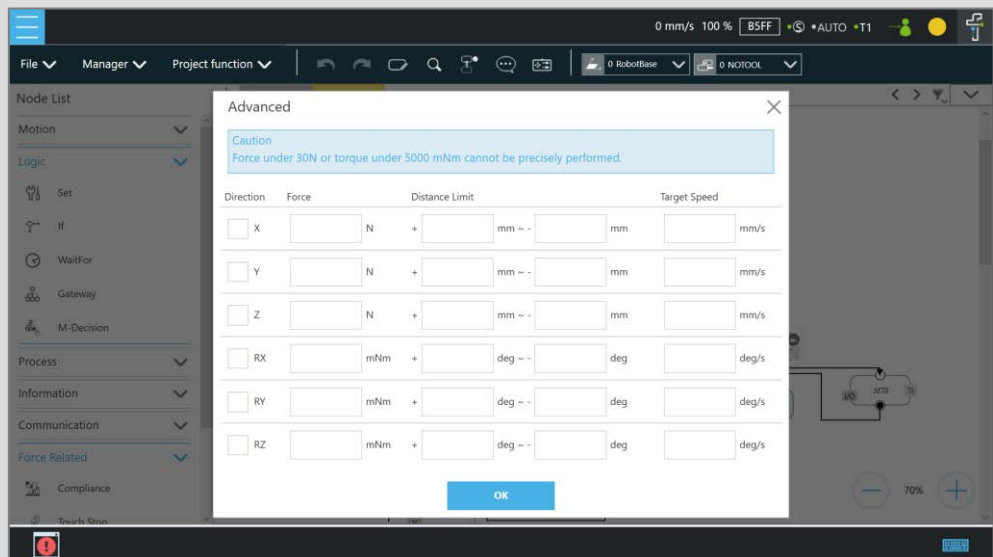

Figure 14 - 5: Compliance Variable Selection

**Note**

**NOTE:**

Users can use **Advanced In Compliance Setting** as a way to edit the force and the torque on each axis in compliance motions without force sensor and to function more practically to setup the application strategy. Users can choose axes as rigid or compliant and decide the target force. **Advanced** is useful for applications with high force/torque tolerances. The minimum force is 30 N, and the minimum torque is 5000 mNm.



**Note**

**NOTE:**

Especially with higher payload and higher reach robots, it is possible that the default force and speed values set in the software will not be sufficient for the Compliance functionality to work accordingly. Users should adjust these values higher as needed to well setup the application.

## 1.54 F/T Sensor

TM Robot integrates F/T sensors from a variety of brands into **TMflow** for users to configure and utilize instantly. At the top left, users can click **Project function > F/T Sensor** to select and configure F/T sensors as shown below.

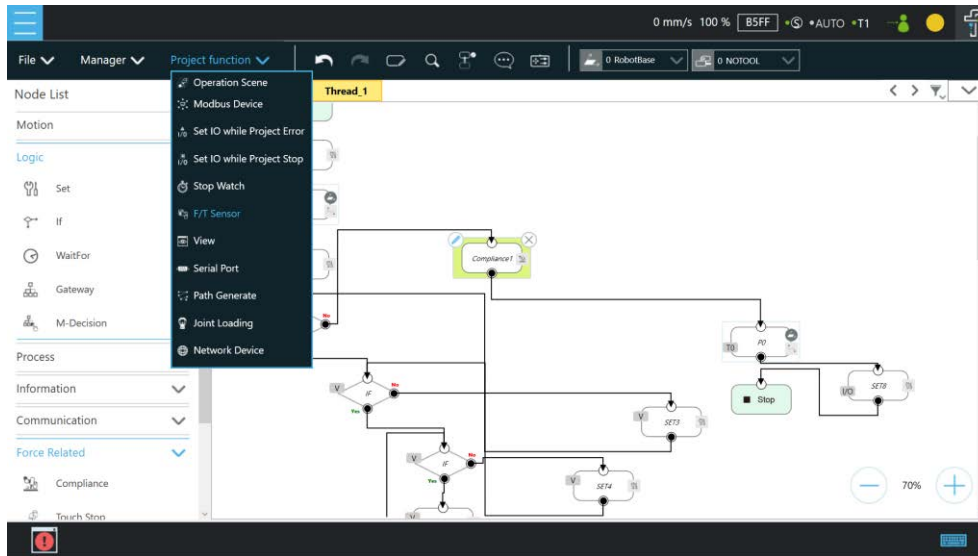

Figure 14 - 6: F/T Sensor

After configuring the **F/T Sensor** communication and position settings, users can use the configured F/T sensor.

### 1.54.1 Communication Setting

Users can configure the model numbers and the communication ports of the TM Robot supported F/T sensors in the communication setting of F/T Sensor.

To configure the communication setting, follow the steps.

1. Click the icon of **F/T sensor**, and click **Add Device**.
2. Select **Communication Setting**.
3. Fill a desired name in the field of **Device Name**.
4. Select **Vendor/Model** and **Com port** of the F/T sensor in the respective dropdowns.
5. Click **OK** when done.

Note

**NOTE:**

Users can fill self-defined names in field of Device Name, select **vendor/Model** of the installed F/T sensor as well as **Com port** that the installed F/T sensor plugged in, and click **OK** to complete the setting. **Baud Rate**, **Data Bit**, **Stop Bit**, and **Parity** are for confirmations only and not configurable by users.

Once the setting is done, users are able to view the configured F/T sensor and values of axes on each direction sensed by the F/T sensor listed in **F/T sensor** as shown.

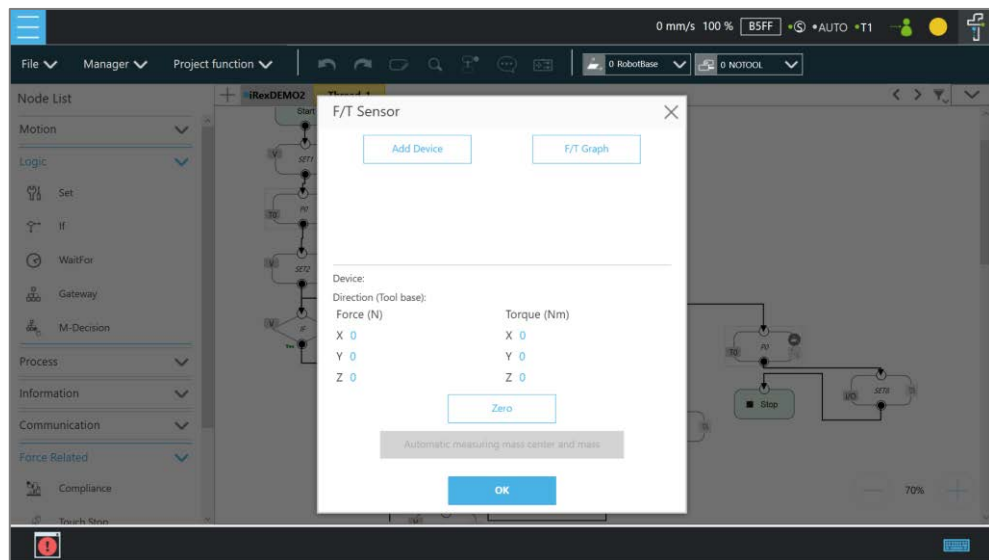

Figure 14 - 7: Read Values after Setting F/T Sensor

Note

**NOTE:**

- Click **Automatic measuring mass center and mass** will generate values in **Tool Gravity Compensation Setting**.
- Script projects do not support **Automatic measuring mass center and mass** in this version.

### 1.54.2 Position Setting

Users can define the position of the F/T sensor to the TM Robot flange in **Position Setting** to convert the coordinates that the F/T sensor measured to the coordinates of the robot flange. The calculation method of the F/T sensor position is as shown in the figure below. Users have to measure the values of X, Y, and Z of the F/T sensor to the TM Robot flange and confirm the rotation angle RX, RY, and RZ based on the angle the F/T sensor installed onto the TM Robot flange.



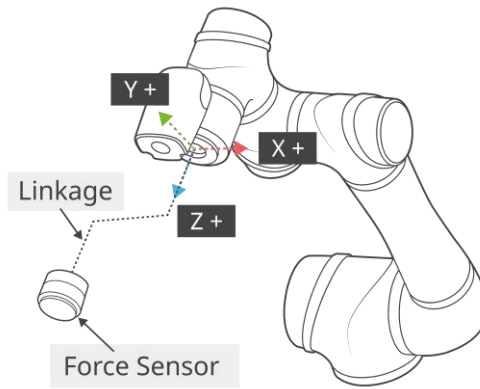

Figure 14 - 8: Position Setting

After confirming the positions and the angles the F/T sensor installed onto the TM Robot flange, users can fill the values of the positions and the angles in **Position Setting** as shown below.

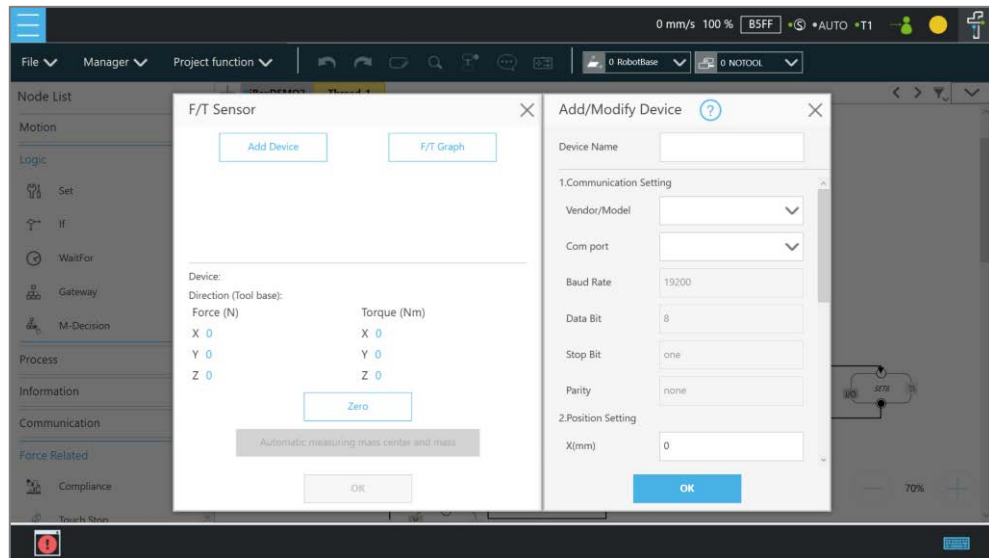

Figure 14 - 9: Select Position Setting

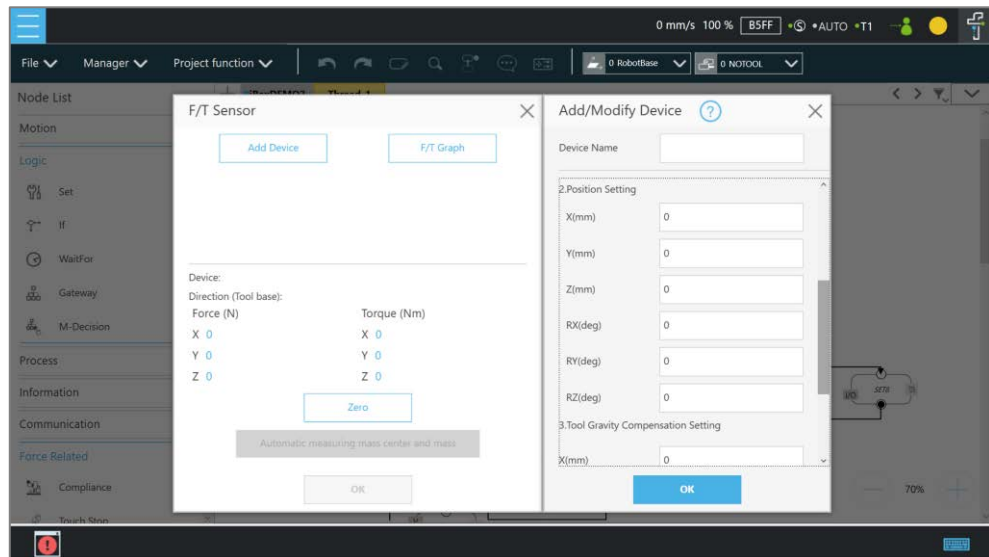

Figure 14 - 10: Input Values

### 1.54.3 Import/Export Settings of F/T Sensor

**TMflow** supports import/export settings of F/T Sensor. Users can export the configured F/T sensor settings and import to the other TM Robots. All users have to do is to export the projects with F/T sensor settings configured and the settings relative to the F/T sensor will be exported along. Refer to 1.28.5 Import/Export for details

### 1.54.4 Force Value and Charts

Once the settings of the F/T sensor are configured, users can observe lines of forces and torques of the F/T sensor in the charts as shown below. Users can also view the fluctuations of forces and torques in the running task while editing in **TMflow**. To show the charts, click the **F/T Graph** button. Click the dropdown next to **Choose Device** for the values read from the sensor or the calculated by the node with the axis and the direction. Check the box before the force or the torque to show the graph on the charts. Check **Auto Scaling** to have the system scale the detected values automatically or set the maximum and the minimum manually.

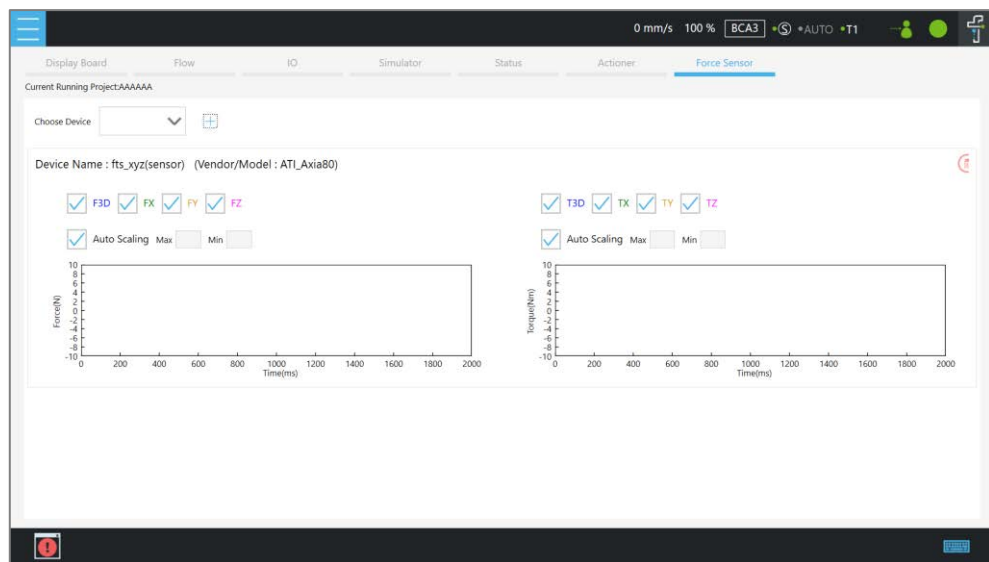
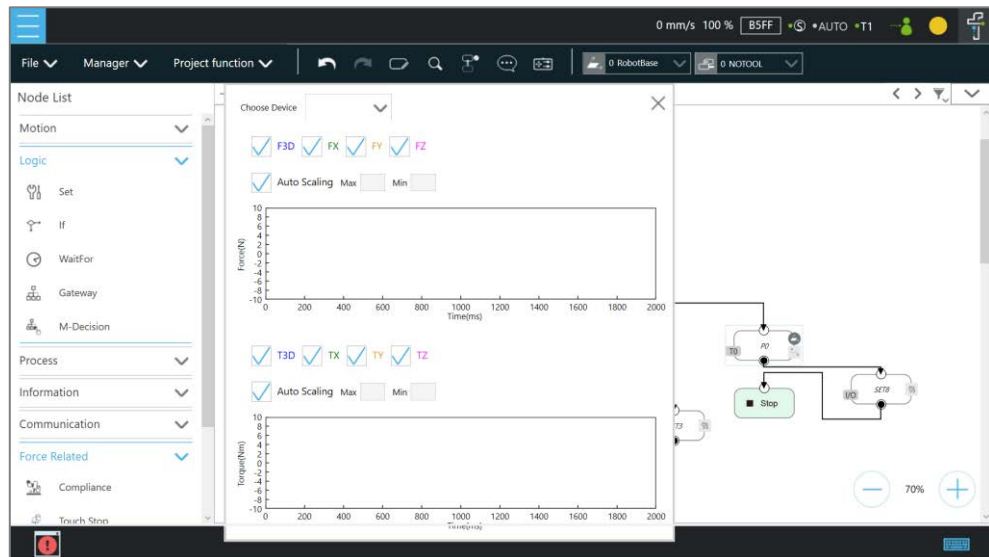

Figure 14 - 11: Charts

**Note**

**NOTE:**

Script projects do not support viewing the force value and charts on the editor page.

The line charts can float on the **Project Page** and show in the **Display Board**.

**Note**

**NOTE:**

F3D and T3D represent resultant force and resultant torque respectively, namely that

$$F3D = \sqrt{F_x^2 + F_y^2 + F_z^2} \quad T3D = \sqrt{T_x^2 + T_y^2 + T_z^2}$$

1.55 Touch Stop Node

The **Touch Stop** node comes with three function types: **Compliance**, **Line**, and **Force Sensor**.

### 1.55.1 Function Type: Compliance

Capable of setting the force limit when the robot moves along a single **Base**, this setting can be used for various applications of object searching, creating a new **Base**, and recording the current coordinate value of triggering **Touch Stop**.

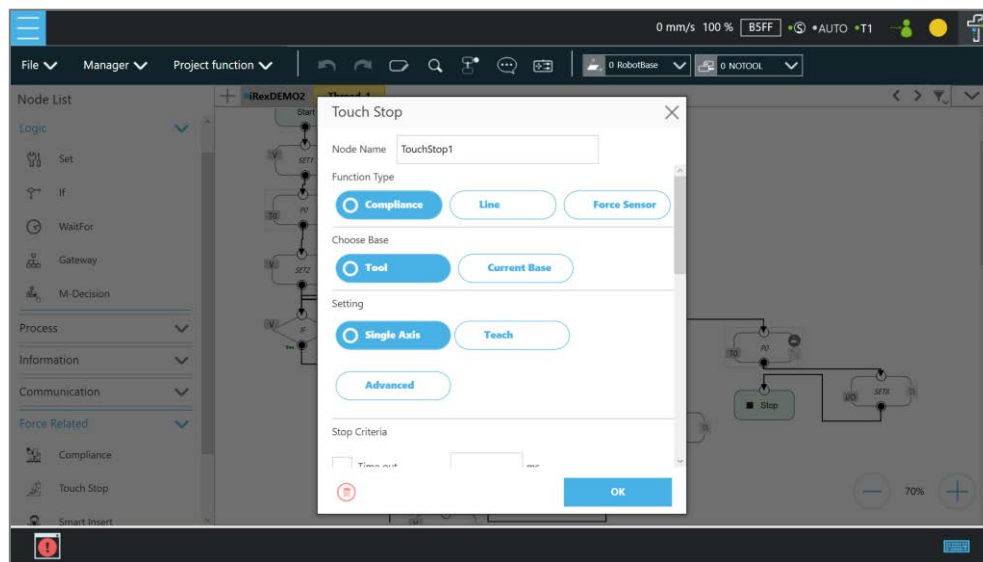

Figure 14 - 12: Touch Stop-Compliance Settings

- **Choose Base:** Select **Tool** or **Current Base**, and click **OK** to have the robot move accordingly.
- **Setting:** Select **Single Axis** to define the direction (axis), distance, target force/Torque, speed of the compliance, **Teach** to use manual teaching method, or **Advanced** to define force/torque, distance limit, and target speed for applicable directions of compliance.
- **Stop Criteria:**
  - **Timeout:** Set the length of time to stop and release this node
  - **Resisted:** When the resistance is sensed, the speed at the robot end is close to zero, and the node is released
  - **Variable:** Set rules to determine variables
  - **Digital Input:** Set a digital input signal to release this node once a specific DI is triggered
  - **Stroke % for DI Detection:** Applicable to **Single Axis** and **Teach**. Detects DI along the moving distance in the single axis. Stops and outputs the variable with Error (6) if DI is detected below the stroke percentage. Stops and outputs the variable with IO Triggered

(4) if DI is detected above the stroke percentage.

- **Analog Input:** Set an analog input signal that, when met, the node is released.
- **Others:**
  - **Output Variable:** An integer to show the result of the Compliance, meaning which criteria are being triggered in the first place, and should have the following possibilities:
    - 2: Timeout
    - 3: Distance Reach
    - 4: Digital Input (or Analog Input) triggered after the Stroke %
    - 5: Resisted
    - 6: ERROR (including TCP speed over limit, incorrect timing of DI triggered, etc.)
    - 14: Over Speed
    - 203: Variable
  - **Change payload to:** If equipped, set the weight of the device at the end of the robot in kilogram.
  - **Compliance Duration when Stop:** Set the length of time to switch between force control and position control. Defaults to 200 ms, the value is valid between 0 and 1000 ms as an integer and supports the variable setting.
  - **Resistance on non-target motion direction:** Reduce the vibration of the robot. Set to **High Resistance** for applications with great reactions against the robot TCP.
- **Record Stopping Position on POINT:** Select from the **Stopping position** or the **Triggered position** and fill the name in the field below to record the robot position at the time being as a dynamic point when the robot puts on the brake. The dynamic point will be in **Point Manager** when you have:
  - ◆ clicked **Test**
  - ◆ clicked **OK** or **run/Step Run** the flow
- **Test:** Test the performance. The robot will actually start moving at 3% of project speed when this button is pressed.

Note

**NOTE:**

On all stop criteria, the **Touch Stop** points recorded to Modbus devices. Refer to Appendix C: Modbus List for details.

### 1.55.2 Function Type: Line

This function is designed to set the robot's line movement along a **Single Axis**, or direction **Teach**, and works with the external signals to stop the robot motion. This setting can be used for

sensors on external tools to record the position. Users can determine the direction of robot motion based on the **Tool** or the **base**.

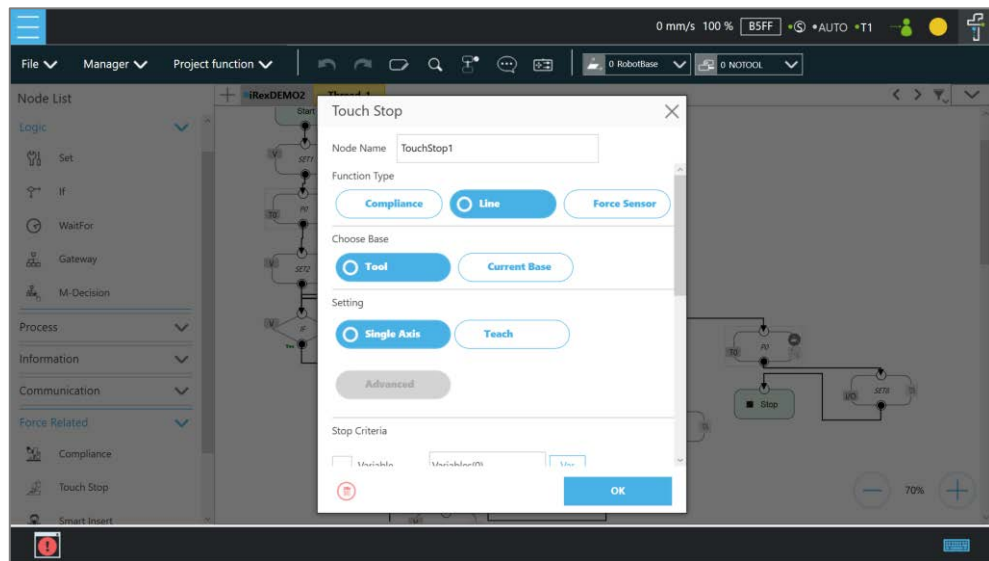

Figure 14 - 13: Touch Stop-Line Settings

- **Choose Base:** Select **Tool** or **Current Base**, and click **OK** to have the robot move accordingly
- **Setting:** Set the robot to move along the direction of a single axis or teach using manual teaching. Check the box next to **Link to project speed** to align the speed with the project speed.
- **Stop Criteria:**
  - **Variable:** Set rules to judge from the outcomes of variables in expressions
  - **Digital Input:** Set a digital Input signal to release this node once a specific DI is triggered
  - **Analog Input:** Set an analog input signal that, when met, the node is released.
- **Others:**
  - **Output Variable:** An integer to show the result of the Compliance, meaning which criteria are being triggered in the first place, and should have the following possibilities:
    - 3 Distance Reach
    - 201 Digital Input
    - 202 Analog Input
    - 203 Variable
  - **Braking distance:** Set the distance available from 0 to 125 mm for the robot putting the brake on digital input or analog input. The maximum distance available is 125 mm. An

input value larger than 125 will give an error message.

- **Change payload to:** If equipped, set the weight of the device at the end of the robot in kilograms.
- **Record Stopping Position on POINT:** Select from the **Stopping position** or the **Triggered position** and enter the name in the field below to record the robot position, as a dynamic point, at the time when the robot puts on the brake. The dynamic point will be in **Point Manager** when you have:
  - ◆ clicked **Test**
  - ◆ clicked **OK** and **Run/Step Run** the flow
- **Test:** Test the performance. The robot will actually start moving at 3% of project speed when this button is pressed.

### 1.55.3 Touch Stop Function Type: Force Sensor

Of the three function types in a **Touch Stop** node, **Force Sensor** is the only one that uses the force sensor to proceed with the force touch stop measurement. Once configured, users can select **Force Sensor** to assign the desired device as shown below, and use the device to measure the sensed force along the named directions.

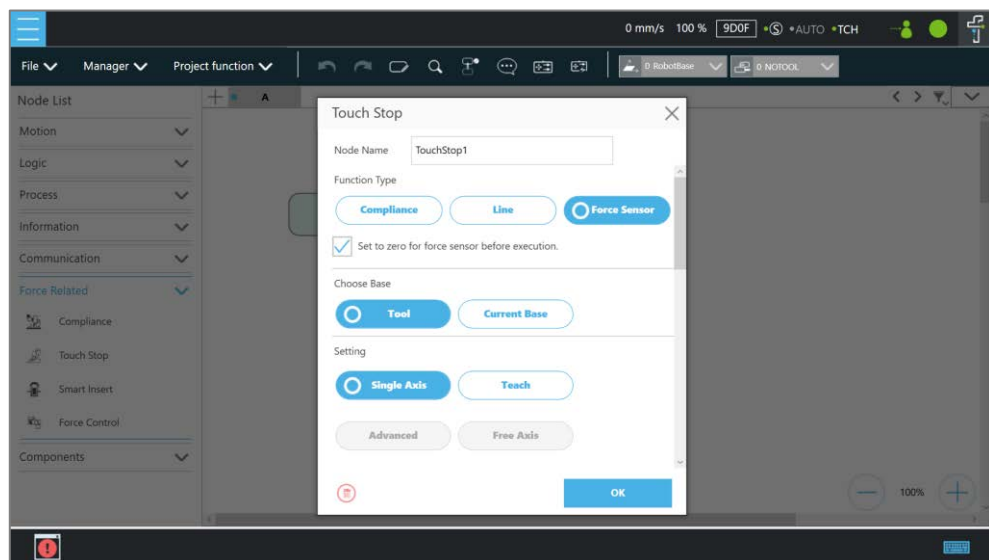

Figure 14 - 14: Touch Stop-Force Sensor

To select a configured force sensor, follow these steps.

1. Click the pencil icon of the **Touch Stop** node.
2. Click the **Force sensor** button in **Function Type**.
3. Click the box next to **Choose device** to select from the list of the configured force sensors.

4. Click **OK** when done.
- **Set to zero for force sensor before execution:** For more precise measured values while running force tasks, users can check this feature before running force tasks. This feature sets zero to every current axis value of the force sensor, so the returned force values reflect the real force in the force tasks. During the force sensor zero-out process, ensure that the force sensor is not in contact with any object to avoid additional external forces that may affect the measurement results of the force sensor.
  - **Choose Base:** Select **Tool** or **Current Base**, and click **OK** to have the robot move accordingly.
  - **Setting:** Set the robot to move along the direction of a single axis, teach using manual teaching.
  - **Stop Criteria:**
    - **Force Reached:** There are three type of force reached to choose: **Force**, **F3D**, and **T3D** as shown below.

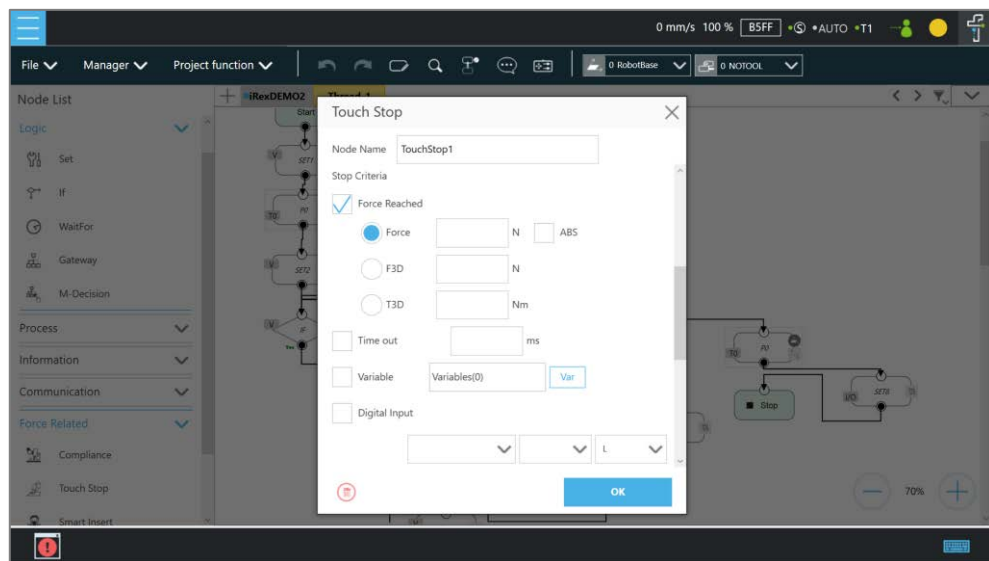

Figure 14 - 15: Force Sensor

**Note**

**NOTE:**

Force will change the measurement unit based on users' setting in Single Axis. In other words, if users set **Direction** to Rx, Ry, or Rz, the measurement unit will change from N to Nm. Force/Torque monitors the forces/torques along the named directions. Once it reaches the preset values of the forces/torques, the robot stops the detection movement to proceed with the next assigned movement, namely that forces/torques along the other directions but not the named directions will not fulfill the stop criteria of the **Touch Stop** node while the project is in progress.



- **Timeout:** Set the length of time to stop and release this node
- **Variable:** Set rules to judge from the outcomes of variables in expressions
- **Digital Input:** Set a digital Input signal to release this node once a specific DI is triggered
- **Analog Input:** Set an analog input signal that, when met, the node is released.
- Others:
  - **Output Variable:** An integer to show the result of the Compliance, meaning which criteria are being triggered in the first place, and should have the following possibilities:
    - 2 Timeout
    - 3 Distance Reach
    - 6 ERROR (including TCP speed over limit, incorrect timing of DI triggered, etc.)
    - 201 Digital Input
    - 202 Analog Input
    - 203 Variable
    - 204 Force Satisfied
  - **Change payload to:** If equipped, set the weight of the device at the end of the robot in kilograms.

Note

**NOTE:**

Force and torque will be obtained when the tool of the robot collides with environment. The reaction force/torque will also operate at robot. If the robot switches to position control, the robot might generate a safety alarm due to reaction force/torque. In order to avoid the error safety alarm, the **Touch Stop** node will turn control mode to **Compliance** when force/torque reaches users' stop criteria. Users can set payload which is the weight from the robot flange to the end of the tool for having better **Compliance** operation.

- **Compliance Duration when Stop:** Set the length of the time to switch between force control and position control. Defaults to 200 ms, the value is valid between 0 and 1000 ms as an integer and supports the variable setting.
- **Record Stopping Position on POINT:** Select from the **Stopping position** or the **Triggered position** and enter the name in the field below to record the robot position, as a dynamic point, at the time when the robot puts on the brake. The dynamic point will be in **Point Manager** when you have:
  - ◆ clicked **Test**
  - ◆ clicked **OK** and **Run/Step Run** the flow

- **Test:** Test the performance. The robot will actually start moving at 3% of project speed when this button is pressed.



**NOTE:**

The system will report an error and light in red if no device is in the node setting.

### 1.56 Smart Insert Node

The **Smart Insert** Node allows the robot to perform assembly/pushing jobs. The smart design enables difficult object assembly/pushing jobs to be completed through simple and quick setting. The inserting action of **Smart Insert** Node can be divided into three steps: **Approaching**, **Searching**, and **Pushing**. This Node needs to be worked with the cooperating force sensor in TM Plug & Play for use. The following describes the three steps of pushing.



**NOTE:**

It is required to set the tool coordinate in the same direction as the installation direction of the force sensor, or it will result in misjudgment of the contact force. If it is not possible to set so, instead use the force control node to measure the contact force of the inserting object rather than use the smart insert node.

#### 1.56.1 Approaching

##### 1.56.1.1 Approaching principle description

Before using the **Smart Insert** node, users should place the inserting object as close to the assembly as possible. In the **Approaching** step, the robot will move in the z axis direction of the **Tool Coordinate** until the force sensor detects 5 Newtons (N).

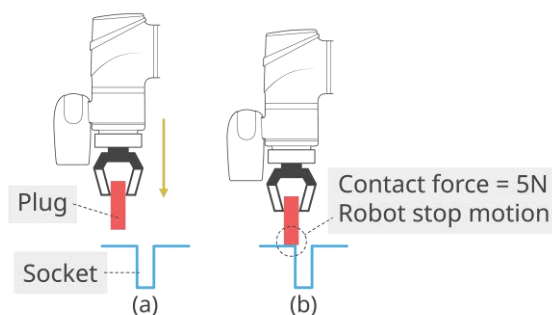

Figure 14 - 16: Approaching Principle

(a) Try to position the robot as close to the socket as possible

(b) When the contact force is 5 Newtons, the robot ends **Approaching**



**IMPORTANT:**

Since the contact force needs to reach 5 Newtons, for the **Approaching** step to end, users need to confirm that the socket and object to be inserted are able to withstand at least 5 Newtons of force, so as not to damage the product.

### 1.56.1.2 Approaching parameters setting

The **Approaching** of the **Smart Insert Node** provides three setting parameters:

- **Approaching Speed** : 0.5 to 10 mm/s
- **Moving Distance Limit** : 1 to 100 mm
- **Time Out** : 1 to 20 s

Note that the approaching direction of the **Smart Insert Node** is the Z axis direction of the Tool Coordinate.

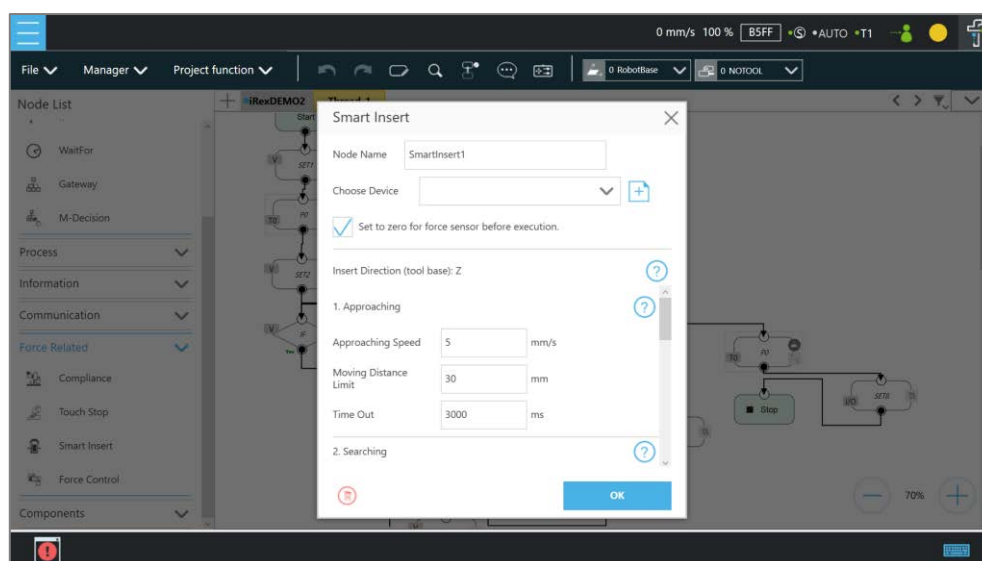

Figure 14 - 17: Approaching Parameter Setting

### 1.56.2 Searching

After ending **Approaching**, the robot switches to **Searching**. **Searching** can be divided into two strategies: **Spiral** and **Linear**. The figure below is the motion method of the **Spiral** strategy. This searching strategy uses the **Approaching** contact point as the center of the spiral, and searches outward in a spiral motion until the stop condition is met. If users select **Linear** for searching, the robot will follow the selected axis to perform **Line** search until the stop condition is met, as

shown in the figure. Regardless of **Spiral** or **Linear**, the robot exerts the **Contact Force** as a constant downward force in the Tool Z-axis direction during searching.

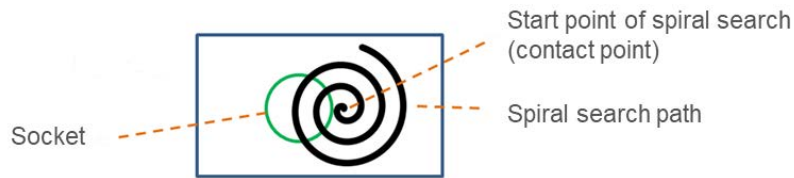

Figure 14 - 18: Spiral Searching Method

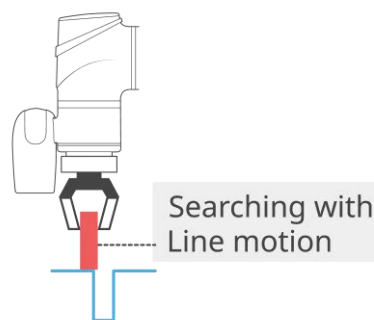

Figure 14 - 19: Line Searching Method (1/2)

The stop criteria of **Searching** comes with **Completed Searching** and **Stop Searching**. If the plug enters the socket, the combined force of X-Y Plane will be greater than 5 Newtons (N), and the contact force on the z-axis equals 0. This is judged as **Completed Searching** and goes to the final stage of **Inserting**. **Stop Searching** is determined by the robot being unable to find the socket within the search conditions, such as the searching time or distance being too long.

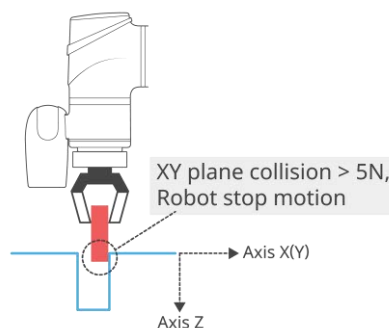

Figure 14 - 20: Line Searching Method (2/2)

When the XY combined force of collision is greater than 5 Newtons, it is judged as **Completed**

## Searching.

### 1.56.2.1 Method for searching: Spiral

In **Spiral** searching, the **Searching Radius**, **Circling Frequency or Tangential Speed**, **Height Tolerance**, and **Time Out** need to be set. These parameters are shown in the Table below.

Terminology		Definition	Setting Range
<b>Contact Force</b>		Maximum force allowed in the tool searching direction.	5~10 N
<b>Searching Radius</b>		Maximum radius of spiral searching motion	1~30 mm
<b>Circling</b>	<b>Frequency</b>	Number of circles per second	0.5~1.5 Hz
	<b>Tangential Speed</b>	Speed of circling per second	1~90 mm/s
<b>Height Tolerance</b>		Maximum height of the robot in Tool Coordinate Z axis	1~100 mm
<b>Timeout</b>		Maximum searching time	1000~20000 ms

Table 17: Spiral Searching Function Setting Parameters Definition

Note that during the spiral searching process, the robot may move out of the boundary of the socket, and misjudge it as **Inserting Point Found**. Setting a **Height Tolerance** can prevent this from occurring.



#### **NOTE:**

In general, if the geometry shape of the inserting object is circular, such as positioning pins, it is recommended to use the spiral searching method; if the geometry shape of the insert object is rectangular, it is recommended to set the searching method to **Linear**.

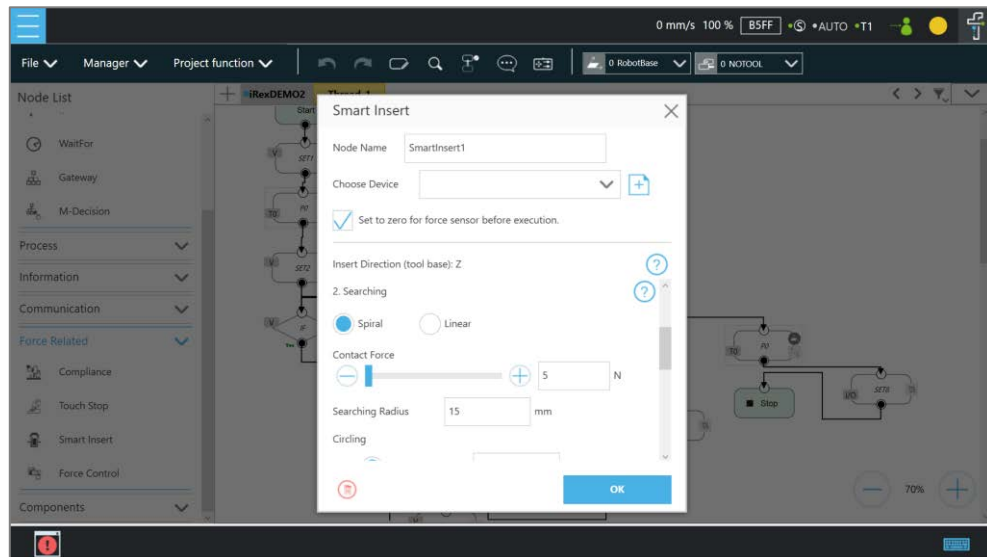

Figure 14 - 21: Spiral Searching Parameter Setting Interface

#### 1.56.2.2 Method for searching: Linear

Different from the **Spiral** searching, the **Linear** searching can set the power of the Tool Coordinate Z axis contact force and the **Linear** searching direction (**Searching Direction**). The **Linear** searching parameters are defined as shown in the Table below.

Terminology	Definition	Setting Range
<b>Contact Force</b>	Maximum force allowed in the tool searching direction.	5~10N
<b>Searching Direction</b>	Select Tool Coordinate X, Y, -X, or -Y axis search direction	-----
<b>Searching Speed</b>	Speed of linear searching	0.5-10 mm/s
<b>Maximum searching distance</b>	Maximum distance to search	1-100 mm
<b>Timeout</b>	Maximum Searching Time	1000~20000 ms

Table 18: Linear Searching Function Setting Parameter Definition

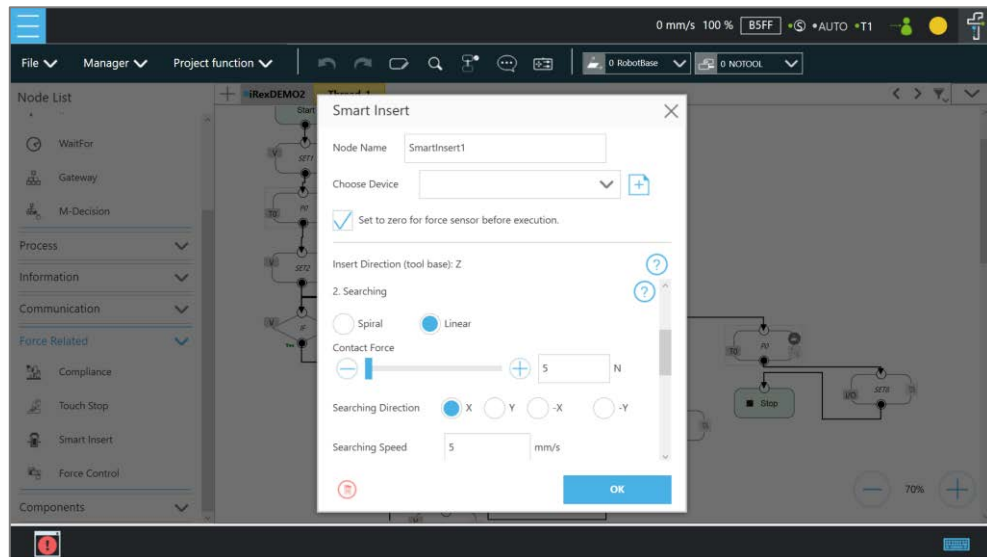

Figure 14 - 22: Linear Searching Parameter Setting Interface

### 1.56.3 Pushing

After completing steps in **Searching**, the plug has been aligned with the socket. During **Pushing**, the robot will move in the Z-axis direction until the stop condition is reached, such as detecting the Z-axis contact force or the stroke distance. If X, Y, RX, RY, and RZ detect external force resistance, the **Smart Insert** node will automatically move smoothly in the opposite direction of the collision to avoid causing interference during pushing.

#### 1.56.3.1 Parameter Setting

Parameter setting of **Pushing** is similar to the **Linear Searching**. Users can set the **Contact Force**, **Pushing Speed**, **Moving Distance Limit** and **Time Out** of the **Pushing** process.

The definition and setting of each parameter is shown in the Table below.

Terminology	Definition	Setting Range
<b>Contact Force</b>	Tool Coordinate Z-axis contact force	5-150N
<b>Pushing Speed</b>	Moving speed of linear pushing	0.5-10 mm/s
<b>Moving distance Limit</b>	Maximum moving distance	1-100 mm
<b>Timeout</b>	Maximum searching time	1-20sec

Table 19: Pushing Parameter Definitions

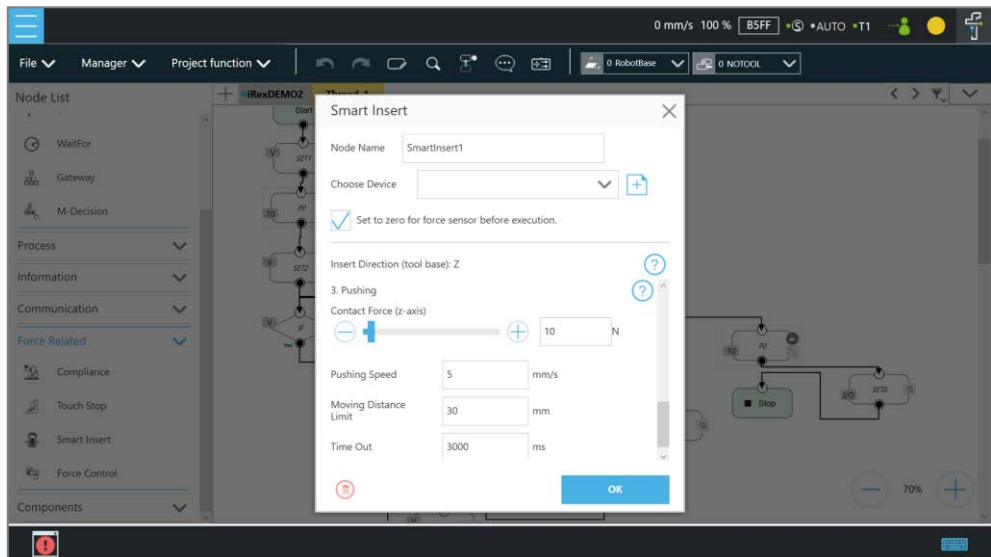

Figure 14 - 23: Pushing Parameter Interface



**NOTE:**

The system will report an error and light in red if no device is in the node setting.

1.57 Force Control Node

The **Force Control** node comes with three reference coordinates and two operation modes for applications such as polishing, grinding, and deburring.

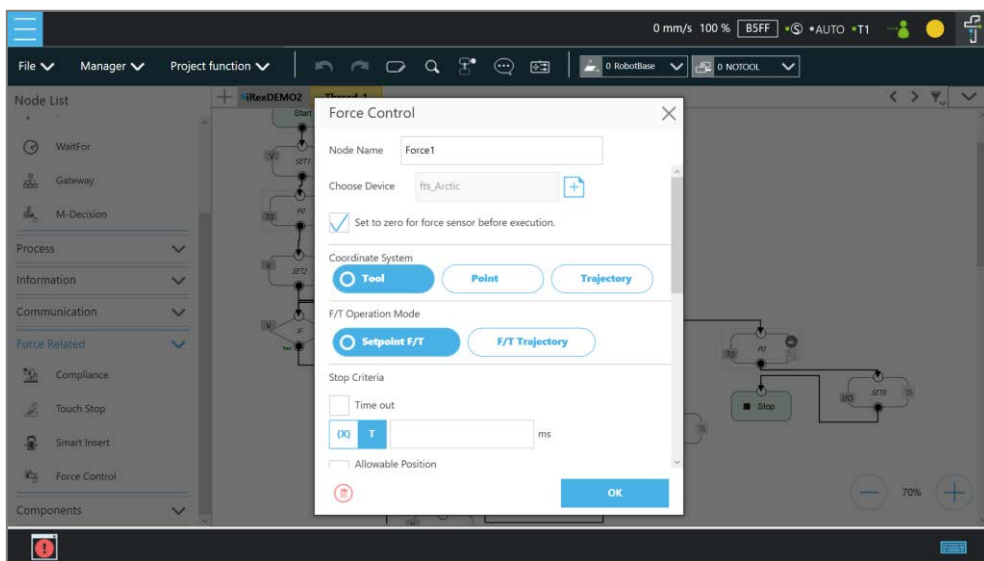

Figure 14 - 24: Force Control Node Settings

- **Choose device:** Select a configured force sensor from the list





- **Trajectory:** The coordinate of FT sensor changes along with the path (speed tangent direction).

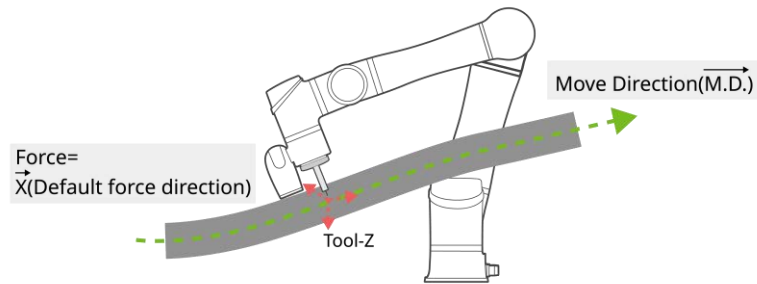

$$\begin{aligned} \vec{X} &: = \overline{M.D.} \times \overline{Tool(Z)} \quad (\text{Tool}(z) \text{ can't be parallel with } \overline{M.D.}) \\ \vec{Z} &: = \vec{X} \times \overline{M.D.} \\ \vec{Y} &: = \overline{M.D.} \end{aligned}$$

Figure 14 - 27: Trajectory Coordinate System

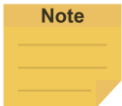

**NOTE:**

1. The direction of the trajectory movement cannot be parallel to the **TCP** of Tool Z.
2. When the **TCP** of the robot does not have the XYZ direction speed at two consecutive machining points as shown in the figure below, the force sensor coordinate system may be incorrectly operated and resulting in unexpected results. It is recommended to change the machining path or select **Tool** or **Base** as the reference coordinate system.

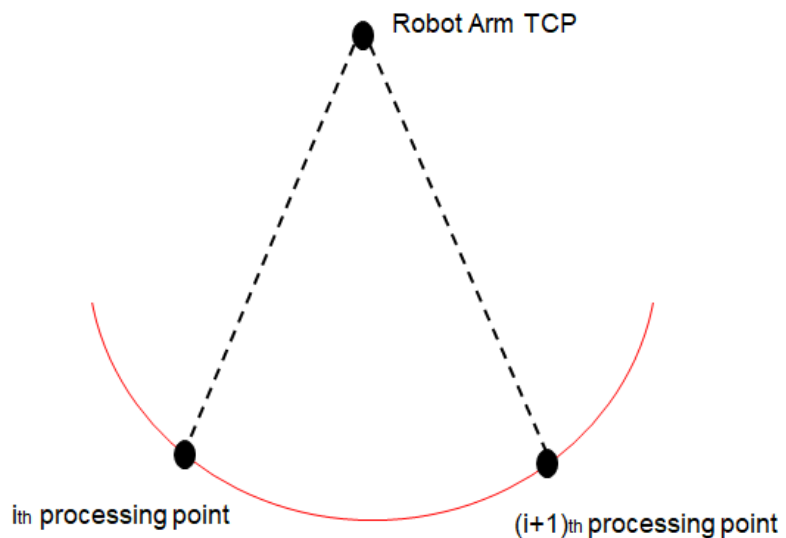



Figure 14 - 28: Possible Conversion Error

The two consecutive processing points on the TCP position of the robot, if in

fixed-point motion, may cause the force sensor coordinate system conversion error.

- **F/T Operation Modes**

Select from two of the F/T operation modes.

- **Setpoint:** Use Setpoint to set the XYZ axial force and the Rx, Ry, and RZ axial moments as required as shown in the figure below. The positive and negative values set represent the direction of force control. Users can click  to select a variable as a value to apply. In the axial PID values of the force control, the parameters of the five sets of PIDs are provided from weak to strong. Users can click the **Advanced** button to set the PID values according to each axial force control and click  to select a variable as a value to apply.

To have the robot perform force control in a known safe space, users can set the range of the robot movement. The system will move the robot in a cube with the length in accordance with the set value. The available range is 0~4000mm.

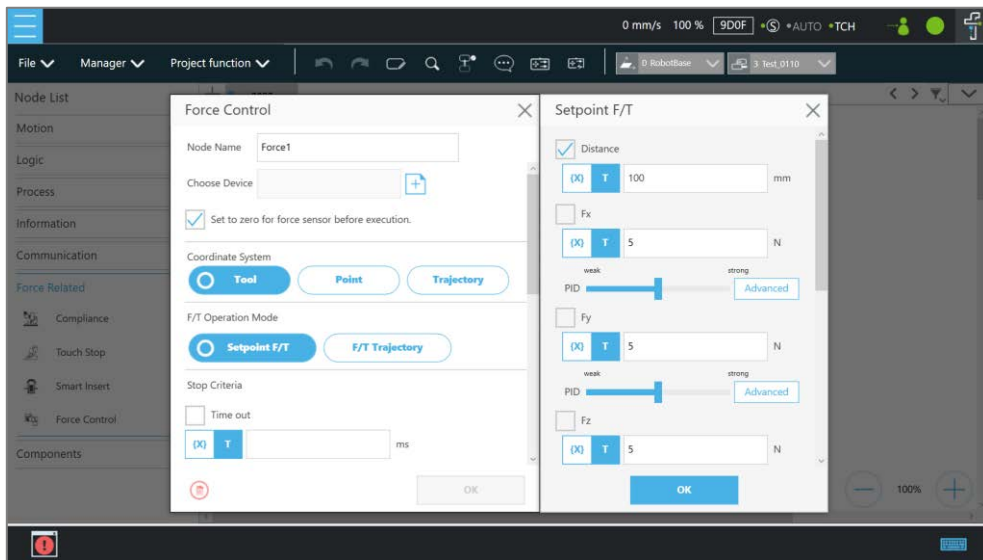

Figure 14 - 29: F/T Operation Modes – Setpoint

**Note**

**NOTE:**

Users can adjust PID values for specific applications. However, self-adjusting the PID parameters may cause the robot to control the divergence and cause vibrations or errors. For the Kd (Derivative gain) value, the suggested initial value of adjustment is 0.001. During the adjustment, a joint error may occur for generating large deviation in the control

command sent to the joint (e.g. error code 0x0005FFCB). To recover from the error, press and release the **Emergency Switch** of the **Robot Stick** to safely start up again.

- **Trajectory:** When the robot task needs to follow a specific machining path and maintain the force control while moving along the path, the operation mode **Trajectory** can be selected. The force/torque, PID settings, and speed limits for each axis are the same as **Setpoint**. To import the movement path of the force control, users can add or select **Subflow** in the **Choose F/T Subflow** option as shown below.

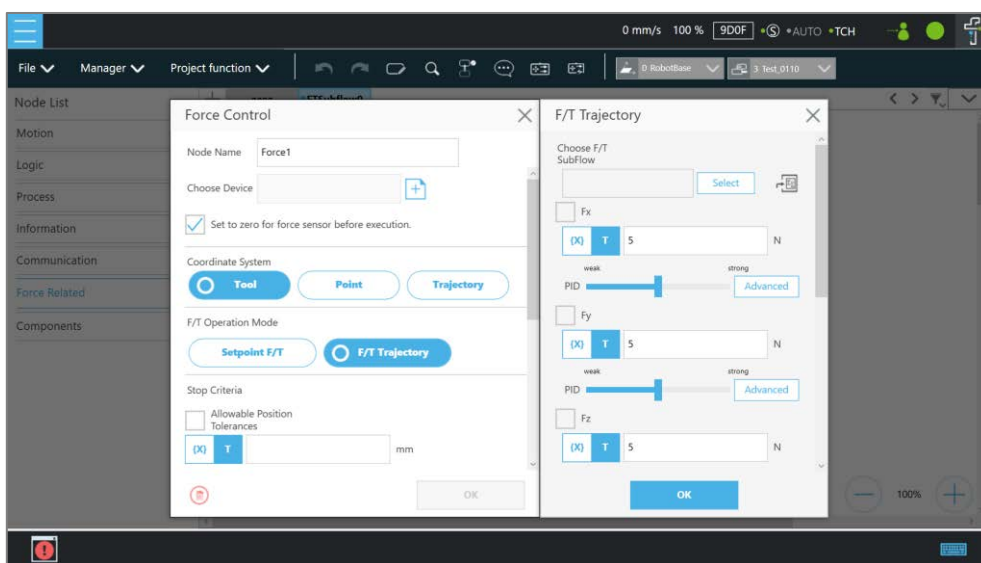

Figure 14 - 30: F/T Operation Modes – Trajectory (1/3)

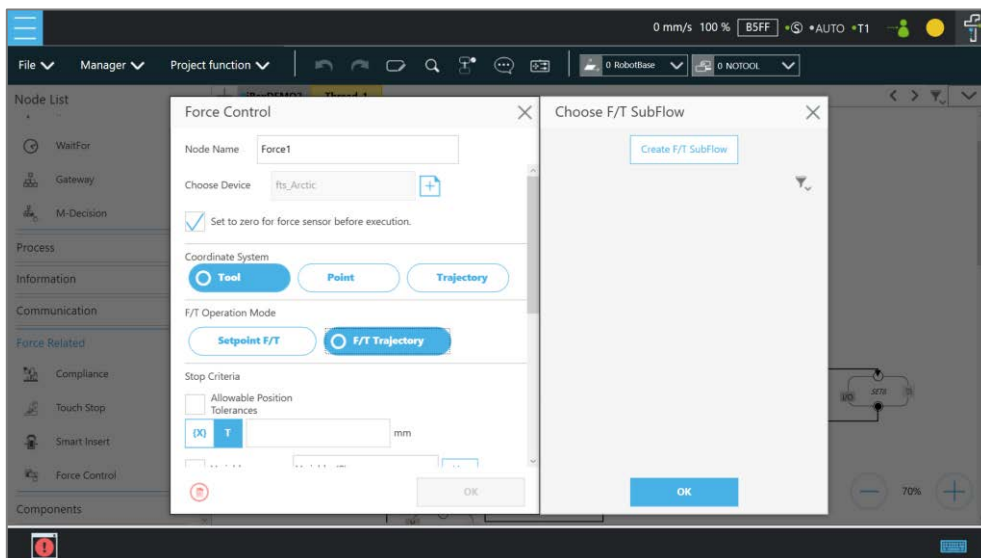



Figure 14 - 31: F/T Operation Modes – Trajectory (2/3)

In the **F/T Subflow** of the **Trajectory**, the **TCP** of the path needs to be consistent with the **TCP** of the previous position of the **Force Control** node as shown in the figure below; otherwise the robot will stop immediately and report an error that the difference is too big. Users can click  to select a variable as a value to apply.

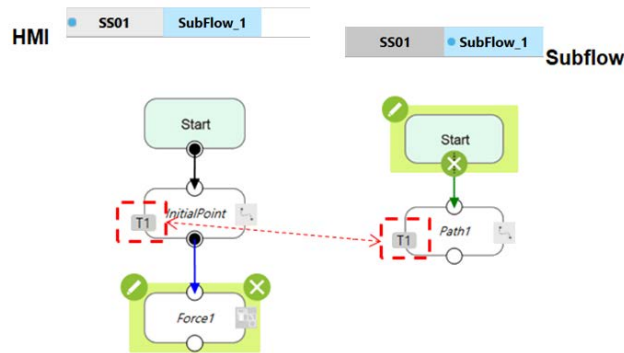



Figure 14 - 32: F/T Operation Modes – Trajectory (3/3)



**Warning:**

During force control (as in the force control node), the deceleration caused by triggering Human-Machine Safety Settings will not be in effect. But the monitoring of the respective safety limit will still be functioning. It requires the risk assessment of users to reduce or to keep from the hazards of human intervention during the force control procedure, such as using a safeguard for protective stop.

■ **Stop Criteria:**

- **Timeout:** Set the length of time to stop and release this node. Click  to select a variable as a value to apply.
- **Allowable Position Tolerances:** When the robot follows the machining path for force control, because the position of the workpiece is not the same as the path planning, it may cause the robot to move in the direction of force control resulting in machining errors. Users can set the allowable machining error. If the actual machining path is different from the planned path and exceeds the allowable machining error, the robot will release the Force Control node. Click  to select a variable as a value to apply.
- **Variable:** Set rules to judge from the outcomes of variables in expressions
- **Digital Input:** Set a digital Input signal to release this node once a specific DI is triggered
- **Analog Input:** Set an analog input signal that, when met, the node is released.
- **F/T Reached:** Set the values of the force or the torque on the custom axes as the

criteria to detect. Check the box before **Use Absolute Values** to use absolute values only. Other than **F3D** and **T3D**, users can set negative values for the opposite direction of the force or the torque.

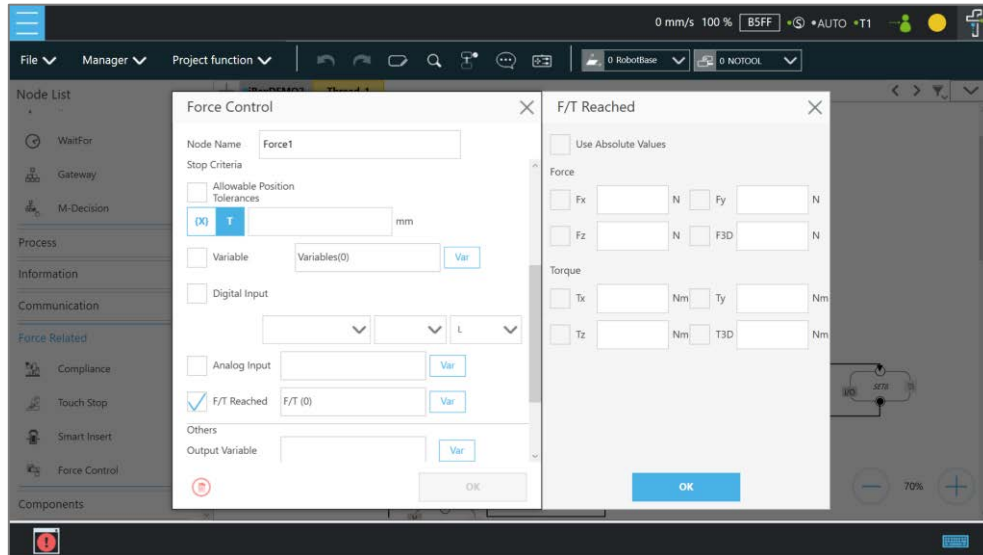



Figure 14 - 33: Stop Criteria – F/T Reached

■ **Others:**

- **Output Variable:** An integer to show the result of the Compliance, meaning which criteria are being triggered in the first place, and should have the following possibilities:
  - 2 Timeout
  - 3 Distance Reach
  - 6 ERROR (including TCP speed over limit, incorrect timing of DI triggered, etc.)
  - 14 Over Speed
  - 201 Digital Input
  - 202 Analog Input
  - 203 Variable
  - 204 Force Satisfied
  - 205 Over Allowable Position Tolerances
  - 206 Motion Finish
- **Change payload to:** If equipped, set the weight of the device at the end of the robot in kilograms. Click the  button to select a variable as a value to apply.
- **Compliance Duration when Stop:** Set the length of the time between force control and position control. Defaults to 200 ms, the value is valid between 0 and 1000 ms as an integer and supports the variable setting. Click  to select a variable as a value to

apply.

- Press the button to have the robot start moving at 3% of project speed for testing. Press the button to stop.



**NOTE:**

The system will report an error and light in red if no device is in the node setting.

## Operation Scene

### 1.58 Overview

**Operation Scene** comes with the interface for users viewing and setting the operation scene of the project, and users can tweak the positions of objects in the operation scene. **Collision Check Node** will check whether objects and the robot will collide according to the operation scene of the project.

### 1.59 Operation Scene Setting Page

At the top left, click **Project function > Operation Scene** to go to the Operation Scene Setting Page. Users can open the scene file to choose the object and tweak its position in the dialog box. Then, click **Apply** to preview. After the setting is complete, click the **Set** to save and set the project scene and exit the setting page.

### 1.60 Export/Import Operation Scene

#### 1.60.1 Export Operation Scene

Users can export the saved operation scene for use in general or along with the project for use in particular.

- For use in general, operation scene links and related scenery files are exported together as steps below.
  1. Navigate to ☰, click **System > Import/Export**.
  2. Click **Export** on the top left, and click **Operation**.
  3. Click **Export** at the bottom right to export.
- For use in particular with the project, operation scene links and related scenery files are exported together along with the project file. Refer to examples in 1.28.5 Import/Export.

#### 1.60.2 Import Operation Scene

Users can import created operations spaces to use in TMflow.

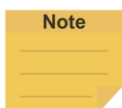

#### **NOTE:**

If imported from TMstudio, rename the file to **SafetySpace** and put the file in the path **TM\_Export\Robotname\** on a flash drive labeled **TMROBOT** where Robotname denotes the ID of the robot. After importing, users are able to open the operation scene with the scenery file by clicking the open icon in the **Operation Scene** Setting Page.



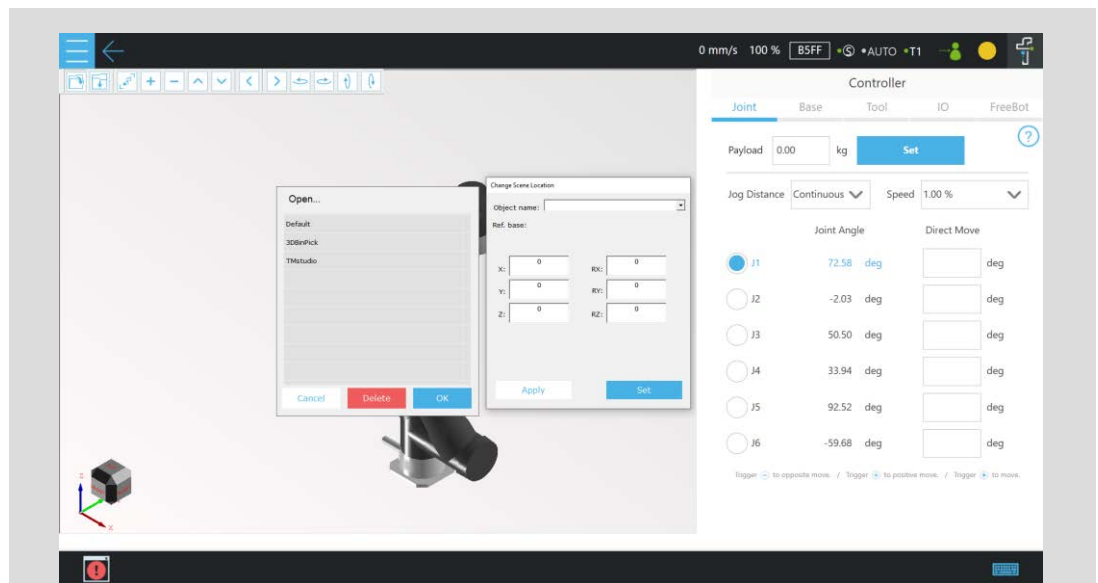

Figure 15 - 1: Import Operation Scene (1/3)

The object name and its dependent base will be shown at the top right of the 3D viewer when moving the mouse cursor on the object in the scenery file.

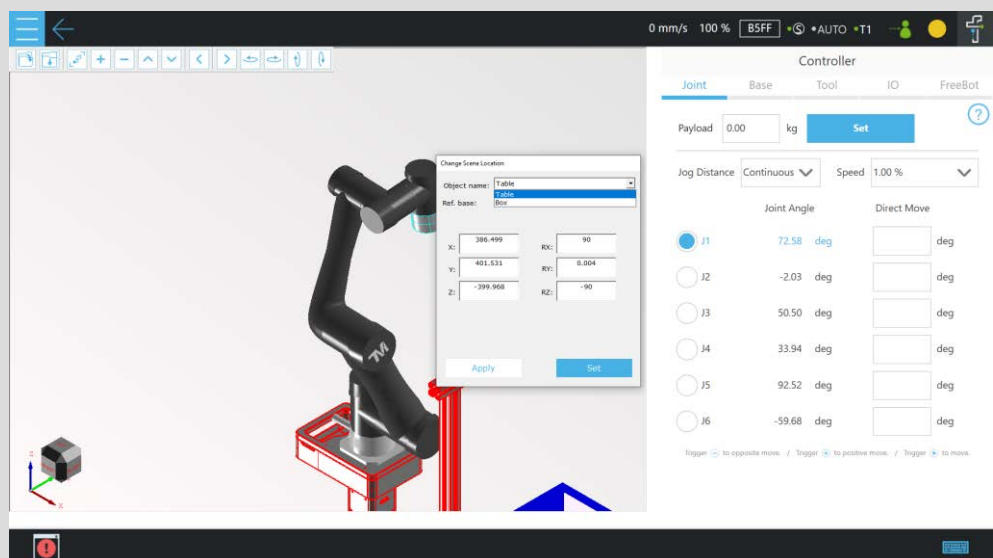

Figure 15 - 2: Import Operation Scene (2/3)

The actual position of the CAD in the scene will update as the dependent base updates. This is a great help for the collision check node to detect the collisions between the robot and the objects in the scene.

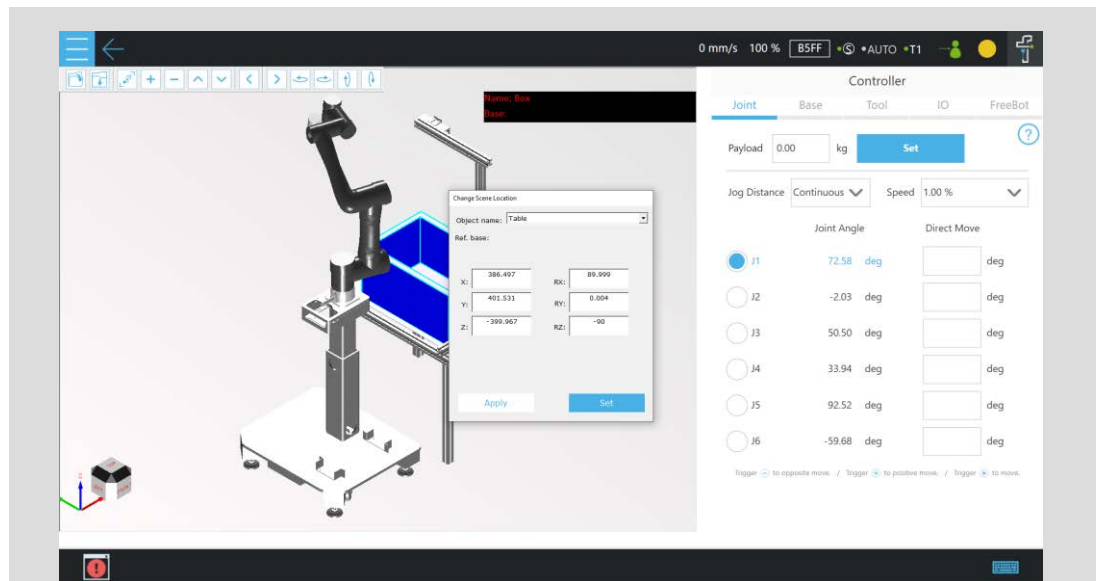



Figure 15 - 3: Import Operation Scene (3/3)

The base in the scenery file and the vision job will be included in the project while saving for using the project, and a window will prompt users to overwritten for existed names. When completed, users can select the base with TMstudio scenery and the vision job in **Base Manager** and the vision node, respectively.

To import operation scene:

1. Navigate to , click **System** > **Import/Export**.
2. Click **Import** on the top left, and click **Operation Scene** at the bottom left.
3. Select the robot to apply the imported setting in the **Robot List** prompted and click **OK**.
4. Select the project to apply the imported setting in the **Project List** prompted and click **OK**.
5. Select the project to import in the **Import Project List** prompted and click **OK**.
6. Select the name of the setting listed in **Selected Files**.
7. Click **Import** at the bottom right to import the setting.

## TM Component Editor

TM Component Editor provides developers the capability to compile nodes into components, which can be easily reused by other projects. It greatly simplifies the flow structure of repeating or similar applications. In addition, based on the diversity of product features, developer can plan the possible moving path of the robot in advance with **TM Component Editor** or design with the positioning of **TM Landmark** to create a variety of components applicable to screw driving, welding, polishing, and grinding.



### IMPORTANT:

1. TM Component is not designed for confidential encapsulation. Do not use TM Component in confidential usage.
2. TM Component is applicable to flow projects. (Script project is not supported).

### 1.61 Starting to create your first component

A component can consist of a variety of the features to make the flow structure simple as well as reusable in other projects. **TM Component Editor** provides developers with a complete mechanism to create components. Among the nodes, the **Start** node is able to configure the component's basic parameters such as its display icon, its usage, as well as its available **Global Variables** and its instruments. Moreover, developers are able to provide users with the flexibility to modify the parameters on demand. To help users to understand the usage scenarios of the developer's component quickly, **TM Component Editor** manages a naming rule.

#### 1.61.1 TM Component Editor settings

##### 1.61.1.1 Start node

Developers can click on the **Start** node for basic settings. In the basic settings, Provider is the name of the developer, Name and Type stand for the name and the type of the node respectively, and Icon is the image to represent the component. In addition, **TM Component Editor** can pack available **Global Variables** and instruments together into the component, and show the results in the branches of the **Gateway** node.

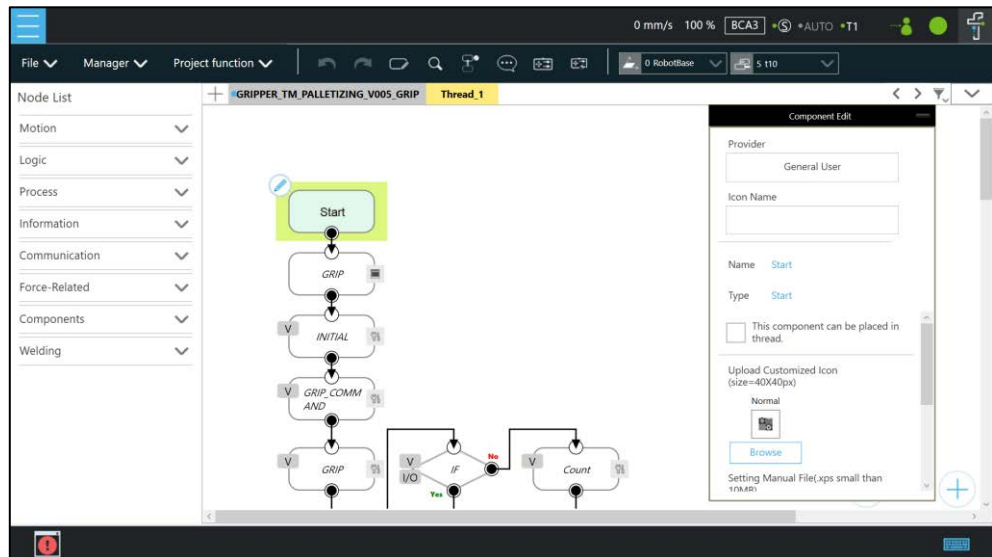

Figure 16 - 1: Start Node

- **Provider:** Provider is the name of the developer or the company that packs the component. When dragging a created component as a node in **TMflow**, the information of the developer will be displayed in the field as the creator.



**IMPORTANT:**

Components will not be saved if they do not follow the correct naming convention. This includes but is not limited to using “Omron” or “Techman” affiliated names as the provider.

- **Icon Name:** Users can use a desired name for the component listed in the node list. The icon name is for used in the node list only. Once dragged into flow editing area, it displays the component name.
- **Name:** Name is the name of the currently selected node. Developers may edit the name in the edit function of the node to optimize the visibility of the flow. This item can be used by developers to check the correctness of the current modifying node.
- **Type:** Type can be used by developers to check the correctness of the current modifying node.
- **This component can be used in TM Component Editor:** This item sets if the component is available for use in TM Component Editor. Refer to 1.63.2 Use component in TM Component Editor for the usage.
- **This component can be placed in thread:** This item sets if the component is available for use in a thread. To tick, the component must not come without motion nodes, or it will get a denial while saving the file.

- **Icon:** Developers can set up two different icons for “normal” and “clicked” status of the component. Only image files in the USB drive labeled with **TMROBOT** can be imported.



**IMPORTANT:**

The component’s icon supports PNG image files only, and the suggested maximum resolution is 40 x 40 pixels to avoid distortion or blur.

- **Manual:** Developers can import a manual file in XPS format, from the USB drive labeled with **TMROBOT**, to guide users. Once imported the XPS file, users can click the icon to check its correctness.



**IMPORTANT:**

Make sure the file size of your XPS is less than 10MB or it will not be accepted.

- **Select Exit From Gateway nodes:** This item sets the branches of the component. Developers have to select a **Gateway** node as the exit of the component and the possible results branch over the **Gateway** node exits according to the logic. Users can process the flow with the respective programs provided by the developers.



**IMPORTANT:**

You can change the variables in the results with the **SET** node while planning the flow, and use **Case** in the **Gateway** node to judge the variables in the results and lead the results to the different position. If the selected **Gateway** node as the exit comes with child nodes, the child nodes will be ignored.

- **Command List:** This item sets the checked command sets embedded into the **Component**. When users import the component, the checked command list will be imported also.
- **TCP List:** This item sets the checked **TCP** list embedded into the **Component**. When users import the **Component**, the parameters will be imported also. The prefix of the **TCP** has to go with the first two names (Application\_Provider\_) of the project name in **TM Component Editor**; otherwise, they will not appear in **TM Component Editor**.
- **Global Variable List:** This item sets the **Global Variables** used by the developer

embedded into the **Component**, so the variable conveyance in different **Components** is achievable. The first two names have to be identical to the names in the project; otherwise, they will not appear in **TM Component Editor**. For the naming rule of **TM Component Editor**, refer to 1.61.2 TM Component Editor Naming Rule.



**IMPORTANT:**

Inappropriate changes of the project names in **TM Component** may result in missing of the embedded **Global Variables**.

1.61.1.2 Node settings

- **Sort:** This item sorts the orders of the nodes present in the **Component**. The smaller the number is, the higher the order is.



**IMPORTANT:**

The available input range of the order to sort is from 0 to 1024. If the input number is beyond the maximum, the returned value is 1024.

- **Are setting items in this node visible:** This item sets the node in **TM Component Editor** to be editable by users. When an **IF** node is set to **Display** and its flow is packed in a component, clicking edit in the component will present the node in the component as shown below.

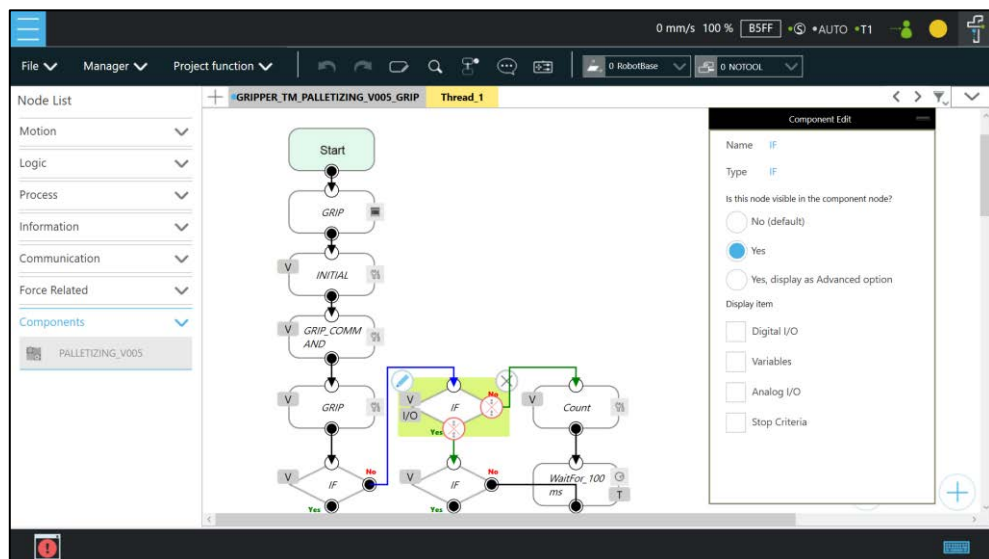

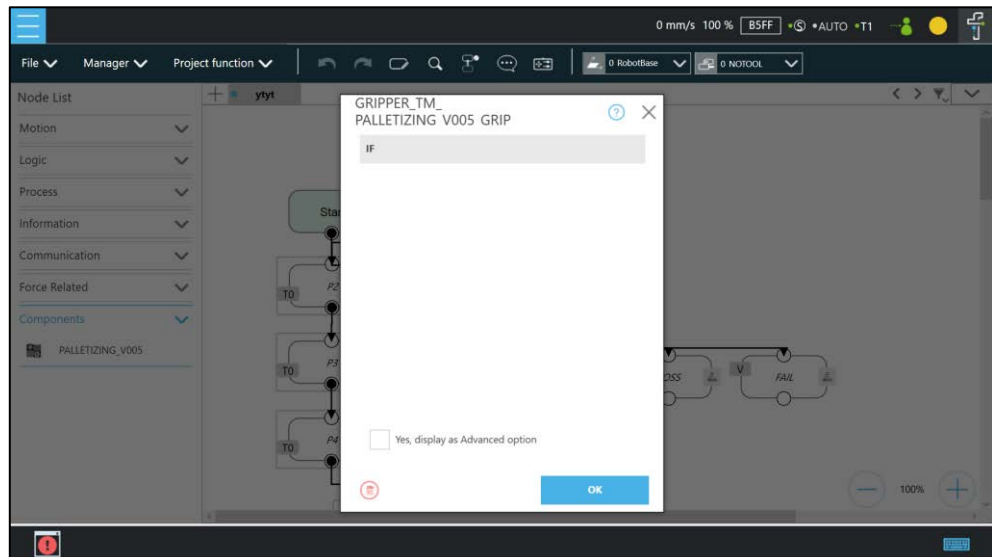

Figure 16 - 2: Node Setting (1/2)

- **Displayed in Basic/Advanced setting list:** This item sorts the nodes present in the component. Developers of **TM Component Editor** can partition the levels of the nodes present in the component. First-time users can begin with the basic functions and the simplified interface, and advanced users can check **Advanced** for more advanced applications.



**IMPORTANT:**

Once **Advanced** is checked, the nodes present in the component will be rearranged by the input number of Sort.

- **Display Item:** This item sets the items available for users to modify in the **Component**. For example, if the **IF** node is set to **Display** as shown below and **Digital I/O** and **Analog I/O** are both checked, after the component is dragged into the project, users can select parameters of **Digital I/O** and **Analog I/O** to append or modify by checking the boxes in **Display Item** of the **IF** node in the **Component**.

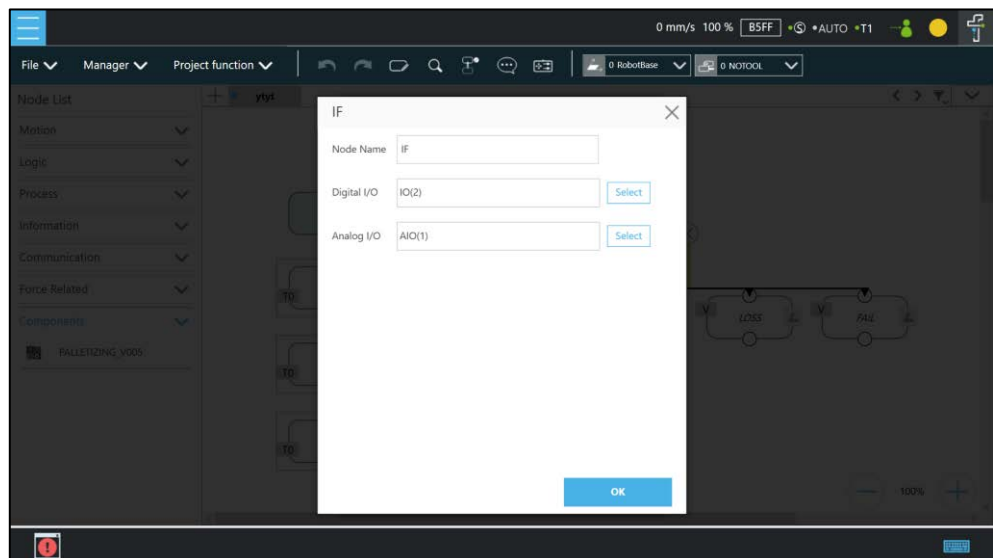
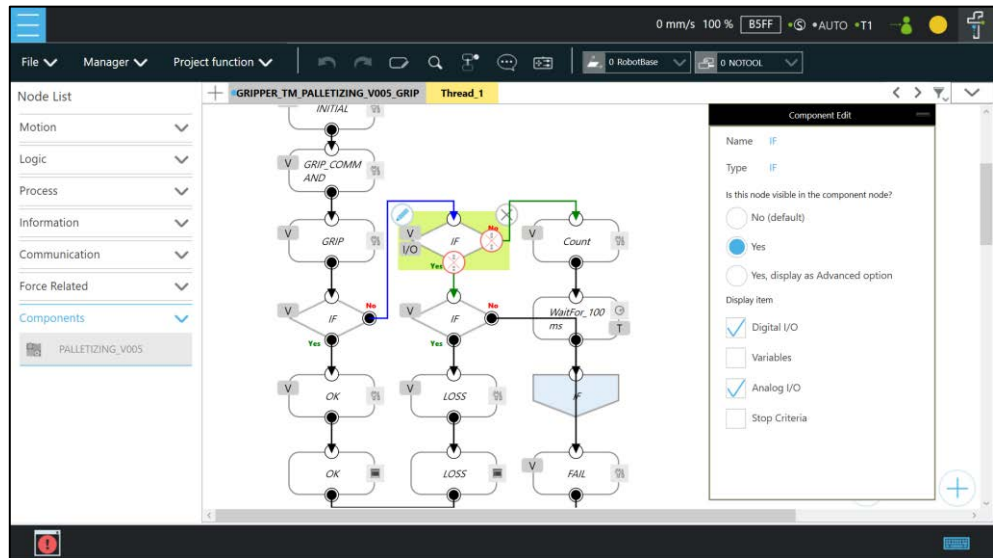

Figure 16 - 3: Node Setting (2/2)

- **DeviceReadOnly:** This item is applicable to force control related nodes. Developers can set the properties of the force sensing devices to **DeviceReadOnly** to lock available force sensing devices and prevent users from modifying them. Refer to 1.63.4 The example of point parameterization application for detailed applications.

### 1.61.2 TM Component Editor Naming Rule

The naming rule is intended to help users understand the purpose of the component quickly and completely. To help developers understand component development consistently and intuitively, **TM Component Editor** regulates the naming in part of the parameters to enhance readability



with applicable categories of components, which will go through one by one in the following.

### 1.61.2.1 Component Naming

The naming rule of **TM Component Editor** goes by  
Application\_Provider\_Model\_Version\_Function.

Name	Description & Examples
Application	GRIPPER
Provider	Omron
Model	Adaptive
Version	V001
Function	GRIP

Table 20: Component Naming



**IMPORTANT:**

Do not use reserved words such as var in naming.

The maximum characters available in naming compounded with the component and the vision task is 126, otherwise the vision task may not function normally.

Item	Rule	Examples		
		Component Name	Item Name	Name for Imported Component
Variable	component name # _item name	A_B_C_V001_D	var_A	A_B_C_V001_D1_var_A
point	component name # _item name	A_B_C_V001_D	P1	A_B_C_V001_D1_P1
Set	component name # _item name	A_B_C_V001_D	SET	A_B_C_V001_D1_SET
Base	component name # _item name	A_B_C_V001_D	Base1	A_B_C_V001_D1_Base1
Vision Base	vision_comp onent name # _item name	A_B_C_V001_D	vision_Landmark	vision_A_B_C_V001_D1_Land mark
Device	component	A_B_C_V001_D	mrtu_Gripper	A_B_C_V001_D1_mrtu_Gripper

Item	Rule	Examples		
		Component Name	Item Name	Name for Imported Component
	name # _item name			
Global Variable	item name	A_B_C_V001_D	A_B_Variable	A_B_Variable
TCP	item name	A_B_C_V001_D	A_B_TCP	A_B_TCP

Table 21: Naming Rule for Items after Components

### 1.61.2.2 Global Variables Naming

The prefix of a **Global Variable** has to be the first two names (Application\_Provider\_) of the project name in **TM Component Editor**. Inappropriate naming of **Global Variables** may result in existing **Global Variables** being overwritten. Refer to 1.63.1 Global Variables for **Global Variable** applications.

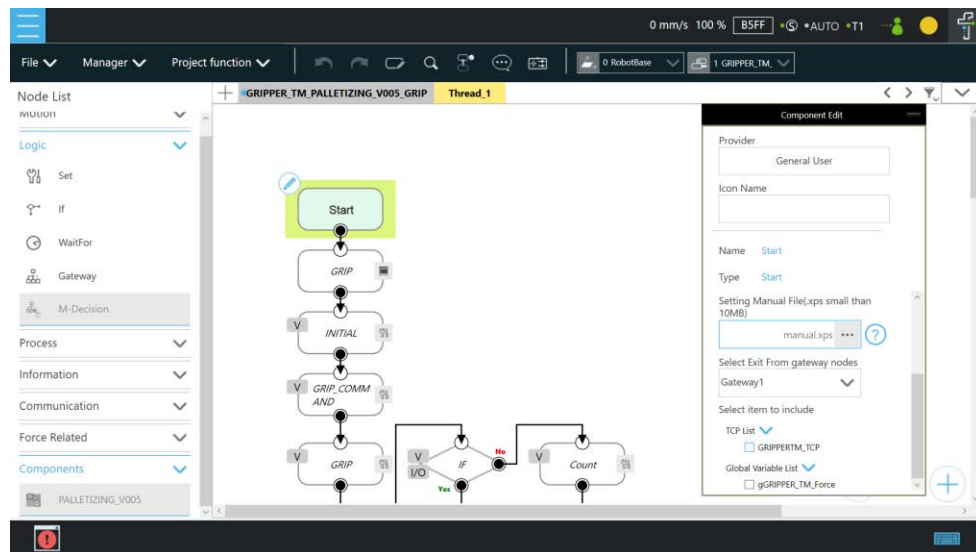

Figure 16 - 4: Global Variables Naming



**IMPORTANT:**

Inappropriate changes of project names in **TM Component** may result in missing of the embedded **Global Variables**.

### 1.62 Devices

In **TM Component Editor**, you can edit the devices in advance, such as **F/T Sensor devices**, **Modbus devices**, **Network devices**, and embed the devices in the **Component**. The supported devices of TM Robot will be covered one by one below.

### 1.62.1 Modbus Devices

In **TM Component Editor**, you can set the parameters of the Modbus TCP/RTU devices and have the devices embedded in the **Component**. By dragging the **Component** in **TMflow** to have a Modbus device added, users can configure the Modbus device in the list at the right of the screen.



#### **IMPORTANT:**

The local IP will not be embedded in the Modbus device of the component by default. To use a local IP, add a new device and input 127.0.0.1 and 502 as the IP address and port number respectively.

### 1.62.2 Network Devices

In **TM Component Editor**, users can add a new network device newly added by the **Network** node embedded to the **Component**. Dragging the **Component** in **TMflow** will add a **Network device**.

### 1.62.3 Force Sensing Devices

In **TM Component Editor**, you can have the parameters of communication and physics in the force sensing devices embedded in the **Component**. By dragging the component in **TMflow**, users can merely configure the serial port address to match the actually connected address for making use of the **Component** established with the device in the flow. Check **DeviceReadOnly** to limit the component users to using the developer set devices. For how to set available devices in a component, refer to 1.63.5 The example of making parameterized devices.

## 1.63 Features & Applicable Examples

This section goes through the principal ideas of programming, techniques, examples including **Global Variables**, **Subflows**, parameterizations, etc. The applicable methods and scenarios are introduced below as a reference for developers to program in simple ways.

### 1.63.1 Global Variables

Users can click **Global Variables** in **Configuration** to enter the **Global Variable** system. With **Global Variables**, **TM Component Editor** may deliver values to various **Components**. The example below divides the components of the **Gripper Button** into **SET**, **GRIP**, and **RELEASE**. **SET** is for setting parameters of the Gripper Button. **GRIP** and **RELEASE** go without parameter settings but merely hold and free the object respectively.

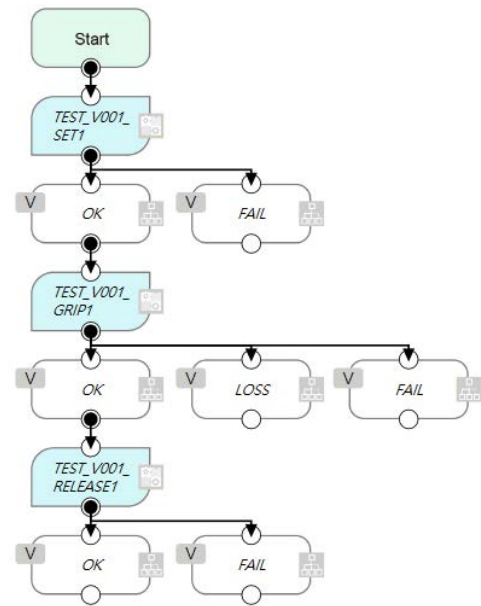

Figure 16 - 5: Global Variables

If parameters of the **Gripper Button** are set in **GRIP**, the settings in **GRIP** will refresh to the defaults when adding a new component, which means the parameters of **GRIP** of the **Gripper Button** will return to the values set by the developer. However, if the parameters are changed in **SET** as **Global Variables**, the **Gripper Button** will apply the user setting parameters while executing **GRIP** and **RELEASE**.



**IMPORTANT:**

**Global Variables** will not lose their values because of a system shutdown. When using a **Global Variable**, the prefix of the **Global Variable** has to go with the first two names (Application\_Provider\_) of the project name in **TM Component Editor**.

1.63.2 Use component in TM Component Editor

A **TM Component Editor** programmed component can check “**This component can use in TM Component Editor**” in the right via the **Start** node. This feature is applicable to the secondary development of **Components** such as the developers of force sensing devices, who can integrate the existing **Component** of the **Gripper Button** to expand the component’s functions and save time and development costs.



**IMPORTANT:**

Once the component established by packing the project, the parameters of the component used in **TMflow** will apply the names,

Application\_Provider\_Model\_Version\_Function, in order. Users have to define the prefixes of the **Components** used in **TM Component Editor** on their own.



**NOTE:**

If variables of a **Component** in **TM Component Editor** are set for users' modifications, developers can make the respective variables in the **Component** equal to custom variables and types in **TM Component Editor**, and have users modify the **Variables** by the **SET** node.

### 1.63.3 Component Inheritance

If there is a **Component** node in **TMflow**, then dragging another identical **Component** prompts users to either create a new component instance or use the same parameters as the old one. When choosing **Select the Existing Component**, the declared variables, devices, coordinates, and TCP parameters are shared between the identical component instances. When choosing **Make it as a New Component**, different serial names will apply to the declared variables, devices, coordinates, and **TCP** parameters of the new component instance. In the case of a **Gripper Button**-generated **Component**, it chooses the last selected existing component. If the previous user operation is to add a component or it is unavailable to choose the **Select the existing component**, it will select the last added one. In the case of version changing with the identical component, users can use the **Replace the existing component** to update the identical one in **TMflow**.

### 1.63.4 The example of point parameterization application

If developers are unable to estimate the number of points in **TM Component Editor**, they can achieve through parameterization and the string processing function in **TMflow**. As an example, the component programming of the plugin illustrates below.

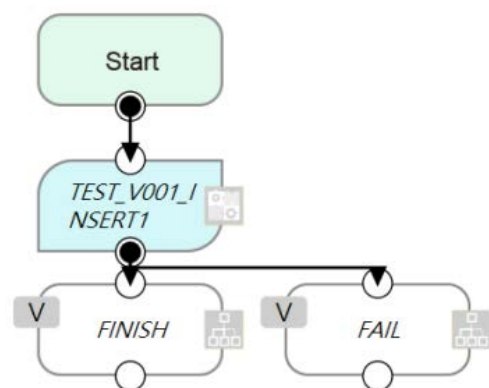

Figure 16 - 6: The Example of Point Parameterization Application (1/4)

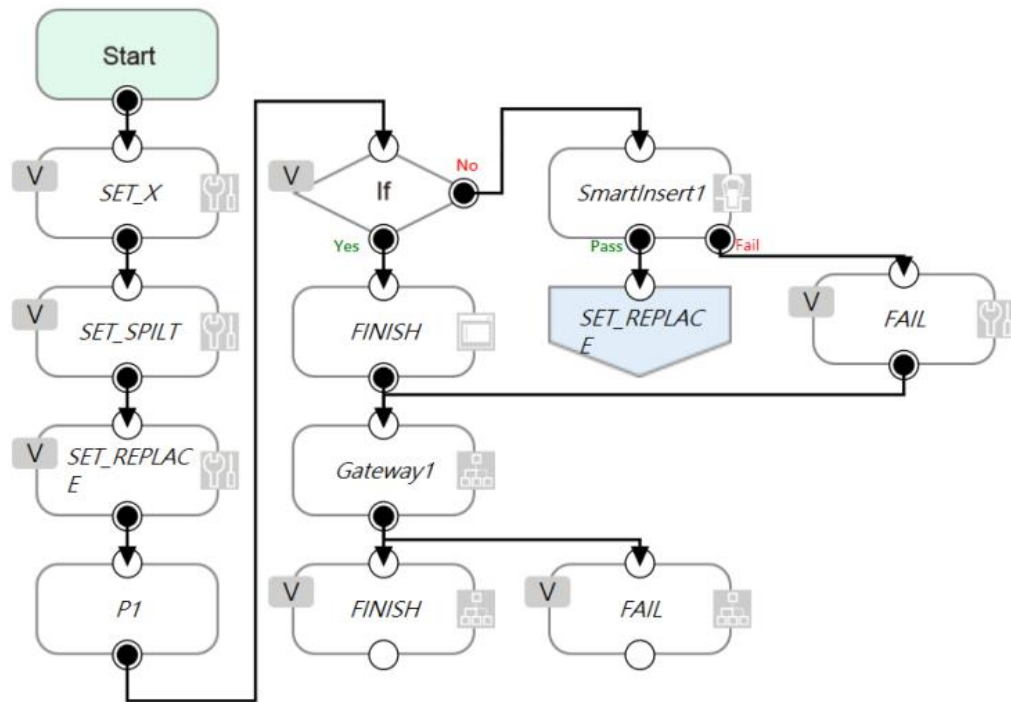
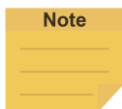

Figure 16 - 7: The Example of Point Parameterization Application (2/4)

In the flow above, the coordinate of the **Component** plugin comes from a 3D CAD file. To developers, the user's coordinates and the number remain unknown. This example uses the X-axis as an explanation. Developers can plan the string structure that users understand easily in advance, and use the string processing function in **TMflow** to retrieve the position of the X-axis by means of the matrix format. Then, developers can replace the position of a single point with the parameterization function for the string returned. Finally, determine whether all plug-in processes are completed according to the size of the matrix.



**NOTE:**

Parameterization does not include the status of **Operation Scene**, **Set IO while Project Error**, **Set IO while Project Stop**, and **Stop Watch**.

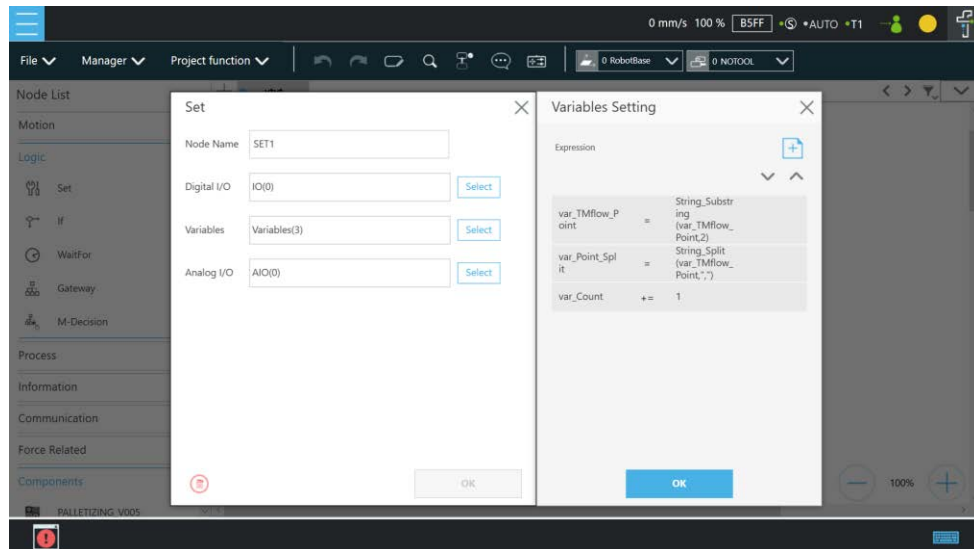

Figure 16 - 8: The Example of Point Parameterization Application (3/4)

With this architecture, the algorithm is programmed by **TMflow** to disassemble the string to deal with the number of points unknown. The following figure shows users an example of a string structure in this component. Users can change the point as needed.

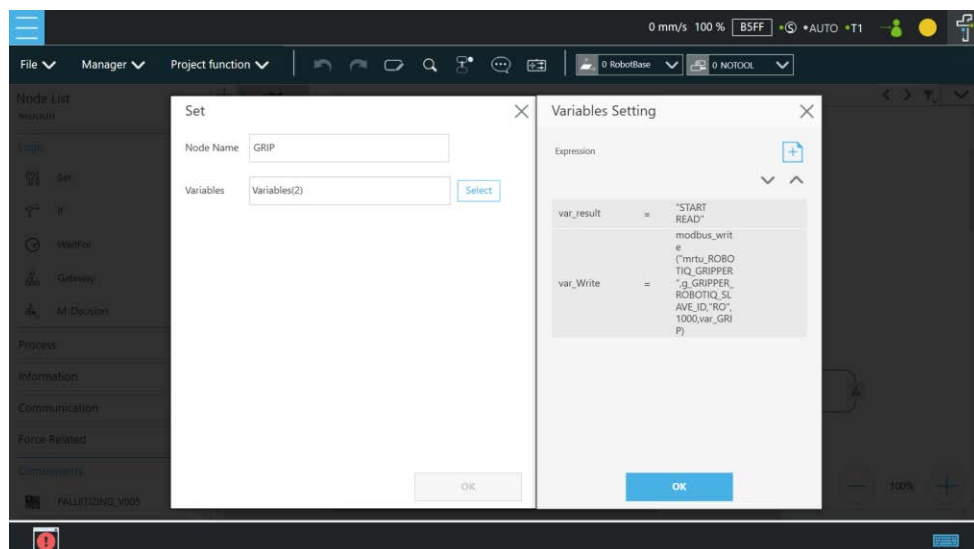

Figure 16 - 9: The Example of Point Parameterization Application (4/4)



**NOTE:**

The point positions required in the example above can be achieved by using the **Command** node to read the notepad in the network shared folder or by importing from a text file in **Variable** if the data type is string.

1.63.5 The example of making parameterized devices

As shown below, developers can use the device parameterization function to restrict modules under the name of the device and use the **DeviceReadOnly** property to prohibit users from changing devices. This method can limit available devices in the component.

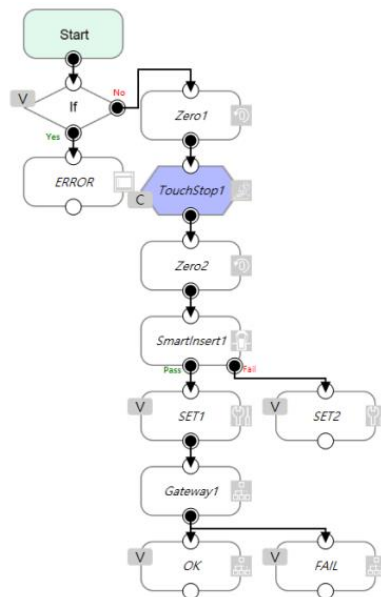
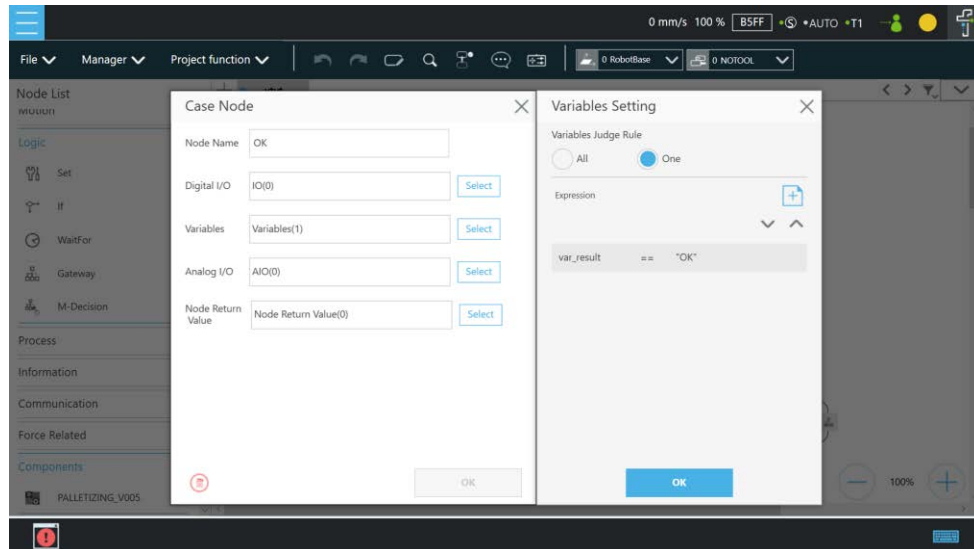

Figure 16 - 10: The Example of Making Parameterized Devices

### 1.63.6 Use thread in TM Component Editor

The thread function is available in **TM Component Editor**, so status monitoring and data acquisition are independent of the robot, and the thread page precedes data interception and analysis. Users are able to read the data or renew the variables in the thread page. Components cannot be dragged into thread pages of the project. If needed, users can delete the page by selecting delete at the edit window of the **Start** node in the child page.





**IMPORTANT:**

If there is a component coming with the thread page in **TMflow**, no new thread page will come into being when clicking inherit. However, a new thread page will come into being when clicking add a new component. Developers have to be careful to plan the flow to avoid logical conflicts resulted from threads between components.



**NOTE:**

1. **Non-pause Thread** is applicable to a component.
2. If setting the node in the thread as a display item, the display item will present in light blue.
3. When users put numerous identical components selected to inherit in the flow and, all the parameters of the components to inherit in the thread will update in synchronicity.

#### 1.63.7 Use subflow in TM Component Editor

While programming components in **TM Component Editor**, as the number of nodes increases, some blocks in the **Component** could be reused or nodes in the blocks could be categorized. It is possible that the poor modifications in the nodes of the block results in inconsistent parameters. Therefore, using the **Subflow** node page to frame the concept of modularization, users can simplify the flow of the component programming as well as enhance the readability of the logic in the programming. It is recommended to use the **Subflow** pages as much as possible while programming the **Component**. To delete the page, select delete at the edit window of the **Start** node in the child page.

#### 1.63.8 Hide parameters

**TM Component Editor** lets developers cover part of parameters. After selecting variables, bases, and points in **TM Component Editor**, developers can select whether to show parameters in the base manager, the base list, the point manager, and the variable list in **TMflow** after dragging the packed **Component** in the flow.

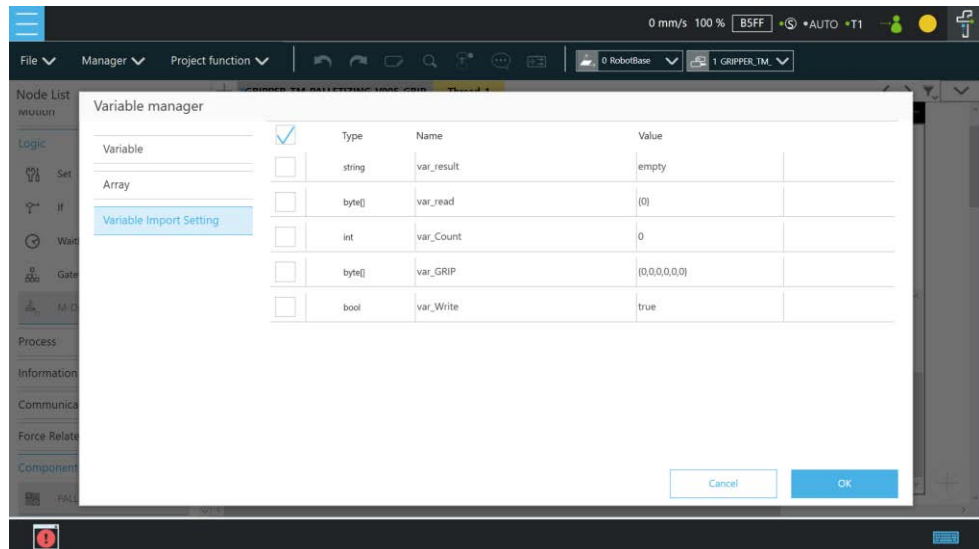

Figure 16 - 11: Hide Parameters

## 1.64 Use the component

Once users have completed the **Component** programming, users can export the **Component** to various projects and make the **Component** available to others. The following goes through how to activate the **Component** to apply to the **Project Page** and make it available to others.

### 1.64.1 Activate the component

When selecting the **Gateway** node as the exit in **TM Component Editor** and clicking save, **TMflow** will create a component with the project. In the meantime, users can activate the created **Component** in the **Component List** by navigating to **≡ > Configuration > Component**, and the **Component** should come out as a node in the node list.

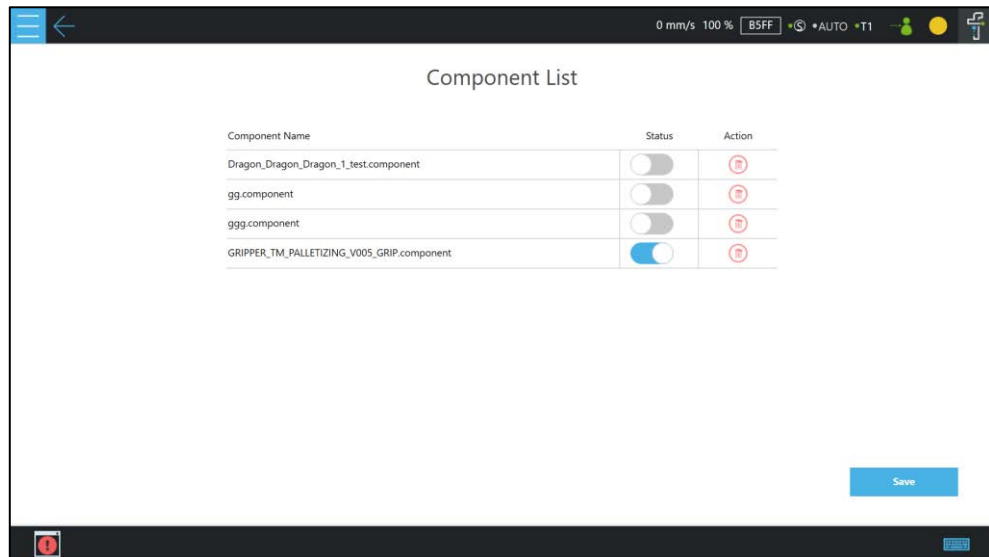

Figure 16 - 12: Activate the Component

### 1.64.2 Import/Export Components

Navigate to  $\equiv >$  **System** > **Import/Export** to export the component to the USB driver labeled with **TMROBOT** and import the component onto the users' TM control box and to make it available to users.



#### IMPORTANT:

- After being imported, it is required to activate the component in the **Component List** by navigating to  $\equiv >$  **Setting** > **Component** before using.
- A component that is imported with the same name as a component in use will overwrite the settings of the component in use.



#### NOTE:

Components created in newer versions of TMflow are not applicable to older versions of TMflow.

## 1.65 Collision Check

The Collision Check comes with solutions to provide against issues of the robot's interfering in the self test and the collisions between the gripper and the box. With proper settings and editing based on the scene exported by TMstudio or the simple box container built in TMvision, users can simulate robot motions with robot parts, tools, and virtual boxes to check target motions in advance for collisions in 3D random bin picking applications, large tools, critical poses, and etc.

Before using the collision check node in TMflow in the flow project or declaring the viewer class for collision detection in the script project, users should use TMstudio to configure the robot model and import the gripper CAD file for the zero point and the angle settings with the flange attached. When the TCP of the gripper is set, export the gripper CAD file zipped with files of xml, tcp, and stp to a flash drive labeled **TMROBOT**. Next, refer to 1.28.5 Import/Export to import the zipped file in TMflow by selecting **TCP** for the data type, and refer to 1.36.2 Create Tool Center Point by Input Parameters to adjust values. Also, users can add a new vision job to generate a vision base array after recognized to use in the collision check. The following will introduce collision check through a flow project.

## 1.66 Collision Check Node

In TMflow, drag a collision check node from the node list to the **Flow Editing Area**, and use the node to create a subflow for teaching points. The maximum nodes available in this subflow is 100. The teaching points will be checked with collisions. Once the flow turns to the collision check node in the project page, the flow proceeds to the nodes in the subflow for collision checking. If there is no collision, the flow will depart from **Pass** of the collision check node; otherwise, the flow will depart from **Fail** of the collision check node. In addition, users can set the **Safety Distance** as a buffer for the robot to detect collisions and select **Simulation Speed** to apply to the trial run in the 3D simulator.

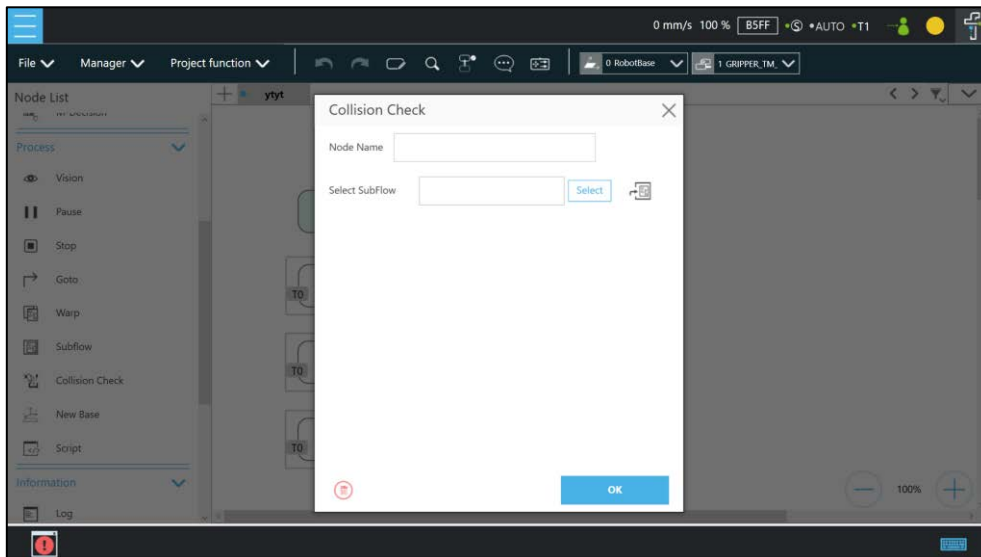

Figure 17 - 1: Collision Check Node

**Note**

**NOTE:**

If the robot has a TMstudio TCP file with a large CAD model import into its Operation Scene, it could cause a significant delay when playing a project for the first time after power cycling the robot. This behavior occurs because the robot must load the large CAD model into the workspace upon pressing Play for the first time after power cycling. To mitigate this delay, please generate a TCP in TMstudio using a smaller CAD model.

## Appendix A: Display of Indication Light Ring

Users can recognize the operation mode and status of the TM Robot from the **Indication Light Ring**. Each light indication comes with a maximum of 2 different colors, and the colors go with various blinking ratios to provide additional status information of the robot. There are two main categories of light indication: Special Light Indication and Regular Light Indication.

### 1. Special Light Indication

Initializing:	Alternating between Red and Light Off equally
Power On with STO status:	Failed to finish booting up and Light Off (Buzzer no beep)
Power On with SOS status:	Finished booting up and the light indicated as the tables below.
Robot in STO status:	Light Off (Buzzer no beep)
Robot in SOS status:	Light indicated as the tables below.
Updating:	Alternating between Red and Light Off equally (at doubled speed)
Fatal Error(Need to re-boot):	Solid Red Light (Buzzer emits a long beep)



#### NOTE:

- STO (Safe Torque Off)\* status condition includes:
  1. Category 0 Stop.
  2. Category 1 Stop.
  3. Emergency Stop function input LOW signal.
- SOS (Safe Operation Stop)\* status condition includes:
  1. Safeguard function Input LOW signal.
  2. Enabling Switch function at OFF Status.
  3. Under safety configuration status of either safety-related parameters parameterization, Robot Stick MODE Switch function or Enable/Disable of Robot Stick function.

Refer to *Safety Manual* for details.

\*Both names come from IEC 61800-5-2.

### 2. Regular Light Indication

The regular Light Indication alternates between 2 categories of light indication: Operation Mode Light Indication and Auxiliary Light Indication. The blinking ratio of the light indications indicates the various status of the robot. In addition, the display color of Auxiliary Light Indication prioritizes by conditions.

#### 2.1 Operation Mode Light Indication

- AUTO MODE: White
- MANUAL MODE: Green
- Not in Operation: Light Off

## 2.2 Auxiliary Light Indication (Sort by display priority)

- Error: Red
- Recovery Mode: Yellow
- Maintenance Settings: Blue
- Trigger Human-Machine Safety Settings: Purple
- Normal: Light Off

## 2.3 Ratio of blinking time period

The table below shows the rule of the blinking ratio between Operation Mode Light Color and Auxiliary Light Color.

Status			Blinking Ratio	
			Operation Mode Light Indication	Auxiliary Light Indication
Error			50%	50%
Paused in Project or system under SOS status			10%	90%
Not Paused	Project is not running (Incl. Hold to Run and Step Run)	Normal	100%	-
		Trigger Human-Machine Safety Settings	90%	10%
	Project is running		50%	50%

Table 22: Blinking Ratio

The table below shows all Regular Light Indication combinations.

Operation Mode	Running status	Space/Status	Operation Mode Light Indication	Auxiliary Light Indication
MANUAL MODE	Hold to Run or Step Run	Normal	Green (100%)	-
		Error	Green (50%)	Red (50%)
		In Recovery Mode	Green (50%)	Yellow (50%)
		Trigger Maintenance Settings	Green (90%)	Blue (10%)
		Trigger Human-Machine Safety Settings	Green (90%)	Purple (10%)
	Project is running	Normal	Green (50%)	Light Off (50%)
		Error	Green (50%)	Red (50%)
		In Recovery Mode	Green (50%)	Yellow (50%)
		Trigger Maintenance Settings	Green (50%)	Blue (50%)
		Trigger Human-Machine Safety Settings	Green (50%)	Purple (50%)
	System under SOS	Normal	Green (10%)	Light Off (90%)

Operation Mode	Running status	Space/Status	Operation Mode Light Indication	Auxiliary Light Indication
	status	Error	Green (50%)	Red (50%)
		In Recovery Mode	Green (50%)	Yellow (50%)
		Trigger Maintenance Settings	Green (10%)	Blue (90%)
		Trigger Human-Machine Safety Settings	Green (10%)	Purple (90%)
AUTO MODE	Project is not running	Normal	White (100%)	-
		Error	White (50%)	Red (50%)
		In Recovery Mode	White (50%)	Yellow (50%)
		Trigger Maintenance Settings	White (90%)	Blue (10%)
		Trigger Human-Machine Safety Settings	White (90%)	Purple (10%)
	Project is running	Normal	White (50%)	Light Off (50%)
		Error	White (50%)	Red (50%)
		In Recovery Mode	White (50%)	Yellow (50%)
		Trigger Maintenance Settings	White (50%)	Blue (50%)
		Trigger Human-Machine Safety Settings	White (50%)	Purple (50%)
	Paused in Project or system under SOS status	Normal	White (10%)	Light Off (90%)
		Error	White (50%)	Red (50%)
		In Recovery Mode	White (50%)	Yellow (50%)
		Trigger Maintenance Settings	White (10%)	Blue (90%)
		Trigger Human-Machine Safety Settings	White (10%)	Purple (90%)

Table 23: Light Indications

The table illustrates a quick reference of how to recover from different kinds of error/ status.

Color/Blinking	Description	Troubleshooting
Alternating between Green/Red light (with 2 beeps from buzzer)	MANUAL MODE Error	Press the Reset button on Robot Stick to troubleshoot the error. See <i>Safety Manual</i> for details.
Alternating between White/Red light (with 2 beeps from buzzer)	AUTO MODE Error	Press the Reset button on Robot Stick to troubleshoot the error. See <i>Safety Manual</i> for details.
Flashing red light	Robot is initializing.	Not Applicable.
Light off	Emergency Stop button pressed	Release the Emergency Stop button and press the Reset button on Robot Stick to power on the robot.
Light off	Category 0 Stop	Shutdown and restart required



Color/Blinking	Description	Troubleshooting
Buzzer emits a long beep		
Solid red light Buzzer emits a long beep	Fatal error	Shutdown and restart required

Table 24: Quick References of Color/Blinking

Appendix B: Tables of Safety Parameter Upper and Lower Bounds

**TM7S Series**

				Default Value	Min. Value	Max. Value	Unit	
Speed & Force	General	T1 Hand Guide TCP Speed Limit		250	0	250	mm/s	
		TCH Hand Guide TCP Speed Limit		450	0	750	mm/s	
		End-Point Reduced Speed Limit		250	0	250	mm/s	
	Performance Safety	Speed Limit	Safety Tool		1500	0	4500	mm/s
			J1, J2		240	0	240	deg/s
			J3		240	0	240	deg/s
			J4, J5		260	0	260	deg/s
			J6		520	0	520	deg/s
		Force Limit	TCP, Elbow		150	100	450	N
		Torque Limit	J1, J2		85000	30000	170000	mNm
			J3		85000	30000	170000	mNm
	J4		23000	8000	45000	mNm		
	J5, J6		23000	8000	45000	mNm		
	Human-Machine Safety	Speed Limit	Safety Tool		Vary from the Body Region selected.	0	4500	mm/s
			J1-J6		Default, Min. and Max. Values are the same as Performance Safety			
		Force Limit	TCP, Elbow		Default, Min. and Max. Values are the same as Performance Safety			
		Torque Limit	J1, J2		65000	30000	170000	mNm
J3			65000	30000	170000	mNm		
J4			15000	8000	45000	mNm		
J5, J6			15000	8000	45000	mNm		
Soft Axis	Default / Additional	Joint Position	J1, J2, J4, J5, J6		-	-360	360	deg
			J3		-	-152	152	deg
		Cartesian Limit A Cartesian Limit B	X, Y, Z		-	-3000	3000	mm
			$\theta_z$		-	0	359	deg
			R		-	60	3000	mm
Safety IO	Input Functions	Input Discrepancy Detection Time	Emergency Stop, Safeguard Safeguard for Human-Machine Safety, Reset, Mode Switch, Soft Axis Switch, Bumping Sensor		20	0	1000	ms
			Enabling Switch		500	0	1000	ms
	Output Functions	Safe Home	J1-J6 Position		0	-360	360	deg
			Joint Position Tolerance		1	1	3	deg
Safety Tool	Safety Tool Point	Basic	X, Y, Z		0	-700	700	mm
		Advance	X, Y, Z		0	-700	700	mm
Mounting Direction	Gravity Direction	$\alpha$		90	0	180	deg	
		$\beta$		90	0	180	deg	
		$\gamma$		180	0	180	deg	

## TM5S Series

			Default Value	Min. Value	Max. Value	Unit		
Speed & Force	General	T1 Hand Guide TCP Speed Limit		250	0	250	mm/s	
		TCH Hand Guide TCP Speed Limit		450	0	750	mm/s	
		End-Point Reduced Speed Limit		250	0	250	mm/s	
	Performance Safety	Speed Limit	Safety Tool		1500	0	4500	mm/s
			J1, J2		240	0	240	deg/s
			J3		240	0	240	deg/s
			J4, J5		260	0	260	deg/s
			J6		520	0	520	deg/s
		Force Limit	TCP, Elbow		150	100	450	N
		Torque Limit	J1, J2		85000	30000	170000	mNm
			J3		85000	30000	170000	mNm
	J4		23000	8000	45000	mNm		
	J5, J6		23000	8000	45000	mNm		
	Human-Machine Safety	Speed Limit	Safety Tool		Vary from the Body Region selected.	0	4500	mm/s
			J1-J6		Default, Min. and Max. Values are the same as Performance Safety			
Force Limit		TCP, Elbow		Default, Min. and Max. Values are the same as Performance Safety				
Torque Limit		J1, J2		65000	30000	170000	mNm	
		J3		65000	30000	170000	mNm	
		J4		15000	8000	45000	mNm	
	J5, J6		15000	8000	45000	mNm		
Soft Axis	Default / Additional	Joint Position	J1, J2, J4, J5, J6		-	-360	360	deg
			J3		-	-158	158	deg
		Cartesian Limit A Cartesian Limit B	X, Y, Z		-	-3000	3000	mm
			$\theta_z$		-	0	359	deg
			R		-	60	3000	mm
Safety IO	Input Functions	Input Discrepancy Detection Time	Emergency Stop, Safeguard Safeguard for Human-Machine Safety, Reset, Mode Switch, Soft Axis Switch, Bumping Sensor		20	0	1000	ms
			Enabling Switch		500	0	1000	ms
	Output Functions	Safe Home	J1-J6 Position		0	-360	360	deg
			Joint Position Tolerance		1	1	3	deg
Safety Tool Point	Safety Tool Point	Basic	X, Y, Z		0	-900	900	mm
		Advance	X, Y, Z		0	-900	900	mm
Mounting Direction	Gravity Direction	$\alpha$		90	0	180	deg	
		$\beta$		90	0	180	deg	
		$\gamma$		180	0	180	deg	

## TM12S Series

				Default Value	Min. Value	Max. Value	Unit	
Speed & Force	General	T1 Hand Guide TCP Speed Limit		250	0	250	mm/s	
		TCH Hand Guide TCP Speed Limit		450	0	750	mm/s	
		End-Point Reduced Speed Limit		250	0	250	mm/s	
	Performance Safety	Speed Limit	Safety Tool		1500	0	4500	mm/s
			J1, J2		160	0	160	deg/s
			J3		240	0	240	deg/s
			J4, J5		260	0	260	deg/s
			J6		520	0	520	deg/s
		Force Limit	TCP, Elbow		150	100	450	N
		Torque Limit	J1, J2		175000	30000	350000	mNm
			J3		85000	30000	170000	mNm
	J4		23000	8000	45000	mNm		
	J5, J6		23000	8000	45000	mNm		
	Human-Machine Safety	Speed Limit	Safety Tool		Vary from the Body Region selected.	0	4500	mm/s
			J1-J6		Default, Min. and Max. Values are the same as Performance Safety			
		Force Limit	TCP, Elbow					
Torque Limit		J1, J2		65000	30000	350000	mNm	
		J3		65000	30000	170000	mNm	
		J4		15000	8000	45000	mNm	
	J5, J6		15000	8000	45000	mNm		
Soft Axis	Default / Additional	Joint Position	J1, J2, J4, J5, J6		-	-360	360	deg
			J3		-	-162	162	deg
		Cartesian Limit A Cartesian Limit B	X, Y, Z		-	-3000	3000	mm
			$\theta_z$		-	0	359	deg
			R		-	60	3000	mm
Safety IO	Input Functions	Input Discrepancy Detection Time	Emergency Stop, Safeguard Safeguard for Human-Machine Safety, Reset, Mode Switch, Soft Axis Switch, Bumping Sensor		20	0	1000	ms
			Enabling Switch		500	0	1000	ms
	Output Functions	Safe Home	J1-J6 Position		0	-360	360	deg
			Joint Position Tolerance		1	1	3	deg
Safety Tool Point	Safety Tool Point	Basic	X, Y, Z		0	-1300	1300	mm
		Advance	X, Y, Z		0	-1300	1300	mm
Mounting Direction	Gravity Direction	$\alpha$		90	0	180	deg	
		$\beta$		90	0	180	deg	
		$\gamma$		180	0	180	deg	

## TM14S Series

				Default Value	Min. Value	Max. Value	Unit	
Speed & Force	General	T1 Hand Guide TCP Speed Limit		250	0	250	mm/s	
		TCH Hand Guide TCP Speed Limit		450	0	750	mm/s	
		End-Point Reduced Speed Limit		250	0	250	mm/s	
	Performance Safety	Speed Limit	Safety Tool		1500	0	4500	mm/s
			J1, J2		160	0	160	deg/s
			J3		240	0	240	deg/s
			J4, J5		260	0	260	deg/s
			J6		520	0	520	deg/s
		Force Limit	TCP, Elbow		150	100	450	N
		Torque Limit	J1, J2		175000	30000	350000	mNm
			J3		85000	30000	170000	mNm
	J4		23000	8000	45000	mNm		
	J5, J6		23000	8000	45000	mNm		
	Human-Machine Safety	Speed Limit	Safety Tool		Vary from the Body Region selected.	0	4500	mm/s
			J1-J6		Default, Min. and Max. Values are the same as Performance Safety			
		Force Limit	TCP, Elbow					
		Torque Limit	J1, J2		65000	30000	350000	mNm
J3			65000	30000	170000	mNm		
J4			15000	8000	45000	mNm		
J5, J6			15000	8000	45000	mNm		
Soft Axis	Default / Additional	Joint Position	J1, J2, J4, J5, J6		-	-360	360	deg
			J3		-	-163	163	deg
		Cartesian Limit A Cartesian Limit B	X, Y, Z		-	-3000	3000	mm
			$\theta_z$		-	0	359	deg
			R		-	60	3000	mm
Safety IO	Input Functions	Input Discrepancy Detection Time	Emergency Stop, Safeguard Safeguard for Human-Machine Safety, Reset, Mode Switch, Soft Axis Switch, Bumping Sensor		20	0	1000	ms
			Enabling Switch		500	0	1000	ms
	Output Functions	Safe Home	J1-J6 Position		0	-360	360	deg
			Joint Position Tolerance		1	1	3	deg
Safety Tool Point	Safety Tool Point	Basic	X, Y, Z		0	-1100	1100	mm
		Advance	X, Y, Z		0	-1100	1100	mm
Mounting Direction	Gravity Direction	$\alpha$		90	0	180	deg	
		$\beta$		90	0	180	deg	
		$\gamma$		180	0	180	deg	

## Appendix C: Modbus List

Classify	Function Code	Signal Type	R/W	Note
Read coils	01	Digital Output	R	TMflow Modbus signal type and Modbus function code table.
Read discrete inputs	02	Digital Input	R	
Read holding registers	03	Register Output	R	
Read input registers	04	Register Input	R	
Write single coil	05	Digital Output	W	
Write single register	06	Register Output	W	
Write multiple coils	15	Digital Output	W	
Write multiple registers	16	Register Output	W	

Robot Status 1	FC	Address <sub>10</sub>	Type	R/W	Note	S series	HW 3.2
Robot Link	02	7200	Bool	R	0: No 1: Yes		
Error or Not	02	7201	Bool	R			
Get UI Control or Not	02	7205	Bool	R			
Light	01/05	7206	Bool	R/W	0: Disable 1: Enable		
User Connected External Safeguard [Pause]	02	7207	Bool	R	0: Restored 1: Triggered		
ESTOP	02	7208	Bool	R			
AUTO MODE play confirm port (AUT.P)	02	7214	Bool	R	0: Low 1: High (Able to play in auto mode)		X
Robot State	04	7215	Int16	R	0: Normal 1: SOS 2: Error 3: Recovery Mode 4: STO (Including ESTOP)		
Operation Mode	04	7216	Int16	R	0: Manual 1: Auto		
Manual Mode Settings	04	7217	Int16	R	0: T1 Setting 1: TCH Setting		X
Emergency Stop Output follow	04	7218	Int16	R	0: Robot Status 1: Input Status		X
Safeguard Output follow	04	7219	Int16	R			
Safeguard for Human-Machine Safety Settings Output follow	04	7220	Int16	R	0: Robot Status 1: Input Status (HW 3.2 not support)		
Remote Control Fieldbus Active (Robot Stick function)	02	7212	Bool	R	0: Inactive 1: Active		
Remote Control IO Active (Robot Stick function)	02	7213	Bool	R	0: Inactive 1: Active		

Note

**NOTE:**

Robot Stick Enable: Local Control. Robot Stick Disable: Remote Control (Refer to "FC: 04, Address 7157" for Robot Stick status.)

Robot Status 2	FC	Address <sub>10</sub>	Type	R/W	Note	S series	HW 3.2
Auto Remote Mode Enable or not	02	7209	Bool	R	Enable: 1 Disable: 0	X	
Auto Remote Mode Active	05	7210	Bool	W	Active: 1 Inactive: 0 (Need Get Control in Auto Mode)	X	
Auto Remote Mode Active	02	7210	Bool	R	Active: 1 Inactive: 0	X	

Project Status	FC	Address <sub>10</sub>	Type	R/W	Note	S series	HW 3.2
Project Running or Not	02	7202	Bool	R	0: No 1: Yes		
Project Editing or Not	02	7203	Bool	R			
Project Pause or Not	02	7204	Bool	R			

Control Box DI/O	FC	Address <sub>10</sub>	Type	R/W	Note	S series	HW 3.2
DO 0	01/05	0000	Bool	R/W	0: Low 1: High		
DO 1	01/05	0001	Bool	R/W			
DO 2	01/05	0002	Bool	R/W			
DO 3	01/05	0003	Bool	R/W			
DO 4	01/05	0004	Bool	R/W			
DO 5	01/05	0005	Bool	R/W			
DO 6	01/05	0006	Bool	R/W			
DO 7	01/05	0007	Bool	R/W			
DO 8	01/05	0008	Bool	R/W			
DO 9	01/05	0009	Bool	R/W			
DO 10	01/05	0010	Bool	R/W			
DO 11	01/05	0011	Bool	R/W			
DO 12	01/05	0012	Bool	R/W			
DO 13	01/05	0013	Bool	R/W			
DO 14	01/05	0014	Bool	R/W			
DO 15	01/05	0015	Bool	R/W			
DI 0	02	0000	Bool	R			
DI 1	02	0001	Bool	R			
DI 2	02	0002	Bool	R			
DI 3	02	0003	Bool	R			
DI 4	02	0004	Bool	R			
DI 5	02	0005	Bool	R			
DI 6	02	0006	Bool	R			

Control Box DI/O	FC	Address <sub>10</sub>	Type	R/W	Note	S series	HW 3.2
DI 7	02	0007	Bool	R			
DI 8	02	0008	Bool	R			
DI 9	02	0009	Bool	R			
DI 10	02	0010	Bool	R			
DI 11	02	0011	Bool	R			
DI 12	02	0012	Bool	R			
DI 13	02	0013	Bool	R			
DI 14	02	0014	Bool	R			
DI 15	02	0015	Bool	R			

End Module	FC	Address <sub>10</sub>	Type	R/W	Note	S series	HW 3.2
DI 0	02	0800	Bool	R	0: Low 1: High		
DI 1	02	0801	Bool	R			
DI 2	02	0802	Bool	R			
DI3	02	0803	Bool	R			
DO 0	01/05	0800	Bool	R/W			
DO 1	01/05	0801	Bool	R/W			
DO 2	01/05	0802	Bool	R/W			
DO 3	01/05	0803	Bool	R/W			
AI 0	04	0800~0801	Float	R			

Control Box AI/O	FC	Address <sub>10</sub>	Type	R/W	Note	S series	HW 3.2
AO 0	03/16	0000~0001	Float	R/W			
AO 1	03/16	0002~0003	Float	R/W			X
AI 0	04	0000~0001	Float	R			
AI 1	04	0002~0003	Float	R			

External Module	FC	Address <sub>10</sub>	Type	R/W	Note	S series	HW 3.2
AO	03/16	starting with 0900~0901 (Max:1698~1699)	Float	R/W			
AI	04	starting with 0900~0901 (Max:1698~1699)	Float	R			
DO	01/05	starting with 0900 (Max:1699)	Bool	R/W			
DI	02	starting with 0900 (Max:1699)	Bool	R			





**NOTE:**

$$(AIO\ Address_{10} = 0900 + 100 \times M + N \sim 0901 + 100 \times M + N)$$

$$(DIO\ Address_{10} = 0900 + 100 \times M + N)$$

- 0900 is the starting address for all external modules, and each module comes an interval of 100 between its starting address and the starting address of the other external modules.
- M = the external module number starting with 0.
- N = the number of the expansion I/Os on the external module starting with 0.

Supposed you have 2 external modules with 64 expansion I/Os on each. The external module numbers will be 0 and 1 respectively. The addresses in decimal of the first external module are ranging from 0900 to 0963, and the addresses in decimal of the second external module are ranging from 1000 to 1063.

Controller Safety Output Assign	FC	Address <sub>10</sub>	Type	R/W	Note	S series	HW 3.2
SO 0 Assign	04	0130	Int16	R	0: Not Using 1: SF2-Encoder Standstill Status Output 2: SF10-Robot ESTOP Output 3:SF11-User Connected External Safeguard Output 4: SF12-Robot Human-Machine Safety Settings Output 5: SF13-Robot Recovery Mode Output 6: SF14-Robot Moving Output 7: SF28-Enabling Switch Output 8: SF29-MODE Switch Output 9: SF30-Safe Home Output 10: SF31-Reset Output		
SO 1 Assign	04	0131	Int16	R			
SO 2 Assign	04	0132	Int16	R			
SO 3 Assign	04	0133	Int16	R			X
SO 4 Assign	04	0134	Int16	R			
SO 5 Assign	04	0135	Int16	R			X
SO 6 Assign	04	0136	Int16	R			X
SO 7 Assign	04	0137	Int16	R			X

Controller Safety Output	FC	Address <sub>10</sub>	Type	R/W	Note	S series	HW 3.2
SO 0	02	0100	Bool	R	0: Low (Include discrepancy) 1: High (HW 3.2 - SO3: Robot		
SO 1	02	0101	Bool	R			
SO 2	02	0102	Bool	R			
SO 3	02	0103	Bool	R			

SO 4	02	0104	Bool	R	Internal Protective Stop Output )		
SO 5	02	0105	Bool	R			X
SO 6	02	0106	Bool	R			X
SO 7	02	0107	Bool	R			X

Controller Safety Output OSSD	FC	Address <sub>10</sub>	Type	R/W	Note	S series	HW 3.2
SO 0	02	0160	Bool	R	0: Disable 1: Enable		X
SO 1	02	0161	Bool	R			
SO 2	02	0162	Bool	R			
SO 3	02	0163	Bool	R			
SO 4	02	0164	Bool	R			
SO 5	02	0165	Bool	R			
SO 6	02	0166	Bool	R			
SO 7	02	0167	Bool	R			

Controller Safety Input Assign	FC	Address <sub>10</sub>	Type	R/W	Note	S series	HW 3.2
SI 0 Assign [ES]	04	0230	Int16	R	0: Not Using 1: SF1-User Connected ESTOP Input 2: SF3-User Connected External Safeguard Input 3: SF9-User Connected External Safeguard Input 4: for Human-Machine Safety Settings 4: SF15-User Connected Enabling Switch Input* 5: SF16-User Connected ESTOP Input without Robot ESTOP Output 6: SF25-User Connected MODE Switch Input* 7: SF26-User Connected Reset Input* 8: SF27-User Connected Soft Axis Settings Switch Input 9: SF32-User Connected External Bumping Sensor Input		
SI 1 Assign [SFG]	04	0231	Int16	R			
SI 2 Assign	04	0232	Int16	R			
SI 3 Assign	04	0233	Int16	R			
SI 4 Assign	04	0234	Int16	R			
SI 5 Assign	04	0235	Int16	R			
SI 6 Assign	04	0236	Int16	R			
SI 7 Assign	04	0237	Int16	R			X

Controller Safety Input	FC	Address <sub>10</sub>	Type	R/W	Note	S series	HW 3.2
SI 0 [ES]	02	0200	Bool	R	0: Untriggered (Include discrepancy) 1: Triggered		
SI 1 [SFG]	02	0201	Bool	R			
SI 2	02	0202	Bool	R	0: Low (Include discrepancy) 1: High		
SI 3	02	0203	Bool	R			
SI 4	02	0204	Bool	R			
SI 5	02	0205	Bool	R			X
SI 6	02	0206	Bool	R			X
SI 7	02	0207	Bool	R			X

Robot Coordinate	FC	Address <sub>10</sub>	Type	R/W	Note	S series	HW 3.2
X (Cartesian coordinate w.r.t. current Base without tool)	04	7001~7002	Float	R	mm		
Y (Cartesian coordinate w.r.t. current Base without tool)	04	7003~7004	Float	R	mm		
Z (Cartesian coordinate w.r.t. current Base without tool)	04	7005~7006	Float	R	mm		
Rx (Cartesian coordinate w.r.t. current Base without tool)	04	7007~7008	Float	R	degree		
Ry (Cartesian coordinate w.r.t. current Base without tool)	04	7009~7010	Float	R	degree		
Rz (Cartesian coordinate w.r.t. current Base without tool)	04	7011~7012	Float	R	degree		
Joint 1	04	7013~7014	Float	R	degree		
Joint 2	04	7015~7016	Float	R	degree		
Joint 3	04	7017~7018	Float	R	degree		
Joint 4	04	7019~7020	Float	R	degree		
Joint 5	04	7021~7022	Float	R	degree		
Joint 6	04	7023~7024	Float	R	degree		
X (Cartesian coordinate w.r.t. current Base with tool)	04	7025~7026	Float	R	mm		
Y (Cartesian coordinate w.r.t. current Base with tool)	04	7027~7028	Float	R	mm		
Z (Cartesian coordinate w.r.t. current Base with tool)	04	7029~7030	Float	R	mm		
Rx (Cartesian coordinate w.r.t. current Base with tool)	04	7031~7032	Float	R	degree		
Ry (Cartesian coordinate w.r.t. current Base with tool)	04	7033~7034	Float	R	degree		
Rz (Cartesian coordinate w.r.t. current Base with tool)	04	7035~7036	Float	R	degree		
X (Cartesian coordinate w.r.t. Robot Base without tool)	04	7037~7038	Float	R	mm		
Y (Cartesian coordinate w.r.t. Robot Base without tool)	04	7039~7040	Float	R	mm		

Robot Coordinate	FC	Address <sub>10</sub>	Type	R/W	Note	S series	HW 3.2
Robot Base without tool)							
Z (Cartesian coordinate w.r.t. Robot Base without tool)	04	7041~7042	Float	R	mm		
Rx (Cartesian coordinate w.r.t. Robot Base without tool)	04	7043~7044	Float	R	degree		
Ry (Cartesian coordinate w.r.t. Robot Base without tool)	04	7045~7046	Float	R	degree		
Rz (Cartesian coordinate w.r.t. Robot Base without tool)	04	7047~7048	Float	R	degree		
X (Cartesian coordinate w.r.t. Robot Base with tool)	04	7049~7050	Float	R	mm		
Y (Cartesian coordinate w.r.t. Robot Base with tool)	04	7051~7052	Float	R	mm		
Z (Cartesian coordinate w.r.t. Robot Base with tool)	04	7053~7054	Float	R	mm		
Rx (Cartesian coordinate w.r.t. Robot Base with tool)	04	7055~7056	Float	R	degree		
Ry (Cartesian coordinate w.r.t. Robot Base with tool)	04	7057~7058	Float	R	degree		
Rz (Cartesian coordinate w.r.t. Robot Base with tool)	04	7059~7060	Float	R	degree		

Robot Coordinate (When touchstop node be triggered)	FC	Address <sub>10</sub>	Type	R/W	Note	S series	HW 3.2
X (Cartesian coordinate w.r.t. current Base without tool)	04	7401~7402	Float	R	mm		
Y (Cartesian coordinate w.r.t. current Base without tool)	04	7403~7404	Float	R	mm		
Z (Cartesian coordinate w.r.t. current Base without tool)	04	7405~7406	Float	R	mm		
Rx (Cartesian coordinate w.r.t. current Base without tool)	04	7407~7408	Float	R	degree		
Ry (Cartesian coordinate w.r.t. current Base without tool)	04	7409~7410	Float	R	degree		
Rz (Cartesian coordinate w.r.t. current Base without tool)	04	7411~7412	Float	R	degree		
Joint 1	04	7413~7414	Float	R	degree		
Joint 2	04	7415~7416	Float	R	degree		
Joint 3	04	7417~7418	Float	R	degree		
Joint 4	04	7419~7420	Float	R	degree		
Joint 5	04	7421~7422	Float	R	degree		
Joint 6	04	7423~7424	Float	R	degree		
X (Cartesian coordinate w.r.t. current Base with tool)	04	7425~7426	Float	R	mm		

Robot Coordinate (When touchstop node be triggered)	FC	Address <sub>10</sub>	Type	R/W	Note	S series	HW 3.2
Y (Cartesian coordinate w.r.t. current Base with tool)	04	7427~7428	Float	R	mm		
Z (Cartesian coordinate w.r.t. current Base with tool)	04	7429~7430	Float	R	mm		
Rx (Cartesian coordinate w.r.t. current Base with tool)	04	7431~7432	Float	R	degree		
Ry (Cartesian coordinate w.r.t. current Base with tool)	04	7433~7434	Float	R	degree		
Rz (Cartesian coordinate w.r.t. current Base with tool)	04	7435~7436	Float	R	degree		
X (Cartesian coordinate w.r.t. Robot Base without tool)	04	7437~7438	Float	R	mm		
Y (Cartesian coordinate w.r.t. Robot Base without tool)	04	7439~7440	Float	R	mm		
Z (Cartesian coordinate w.r.t. Robot Base without tool)	04	7441~7442	Float	R	mm		
Rx (Cartesian coordinate w.r.t. Robot Base without tool)	04	7443~7444	Float	R	degree		
Ry (Cartesian coordinate w.r.t. Robot Base without tool)	04	7445~7446	Float	R	degree		
Rz (Cartesian coordinate w.r.t. Robot Base without tool)	04	7447~7448	Float	R	degree		
X (Cartesian coordinate w.r.t. Robot Base with tool)	04	7449~7450	Float	R	mm		
Y (Cartesian coordinate w.r.t. Robot Base with tool)	04	7451~7452	Float	R	mm		
Z (Cartesian coordinate w.r.t. Robot Base with tool)	04	7453~7454	Float	R	mm		
Rx (Cartesian coordinate w.r.t. Robot Base with tool)	04	7455~7456	Float	R	degree		
Ry (Cartesian coordinate w.r.t. Robot Base with tool)	04	7457~7458	Float	R	degree		
Rz (Cartesian coordinate w.r.t. Robot Base with tool)	04	7459~7460	Float	R	degree		

Note

**NOTE:**

When the field of Record Stopping Position on POINT in the touch stop node is not empty, it writes the corresponding coordinate values of the dynamic point to the Modbus addresses.

Run Setting	FC	Address <sub>10</sub>	Type	R/W	Note	S series	HW 3.2
Current Project	04	7701~7799	String	R	Use \0 to mark the end of the string.		

Change Current Project	06/16	7701~7799	String	W	(Auto Mode and project is not running)		
------------------------	-------	-----------	--------	---	--	--	--



**NOTE:**

- Robot Stick Enable: Local Control ; Robot Stick Disable: Remote Control (Robot Stick status can refer to "FC: 04, Address 7157")
- Use \0 as the suffix for the ending symbol such as TMflow\0 for the project named TMflow. The \0 denotes 0x00 but not 0x5C 0x30.
- The write command is available only when in Remote Control and the robot is inactive.

TCP Value	FC	Address <sub>10</sub>	Type	R/W	Note	S series	HW 3.2
X (TCP Value)	04	7354~7355	Float	R	mm		
Y (TCP Value)	04	7356~7357	Float	R	mm		
Z (TCP Value)	04	7358~7359	Float	R	mm		
RX (TCP Value)	04	7360~7361	Float	R	degree		
RY (TCP Value)	04	7362~7363	Float	R	degree		
RZ (TCP Value)	04	7364~7365	Float	R	degree		
Mass (TCP Value)	04	7366~7367	Float	R	Kg		
Ixx (Principal moments of inertia)	04	7368~7369	Float	R	Kg·mm <sup>2</sup>		
Iyy (Principal moments of inertia)	04	7370~7371	Float	R	Kg·mm <sup>2</sup>		
Izz (Principal moments of inertia)	04	7372~7373	Float	R	Kg·mm <sup>2</sup>		
X (Mass center frames with principal axes w.r.t the robot end flange frame)	04	7374~7375	Float	R	mm		
Y (Mass center frames with principal axes w.r.t the robot end flange frame)	04	7376~7377	Float	R	mm		
Z (Mass center frames with principal axes w.r.t the robot end flange frame)	04	7378~7379	Float	R	mm		
RX (Mass center frames with principal axes w.r.t the robot end flange frame)	04	7380~7381	Float	R	degree		
RY (Mass center frames with principal axes w.r.t the robot end flange frame)	04	7382~7383	Float	R	degree		
RZ (Mass center frames with principal axes w.r.t the robot end flange frame)	04	7384~7385	Float	R	degree		

Robot Stick	FC	Address <sub>10</sub>	Type	R/W	Note	S series	HW 3.2
M/A Mode	04	7102	Int16	R	A:1; M:2		

Play/Pause	05	7104	Bool	W	Triggered as 1 received (Toggle).		
Stop	05	7105	Bool	W	Triggered as 1 received.		
+	05	7106	Bool	W			
-	05	7107	Bool	W			
Play	05	7103	Bool	W			
Pause	05	7108	Bool	W			

Project Speed	FC	Address <sub>10</sub>	Type	R/W	Note	S series	HW 3.2
Project Speed	04	7101	Int16	R	%		
Change Project Speed	06	7101	Int16	W	% (Remote Control only) Project speed can only be written multiples of five. (5 ≤ Project Speed ≤ 100)		



**NOTE:**

- Robot Stick Enable: Local Control ; Robot Stick Disable: Remote Control ( Refer to "FC: 04, Address 7157" for Robot Stick status.)
- Refer to "FC: 02, Address 7216" for Remote Control Fieldbus Active.
- Play, Pause, Stop, +, - and Change Project Speed can only be written in the following situation.
- In auto mode, the project can only be played while "AUTO MODE play confirm port (AUT.P)" input high and. (AUTO MODE play confirm port (AUT.P) can refer to "FC: 02, Address 7209")
- If Enabling Switch Input status is low in Manual Mode, the project will be paused. (Enabling Switch Input Status can refer to "FC: 02, Address 7159")

Status	The following functions can be used	
	Local Controller Fieldbus	External Fieldbus
Local Control	Play Pause Stop	N/A
Remote Control (Remote Control of fieldbus is active)	+ - Change Project Speed	Play Pause Stop + - Change Project Speed

Robot Stick Status (Pressed)	FC	Address <sub>10</sub>	Type	R/W	Note	S series	HW 3.2
M/A	02	7151	Bool	R	0: Release 1: Pressed		
Play/Pause	02	7152	Bool	R	0: Release 1: Pressed	X	
Stop	02	7153	Bool	R	0: Release 1: Pressed		
+	02	7154	Bool	R			
-	02	7155	Bool	R			
Play	02	7149	Bool	R	0: Release 1: Pressed		X
Pause	02	7156	Bool	R			

Robot Stick Status	FC	Address <sub>10</sub>	Type	R/W	Note	S series	HW 3.2
Enable/Disable of Robot Stick Status	02	7157	Bool	R	0: Disable 1: Enable		X
ESTOP Input Status	02	7158	Bool	R	0: Low 1: High		X
Enabling Switch Input Status	02	7159	Bool	R	0: Low 1: High		X
Reset Input Status	02	7160	Bool	R	0: Low 1: High		X

End module button (Pressed)	FC	Address <sub>10</sub>	Type	R/W	Note	S series	HW 3.2
Enabling Switch Status	02	7170	Bool	R	0: Release 1: Pressed		

TCP Speed	FC	Address <sub>10</sub>	Type	R/W	Note	S series	HW 3.2
X	04	7859~7860	Float	R	mm/s		
Y	04	7861~7862	Float	R	mm/s		
Z	04	7863~7864	Float	R	mm/s		
RX	04	7865~7866	Float	R	degree/s		
RY	04	7867~7868	Float	R	degree/s		
RZ	04	7869~7870	Float	R	degree/s		
TCP Speed	04	7871~7872	Float	R	mm/s (According to current tool) $S_{3D} = \sqrt{S_x^2 + S_y^2 + S_z^2}$		

TCP Force	FC	Address <sub>10</sub>	Type	R/W	Note	S series	HW 3.2
FX	04	7801~7802	Float	R	N		
FY	04	7803~7804	Float	R	N		
FZ	04	7805~7806	Float	R	N		
F3D	04	7807~7808	Float	R	N		



Joint Torque (Raw Data)	FC	Address <sub>10</sub>	Type	R/W	Note	S series	HW 3.2
Joint 1	04	7847~7848	Float	R	mNm		
Joint 2	04	7849~7850	Float	R	mNm		
Joint 3	04	7851~7852	Float	R	mNm		
Joint 4	04	7853~7854	Float	R	mNm		
Joint 5	04	7855~7856	Float	R	mNm		
Joint 6	04	7857~7858	Float	R	mNm		

Joint Torque (Raw Data) (Average value within 40 ms)	FC	Address <sub>10</sub>	Type	R/W	Note	S series	HW 3.2
Joint 1	04	7877~7878	Float	R	mNm		
Joint 2	04	7879~7880	Float	R	mNm		
Joint 3	04	7881~7882	Float	R	mNm		
Joint 4	04	7883~7884	Float	R	mNm		
Joint 5	04	7885~7886	Float	R	mNm		
Joint 6	04	7887~7888	Float	R	mNm		

Joint Torque (Raw Data) (Min value in 40 ms)	FC	Address <sub>10</sub>	Type	R/W	Note	S series	HW 3.2
Joint 1	04	7889~7890	Float	R	mNm		
Joint 2	04	7891~7892	Float	R	mNm		
Joint 3	04	7893~7894	Float	R	mNm		
Joint 4	04	7895~7896	Float	R	mNm		
Joint 5	04	7897~7898	Float	R	mNm		
Joint 6	04	7899~7900	Float	R	mNm		

Joint Torque (Raw Data) (Max value in 40 ms)	FC	Address <sub>10</sub>	Type	R/W	Note	S series	HW 3.2
Joint 1	04	7901~7902	Float	R	mNm		
Joint 2	04	7903~7904	Float	R	mNm		
Joint 3	04	7905~7906	Float	R	mNm		
Joint 4	04	7907~7908	Float	R	mNm		
Joint 5	04	7909~7910	Float	R	mNm		
Joint 6	04	7911~7912	Float	R	mNm		

Joint Torque (Estimated Data)	FC	Address <sub>10</sub>	Type	R/W	Note	S series	HW 3.2
Joint 1	04	7949~7950	Float	R	mNm		
Joint 2	04	7951~7952	Float	R	mNm		
Joint 3	04	7953~7954	Float	R	mNm		
Joint 4	04	7955~7956	Float	R	mNm		
Joint 5	04	7957~7958	Float	R	mNm		
Joint 6	04	7959~7960	Float	R	mNm		

Joint Speed	FC	Address <sub>10</sub>	Type	R/W	Note	S series	HW 3.2
Joint 1	04	7913~7914	Float	R	degree/s		
Joint 2	04	7915~7916	Float	R	degree/s		
Joint 3	04	7917~7918	Float	R	degree/s		
Joint 4	04	7919~7920	Float	R	degree/s		
Joint 5	04	7921~7922	Float	R	degree/s		
Joint 6	04	7923~7924	Float	R	degree/s		

Joint Current	FC	Address <sub>10</sub>	Type	R/W	Note	S series	HW 3.2
Joint 1	04	7925~7926	Float	R	mA		
Joint 2	04	7927~7928	Float	R	mA		
Joint 3	04	7929~7930	Float	R	mA		
Joint 4	04	7931~7932	Float	R	mA		
Joint 5	04	7933~7934	Float	R	mA		
Joint 6	04	7935~7936	Float	R	mA		

Joint Temperature	FC	Address <sub>10</sub>	Type	R/W	Note	S series	HW 3.2
Joint 1	04	7937~7938	Float	R	Celsius		
Joint 2	04	7939~7940	Float	R	Celsius		
Joint 3	04	7941~7942	Float	R	Celsius		
Joint 4	04	7943~7944	Float	R	Celsius		
Joint 5	04	7945~7946	Float	R	Celsius		
Joint 6	04	7947~7948	Float	R	Celsius		

Current Base	FC	Address <sub>10</sub>	Type	R/W	Note	S series	HW 3.2
X	04	8300~8301	Float	R	mm		
Y	04	8302~8303	Float	R	mm		
Z	04	8304~8305	Float	R	mm		
RX	04	8306~8307	Float	R	degree		
RY	04	8308~8309	Float	R	degree		
RZ	04	8310~8311	Float	R	degree		

Running Timer	FC	Address <sub>10</sub>	Type	R/W	Note	S series	HW 3.2
Day	04	8200~8201	Int32	R	Current project running time. (If the project is stopped, it will return to 0.)		
Hour	04	8202	Int16	R			
Minute	04	8203	Int16	R			
Second	04	8204	Int16	R			

Up Time	FC	Address <sub>10</sub>	Type	R/W	Note	S series	HW 3.2
Day	04	8206~8207	Int32	R	Time elapsed since the controller was started		
Hour	04	8208	Int16	R			
Minute	04	8209	Int16	R			
Second	04	8210	Int16	R			

Safety Setting	FC	Address <sub>10</sub>	Type	R/W	Note	S series	HW 3.2
Safety System Version	04	7280~7289	String	R			
Safety Checksum	04	7290~7299	String	R			

Others 1	FC	Address <sub>10</sub>	Type	R/W	Note	S series	HW 3.2
Current Time: Year	04	7301	Int16	R			
Current Time: Month	04	7302	Int16	R			
Current Time: Date	04	7303	Int16	R			
Current Time: Hour	04	7304	Int16	R			
Current Time: Minute	04	7305	Int16	R			
Current Time: Second	04	7306	Int16	R			
HMI Version	04	7308~7312	String	R			
Last Error Code	04	7320~7321	Int32	R			
Last Error Time: Year	04	7322	Int16	R			
Last Error Time: Month	04	7323	Int16	R			
Last Error Time: Date	04	7324	Int16	R			
Last Error Time: Hour	04	7325	Int16	R			
Last Error Time: Minute	04	7326	Int16	R			
Last Error Time: Second	04	7327	Int16	R			
Control Box Serial Number	04	7561~7570	String	R			
Robot Model	04	7571~7579	String	R			

Others 2	FC	Address <sub>10</sub>	Type	R/W	Note	S series	HW 3.2
Controller Temperature	04	7340~7341	Float	R	Celsius		
Robot Voltage	04	7342~7343	Float	R	Voltage		
Robot Power Consumption	04	7344~7345	Float	R	Watt		
Robot Current	04	7346~7347	Float	R	A		
Control Box IO Current	04	7348~7349	Float	R	mA		
End Module IO Current	04	7350~7351	Float	R	mA		

Others 3	FC	Address <sub>10</sub>	Type	R/W	Note		
Robot Light	04	7332	Int16	R	<p>0: Light off, when robot power off or STO state.</p> <p>1: Solid Red, fatal error.</p> <p>2: Flashing Red, Robot is initializing.</p> <p>3: Solid Blue, standby in Auto Mode.(HW3.2)</p> <p>4: Flashing Blue, in Auto Mode.(HW3.2)</p> <p>5: Solid Green, standby in Manual Mode.</p> <p>6: Flashing Green, in Manual Mode.</p> <p>9: Alternating Blue&amp;Red, Auto Mode error. (HW3.2)</p> <p>10: Alternating Green&amp;Red, Manual Mode error.</p> <p>13: Alternating Green&amp;Purple, in Manual Mode (Safeguard Port B trigger).</p> <p>14 Alternating Blue&amp;Purple, in Auto Mode (Safeguard Port B trigger).(HW3.2)</p> <p>17. Alternating Green&amp;White, in Manual Mode &amp; Maintenance mode. (HW3.2)</p> <p>18: Alternating White&amp;Blue, in Auto Mode &amp; Maintenance mode.</p> <p>19: Flashing light blue, representing that it enters the Safe Startup Mode.</p> <p>20: Solid White, standby in Auto Mode.(S Series)</p> <p>21: Flashing White, in Auto Mode. (S Series)</p>		

					22: Alternating White&Red, Auto Mode error. (S Series) 23: Alternating White&Purple, in Auto Mode (Safeguard Port B trigger).(S Series) 24: Alternating White&Yellow, in Auto Mode & Recovery mode. 25: Alternating Green&Yellow, in Manual Mode & Recovery mode. 26: Alternating Green&Blue, in Manual Mode & Maintenance mode. (S Series)		
--	--	--	--	--	---	--	--

Others 4	FC	Address <sub>10</sub>	Type	R/W	Note	S series	HW 3.2
User Define Area	01/03/05/06	9000~9999	User-define	R/W			

## Appendix D: Ethernet Slave Data Table

Item Name (ID)	Description	Type	Size	*A	**W	Note	S series	HW 3.2
Get_UI_Control	Get Control or Not	bool	1	R		Yes:1 No: 0		
Robot_Error	Error or Not	bool	1	R		Yes:1 No: 0		
Error_Code	Last Error Code	int	1	R		Format: Hexadecimal		
Error_Time	Last Error Time	string	1	R		Format: [YYYY]-[MM]-[DD]T[hh]:[mm]:[ss.sss]		
Camera_Light	Light	byte	1	R/W	M/A	Enable: 1 Disable: 0		
Project_Speed	Project Running Speed	byte	1	R/W	M/A	Unit: % Project speed can only be written multiples of five. (5≤Project Speed≤100) *Refer to Safety Manual for details		
Project_Name	Project Name	string	1	R/W	A	*Refer to Safety Manual for details		
Project_Run_Time	Project Running Time	string	1	R		Format: [days].[hh]:[mm]:[ss.sss]		
Project_Run	Project Running or Not	bool	1	R		Yes:1 No: 0		
Project_Edit	Project Editing or Not	bool	1	R		Yes:1 No: 0		
Project_Pause	Project Pause or Not	bool	1	R		Yes:1 No: 0		
Coord_Base_Flange	Cartesian coordinate w.r.t. current Base without tool	float	6	R		Unit: mm, deg		
Joint_Angle	Joint 1 angle - Joint 6 angle	float	6	R		Unit: degree		
Coord_Base_Tool	Cartesian coordinate w.r.t. current Base with tool	float	6	R		Unit: mm, deg		
Coord_Robot_Flange	Cartesian coordinate w.r.t. Robot Base without tool	float	6	R		Unit: mm, deg		
Coord_Robot_Tool	Cartesian coordinate w.r.t. Robot Base with tool	float	6	R		Unit: mm, deg		
Touch_Coord_Base_Flange	Cartesian coordinate w.r.t. current Base without tool (When touchstop node be triggered)	float	6	R		Unit: mm, deg		
Touch_Joint_Angle_Stop	Joint 1 angle - Joint 6 angle (When touchstop node be triggered)	float	6	R		Unit: degree		
Touch_Coord_Base_Tool	Cartesian coordinate w.r.t. current Base with tool (When touchstop node be triggered)	float	6	R		Unit: mm, deg		
Touch_Coord_Robot_Flange	Cartesian coordinate w.r.t. Robot Base without tool (When touchstop node be triggered)	float	6	R		Unit: mm, deg		
Touch_Coord_Robot_Tool	Cartesian coordinate w.r.t. Robot Base with tool (When touchstop node be triggered)	float	6	R		Unit: mm, deg		
TCP_Force	Tool Force FX,FY,FZ	float	3	R		Unit: N		
TCP_Force3D	Tool Force FX,FY,FZ 3D	float	1	R		Unit: N		
TCP_Speed	Tool Speed X,Y,Z,RX,RY,RZ	float	6	R		Unit: mm/s, deg/s		
TCP_Speed3D	Tool Speed X,Y,Z 3D	float	1	R		Unit: mm/s		
Joint_Speed	Joint Speed	float	6	R		Unit: deg/s		
Joint_Torque	Joint Torque 1 - 6	float	6	R		Unit: mNm		
Joint_Torque_EST	Joint Torque 1 - 6 (Estimated Data)	float	6	R		Unit: mNm		
Joint_Torque_Average	Joint Torque 1 - 6 (Average in 40ms)	float	6	R		Unit: mNm		

Item Name (ID)	Description	Type	Size	*A	**W	Note	S series	HW 3.2
Joint_Torque_Min	Joint Torque 1 - 6 (Min. in 40ms)	float	6	R		Unit: mNm		
Joint_Torque_Max	Joint Torque 1 - 6 (Max. in 40ms)	float	6	R		Unit: mNm		
Joint_Current	Current of Each Joint	float	6	R		Unit: mA		
Joint_Temperature	Temperature of Each Joint	float	6	R		Unit: Celsius		
TCP_Name	TCP Name	string	1	R				
TCP_Value	TCP Value	float	6	R		Unit: mm, deg		
TCP_Mass	Mass (TCP Value)	float	1	R		Unit: kg		
TCP_MOI	Ixx, Iyy, Izz (Principal moments of inertia)	float	3	R		Unit: mm-kg		
TCP_MCF	Mass center frames with principal axes w.r.t. the robot end of flange frame	float	6	R		Unit: mm, deg		
Base_Name	Base Name	string	1	R				
Base_Value	Base Value	float	6	R		Unit: mm, deg		
HandCamera_Value	HandCamera TCP Value	float	6	R		Unit: mm, deg		
Stick_MA	Stick: M/A Button Status	bool	1	R		Pressed: 1, Released: 0		
Stick_Play	Stick: Play Button Status/Command	bool	1	R/W	M/A	R: Pressed: 1, Released: 0 W: Triggered as 1 received *Refer to Safety Manual for details		X (R)
Stick_Stop	Stick: Stop Button Status/Command	bool	1	R/W	M/A	R: Pressed: 1, Released: 0 W: Triggered as 1 received *Refer to Safety Manual for details		
Stick_Plus	Stick: Stick+ Button Status/Command	bool	1	R/W	M/A	R: Pressed: 1, Released: 0 W: Triggered as 1 received *Refer to Safety Manual for details		
Stick_Minus	Stick: Stick- Button Status/Command	bool	1	R/W	M/A	R: Pressed: 1, Released: 0 W: Triggered as 1 received *Refer to Safety Manual for details		
Stick_Pause	Stick: Pause Button Status/Command	bool	1	R/W	M/A	R: Pressed: 1, Released: 0 W: Triggered as 1 received *Refer to Safety Manual for details		X (R)
Stick_PlayPause	Stick: Play/Pause Button Status/Command	bool	1	R/W	M/A	Read: Pressed:1, Released:0 Write: Triggered as 1 received (Toggle) *Refer to safety manual for detail	X (R)	
Stick_Enable	Stick: Enable/Disable	bool	1	R		Disable: 0, Enable: 1		X
Stick_ESTOP	Stick: Emergency Stop Button Status	bool	1	R		Pressed: 1, Released: 0		X
Stick_EnablingSwitch	Stick: Enabling Switch Button Status	bool	1	R		Pressed: 1, Released: 0		X
Stick_Reset	Stick: Reset Button Status	bool	1	R		Pressed: 1, Released: 0		X
End_EnablingSwitch	EndModule: Enabling Switch Button status	bool	1	R		Pressed: 1, Released: 0		
Robot_Model	Robot Model	string	1	R				
ControlBox_SN	Serial Number of Control Box	float	1	R				
Controller_Temperature	Controller Temperature	float	1	R		Unit: Celsius		
Manipulator_Voltage	Voltage consumed by robot arm	float	1	R		Unit: Voltage		
Manipulator_Consumption	Power consumed by robot arm	float	1	R		Unit: Watt		
Manipulator_Current	Current consumed by robot arm	float	1	R		Unit: Ampere		

Item Name (ID)	Description	Type	Size	*A	**W	Note	S series	HW 3.2
ControlBox_IO_Current	Total Current output of Controlbox IO Ports	float	1	R		Unit: mA		
End_IO_Current	Total Current output of End Module IO Ports	float	1	R		Unit: mA		
Current_Time	Current Time	string	1	R		Format: [YYYY]-[MM]-[DD]T[hh]:[mm]:[ss.sss]		
System_Uptime	System Uptime	string	1	R		Format: [days].[hh]:[mm]:[ss.sss]		
TMflow_Version	TMflow Version	string	1	R		Format: X.XX.XXXX		
DHTable	DHTable { theta1, alpha1, a1, d1, joint_type1, lower_bound1, upper_bound1; theta2, alpha2, ..., upper_bound6 } forms a 7x6 matrix	float	42	R		Unit: mm   deg joint_type: always 0		
DeltaDH	DeltaDH Format: { d_theta1, d_alpha1, d_a1, d_d1, d_beta1; d_theta2, d_alpha2, ..., d_beta6 } forms a 5x6 matrix	float	30	R		Unit: mm   deg d_XXX: delta value of relative item in DHTable. d_beta: delta value of rotation angle at y axis of relative joint coordinate.		



Item Name (ID)	Description	Type	Size	*A	**W	Note	S series	HW 3.2
Robot_Light	Robot Light	byte	1	R		0: Light off, when robot power off or STO state. 1: Solid Red, fatal error. 2: Flashing Red, Robot is initializing. 3: Solid Blue, standby in Auto Mode.(HW3.2) 4: Flashing Blue, in Auto Mode.(HW3.2) 5: Solid Green, standby in Manual Mode. 6: Flashing Green, in Manual Mode. 9: Alternating Blue&Red, Auto Mode error. (HW3.2) 10: Alternating Green&Red, Manual Mode error. 13: Alternating Green&Purple, in Manual Mode (Safeguard Port B trigger). 14 Alternating Blue&Purple, in Auto Mode (Safeguard Port B trigger).(HW3.2) 17. Alternating Green&White, in Manual Mode & Maintenance mode. (HW3.2) 18: Alternating White&Blue, in Auto Mode & Maintenance mode. 19: Flashing light blue, representing that it enters the Safe Startup Mode. 20: Solid White, standby in Auto Mode.(S Series) 21: Flashing White, in Auto Mode. (S Series) 22: Alternating White&Red, Auto Mode error. (S Series) 23: Alternating White&Purple, in Auto Mode (Safeguard Port B trigger).(S Series) 24: Alternating White&Yellow, in Auto Mode & Recovery mode. 25: Alternating Green&Yellow, in Manual Mode & Recovery mode. 26: Alternating Green&Blue, in Manual Mode & Maintenance mode. (S Series)		
ESTOP	Emergency Stop	bool	1	R		Triggered: 1 Restored: 0		
Ext_Safeguard	User Connected External Safeguard [Pause]	bool	1	R		Triggered: 1 Restored: 0		
AUT_P	AUTO MODE play confirm port (AUT.P)	bool	1	R		0: Low 1: High (able to play)		X
Robot_State	Robot State	byte	1	R		0: Normal 1: SOS 2: Recovery Mode 3: Error 4: STO (Including ESTOP)		
Operation_Mode	Operation Mode	int	1	R		0: Manual 1: Auto		
Safety_Version	Safety System Version	string	1	R				
Safety_Checksum	Safety Settings Checksum	string	1	R				

Item Name (ID)	Description	Type	Size	*A	**W	Note	S series	HW 3.2
Manual_Mode_Settings	Safety Setting: Manual Mode Settings	int	1	R		0: T1 Setting 1: TCH Setting		X
ESTOP_output_follow	Safety Setting: Output behavior of ESTOP output	int	1	R		0: Robot Status 1: Input Status		X
Safeguard_output_follow	Safety Setting: Output behavior of Safeguard output	int	1	R		0: Robot Status 1: Input Status		X
HMSS_output_follow	Safety Setting: Output behavior of HMSS Safeguard output	int	1	R		0: Robot Status 1: Input Status		X
Auto_Remote_Enable	Auto Remote Mode Enable/Disable	bool	1	R		Parameter on System Page. Enable: 1 Disable: 0 *Refer to safety manual for detail	X	
Auto_Remote_Active	Auto Remote Mode Active/Inactive	bool	1	R/W	A	Active: 1 Inactive: 0 *Refer to safety manual for detail	X	
Remote_Ctrl_Fieldbus	Remote Control Fieldbus Active	bool	1	R		0: Inactive 1: Active		
Remote_Ctrl_IO	Remote Control IO Active	bool	1	R		0: Inactive 1: Active		
SO_Assign	Safety output #? function assignment	byte	8	R		0: Not Using 1: SF2-Encoder Standstill Status Output 2: SF10-Robot ESTOP Output 3: SF11-User Connected External Safeguard Output 4: SF12-Robot Human-Machine Safety Settings Output 5: SF13-Robot Recovery Mode Output 6: SF14-Robot Moving Output 7: SF28-Enabling Switch Output 8: SF29-MODE Switch Output 9: SF30-Safe Home Output 10: SF31-Reset Output		X (SO3, 5~7)
SO_OSSD	Enable/Disable of Safety output #? OSSD function	bool	8	R		0: Disable 1: Enable		X
SO	Safety output #? status	byte	8	R		0: Low 1: High (HW 3.2 - SO[3]: Robot Internal Protective Stop Output )		X (SO5 ~7)

Item Name (ID)	Description	Type	Size	*A	**W	Note	S series	HW 3.2
SI_Assign	Safety input #? function assignment	byte	8	R		0: Not Using 1: SF1-User Connected ESTOP Input 2: SF3-User Connected External Safeguard Input 3: SF9-User Connected External Safeguard Input 4: for Human-Machine Safety Settings 4: SF15-User Connected Enabling Switch Input* 5: SF16-User Connected ESTOP Input without Robot ESTOP Output 6: SF25-User Connected MODE Switch Input* 7: SF26-User Connected Reset Input* 8: SF27-User Connected Soft Axis Settings Switch Input 9: SF32-User Connected External Bumping Sensor Input		X (SO3, 5~7)
SI	Safety input #? status	byte	8	R		0: Low 1: High		
Ctrl_DO?	Digital Output #?	byte	1	R/W	M/A	High:1 Low:0		
Ctrl_DI?	Digital Output #?	byte	1	R		High:1 Low:0		
Ctrl_AO?	Analog Output #?	byte	1	R/W	M/A	Unit: Voltage		
Ctrl_AI?	Analog Output #?	byte	1	R		Unit: Voltage		
End_DO?	Digital Output #?	byte	1	R/W	M/A	High:1 Low:0		
End_DI?	Digital Output #?	byte	1	R		High:1 Low:0		
End_AO?	Analog Output #?	byte	1	R/W	M/A	Unit: Voltage		
End_AI?	Analog Output #?	byte	1	R		Unit: Voltage		
Ext?_DO	External Module #? Digital Output	byte	128	R/W	M/A	High:1 Low:0		
Ext?_DO_Mask	External Module #? Digital Output Mask	byte	128	R/W	M/A	High:Set Value Low:Ignore		
Ext?_DI	External Module #? Digital input	byte	128	R		High:1 Low:0		
Ext?_AO	External Module #? Analog Output	byte	128	R/W	M/A	Unit: Voltage		
Ext?_AO_Mask	External Module #? Analog Output Mask	byte	128	R/W	M/A	High: Set Value Low:Ignore		
Ext?_AI	External Module #? Analog input	byte	128	R		Unit: Voltage		

\*Accessibility

\*\*Writable Mode

## Appendix E: Ethernet/IP Table

### Robot to Master Device

#### TM\_1\_T2O\_RobotInfo (16 bytes)

Item Name	Starting Byte	Size	Data Type	Note	S Series	HW 3.2
ControlBoxID	0	16 bytes	string			

#### TM\_2\_T2O\_SystemAndError (48 bytes)

Item Name	Starting Byte	Size	Data Type	Note	S Series	HW 3.2
System_Temperature	16	4 bytes	float	Unit: Celsius		
System_Voltage	20	4 bytes	float	Unit: Voltage		
System_Current	24	4 bytes	float	Unit: Ampere		
Control_Current	28	4 bytes	float	Unit: mA		
End_Current	32	4 bytes	float	Unit: mA		
Error_Code	36	4 bytes	byte[4]			
Error_Time_Year	40	4 bytes	uint	Format: [YYYY]		
Error_Time_Month	44	1 byte	byte	Format: [MM]		
Error_Time_Day	45	1 byte	byte	Format: [DD]		
Error_Time_Hour	46	1 byte	byte	Format: [hh]		
Error_Time_Minute	47	1 byte	byte	Format:[mm]		
Error_Time_Second	48	1 byte	byte	Format:[ss]		
T2O_SystemAndError_Reserved1	49	3 bytes	Reserved			
Current_Time_Year	52	4 bytes	uint	Format: [YYYY]		
Current_Time_Month	56	1 byte	byte	Format: [MM]		
Current_Time_Day	57	1 byte	byte	Format: [DD]		
Current_Time_Hour	58	1 byte	byte	Format: [hh]		
Current_Time_Minute	59	1 byte	byte	Format:[mm]		
Current_Time_Second	60	1 byte	byte	Format:[ss]		
RobotLink	61	1 byte	byte	Yes:1 No: 0		
T2O_SystemAndError_Reserved2	62	2 bytes	Reserved			

#### TM\_3\_T2O\_RunSetting (32 bytes)

Item Name	Starting Byte	Size	Data Type	Note	S Series	HW 3.2
T2O_AutoRun_ProjectName	64	20 bytes	string			

Project_Status	84	1 byte	byte	bit0: isError bit1: isPlay bit2: isEdit bit3: isPause bit4: isPermission bit5: SafetyIO(GuardA) bit6: E-Stop bit7: RunSetting_Reserved		
RobotLight	85	1 byte	byte	0: Light off, when robot power off or STO state. 1: Solid Red, fatal error. 2: Flashing Red, Robot is initializing. 3: Solid Blue, standby in Auto Mode.(HW3.2) 4: Flashing Blue, in Auto Mode.(HW3.2) 5: Solid Green, standby in Manual Mode. 6: Flashing Green, in Manual Mode. 9: Alternating Blue&Red, Auto Mode error. (HW3.2) 10: Alternating Green&Red, Manual Mode error. 13: Alternating Green&Purple, in Manual Mode (Safeguard Port B trigger). 14 Alternating Blue&Purple, in Auto Mode (Safeguard Port B trigger).(HW3.2) 17. Alternating Green&White, in Manual Mode & Maintenance mode. (HW3.2) 18: Alternating White&Blue, in Auto Mode & Maintenance mode. 19: Flashing light blue, representing that it enters the Safe Startup Mode. 20: Solid White, standby in Auto Mode.(S Series) 21: Flashing White, in Auto Mode. (S Series) 22: Alternating White&Red, Auto Mode error. (S Series) 23: Alternating White&Purple, in Auto Mode (Safeguard Port B trigger).(S Series) 24: Alternating White&Yellow, in Auto Mode & Recovery mode. 25: Alternating Green&Yellow, in Manual Mode & Recovery mode. 26: Alternating Green&Blue, in Manual Mode & Maintenance mode. (S Series)		
StickSpeed	86	1 byte	byte	Unit: %		

				Project speed can only be written multiples of five ( $5 \leq \text{Project Speed} \leq 100$ ) *Refer to safety manual for detail		
T20_StickStatus	87	1 byte	byte	bit0: PlayPause bit1: Stop bit2: Plus bit3: Minus bit4: Play bit5: Pause		X (bit4, 5)
ManualAuto	88	1 byte	byte	M:1; A:2		
T20_CameraLight	89	1 byte	byte	Enable: 1 Disable: 0		
RobotState	90	1 bytes	byte	0: Normal 1: SOS 2: Error 3: Recovery Mode 4: STO (Including ESTOP)		
T20_RunSetting_Reserved	91	5 bytes	Reserved			

#### TM\_4\_T20\_TCP

(68 bytes)

Item Name	Starting Byte	Size	Data Type	Note	S Series	HW 3.2
Current_TCP_Value	96	24 bytes	float[6]	Unit: mm		
Current_TCP_Mass	120	4 bytes	float	Unit: kg		
Current_TCP_MOI	124	12 bytes	float[3]	Unit: mm-kg		
Current_TCP_MCF	136	24 bytes	float[6]	Unit: mm		
T20_TCP_Reserved	160	4 bytes	Reserved			

#### TM\_5\_T20\_Coordinate

(72 bytes)

Item Name	Starting Byte	Size	Data Type	Note	S Series	HW 3.2
Current_Base_Value	164	24 bytes	float[6]	Unit: mm, deg		
Coord_Joint	188	24 bytes	float[6]	Unit: degree		
Coord_CurrBase_Tool	212	24 bytes	float[6]	Unit: mm, deg		

#### TM\_6\_T20\_TCPForce

(40 bytes)

Item Name	Starting Byte	Size	Data Type	Note	S Series	HW 3.2
TCP_Force	236	12 bytes	float[3]	Unit: N		
TCP_Speed3D	248	4 bytes	float	Unit: mm/s		
Joint_Torque	252	24 bytes	float[6]	Unit: mNm		

**TM\_7\_T2O\_IO**

(24 bytes)

Item Name	Starting Byte	Size	Data Type	Note	S Series	HW 3.2
T2O_CtrlBox_DI	276	2 bytes	byte[2]	High: 1 Low: 0 ***		
T2O_CtrlBox_DO	278	2 bytes	byte[2]	High: 1 Low: 0 ***		
T2O_CtrlBox_AI	280	8 bytes	float[2]	Unit: Voltage		
T2O_CtrlBox_AO	288	4 bytes	float	Unit: Voltage		
T2O_EndModule_DI	292	1 byte	byte	High: 1 Low: 0 ***		
T2O_EndModule_DO	293	1 byte	byte	High: 1 Low: 0 ***		
T2O_IO_Reserved	294	2 bytes	Reserved			
T2O_EndModule_AI	296	4 bytes	float	Unit: Voltage		

**TM\_8\_T2O\_RegisterBit**

(8 bytes)

Item Name	Starting Byte	Size	Data Type	Note	S Series	HW 3.2
T2O_Register_Bit	300	8 bytes	bool[64]**			

**TM\_9\_T2O\_RegisterInt**

(60 bytes)

Item Name	Starting Byte	Size	Data Type	Note	S Series	HW 3.2
T2O_Register_Int	308	60 bytes	int32[15]			

**TM\_10\_T2O\_RegisterFloat**

(60 bytes)

Item Name	Starting Byte	Size	Data Type	Note	S Series	HW 3.2
T2O_Register_Float	368	60 bytes	float[15]			

**TM\_11\_T2O\_SystemReserved**

(64 bytes)

Item Name	Starting Byte	Size	Data Type	Note	S Series	HW 3.2
T2O_CtrlBox_AO_2	428	4 bytes	float	Unit: Voltage		X
T2O_SystemReserved	432	60 bytes	byte[60]			

End 492

## Master Device to Robot

### TM\_1\_O2T\_RunSetting

(88 bytes)

Item Name	Starting Byte	Size	Data Type	Note	S Series	HW 3.2
O2T_StickStatus	0	1 byte	byte	bit0: PlayPause (Toggle) bit1: Stop bit2: Plus bit3: Minus bit4: Play bit5: Pause *Refer to safety manual for detail.		
O2T_CameraLightMask	1	1 byte	byte	Set: 1, Ignore: 0		
O2T_CameraLight	2	1 byte	byte	Enable: 1 Disable: 0		
O2T_AutoRun_ProjectName_Mask	3	1 byte	byte	Set: 1, Ignore: 0 *Remote Control only		
O2T_AutoRun_ProjectName	4	20 bytes	string	*Remote Control only		
O2T_RunSetting_Reserved	24	64 bytes	Reserved			

### TM\_2\_O2T\_IO

(16 bytes)

Item Name	Starting Byte	Size	Data Type	Note	S Series	HW 3.2
O2T_CtrlBox_DO_Mask	88	2 bytes	byte[2]	Set: 1, Ignore: 0 ***		
O2T_CtrlBox_DO	90	2 bytes	byte[2]	High: 1 Low: 0 ***		
O2T_EndModule_DO_Mask	92	1 byte	byte	Set: 1, Ignore: 0 ***		
O2T_EndModule_DO	93	1 byte	byte	High: 1 Low: 0 ***		
O2T_CtrlBox_AO_Mask	94	1 byte	byte	Set: 1, Ignore: 0***		
O2T_IO_Reserved1	95	1 byte	byte			
O2T_CtrlBox_AO	96	4 bytes	float	Unit: Voltage		
O2T_CtrlBox_AO_2	100	4 bytes	float	Unit: Voltage		X

### TM\_3\_O2T\_RegisterBit

(8 bytes)

Item Name	Starting Byte	Size	Data Type	Note	S Series	HW 3.2
O2T_Register_Bit	104	8 bytes	bool[64]**			

### TM\_4\_O2T\_RegisterInt

(60 bytes)



Item Name	Starting Byte	Size	Data Type	Note	S Series	HW 3.2
O2T_Register_Int	112	60 bytes	int[15]			

---

**TM\_5\_O2T\_RegisterFloat** (60 bytes)

---

Item Name	Starting Byte	Size	Data Type	Note	S Series	HW 3.2
O2T_Register_Float	172	60 bytes	float[15]			

---

**TM\_6\_O2T\_SystemReserved** (64 bytes)

---

Item Name	Starting Byte	Size	Data Type	Note	S Series	HW 3.2
O2T_SystemReserved	232	64 bytes	byte[64]			

End 296

\*\* In TMflow, bool array data will be processed as byte array with the same array item number. Refer to Expression Editor manual for detail.

\*\*\* Independently set one channel with one bit.

Appendix F: PROFINET Data Table

**Robot to Master Device**

**TM\_1\_T2O\_RobotInfo** (48 bytes)

Item Name	Starting Byte	Size	Data Type	Note	S Series	HW 3.2
ControlBoxID	0	16 bytes	string			
RobotModel	16	16 bytes	string			
HMIVersion	32	16 bytes	string			

**TM\_2\_T2O\_SystemAndError** (64bytes)

Item Name	Starting Byte	Size	Data Type	Note	S Series	HW 3.2
Error_Code	48	4 bytes	byte[4]			
Error_Time_YY	52	4 bytes	int32	Format: [YYYY]		
Error_Time_MM	56	1 byte	byte	Format: [MM]		
Error_Time_DD	57	1 byte	byte	Format: [DD]		
Error_Time_hh	58	1 byte	byte	Format: [hh]		
Error_Time_mm	59	1 byte	byte	Format:[mm]		
Error_Time_ss	60	1 byte	byte	Format:[ss]		
RobotLink	61	1 byte	byte	Yes:1 No: 0		
System_Temperature	62	4 bytes	float	Unit: Celsius		
System_Voltage	66	4 bytes	float	Unit: Voltage		
System_Consumption	70	4 bytes	float	Unit: Watt		
System_Current	74	4 bytes	float	Unit: Ampere		
Control_Current	78	4 bytes	float	Unit: mA		
End_Current	82	4 bytes	float	Unit: mA		
Current_Time_YY	86	4 bytes	int32	Format: [YYYY]		
Current_Time_MM	90	1 byte	byte	Format: [MM]		
Current_Time_DD	91	1 byte	byte	Format: [DD]		
Current_Time_hh	92	1 byte	byte	Format: [hh]		
Current_Time_mm	93	1 byte	byte	Format:[mm]		
Current_Time_ss	94	1 byte	byte	Format:[ss]		
SystemAndError_Reserved2	95	1 byte	Reserved			
SystemAndError_Reserved	96	16 bytes	Reserved			

**TM\_3\_T2O\_RunSetting** (80 bytes)

Item Name	Starting Byte	Size	Data Type	Note	S Series	HW 3.2
AutoRun_ProjectName	112	64 bytes	string			

Project_Status	176	1 byte	byte	bit0: isError bit1: isPlay bit2: isEdit bit3: isPause bit4: isPermission bit5: SafetyIO(GuardA) bit6: E-Stop bit7: RunSetting_Reserved
RobotLight	177	1 byte	byte	0: Light off, when robot power off or STO state. 1: Solid Red, fatal error. 2: Flashing Red, Robot is initializing. 3: Solid Blue, standby in Auto Mode.(HW3.2) 4: Flashing Blue, in Auto Mode.(HW3.2) 5: Solid Green, standby in Manual Mode. 6: Flashing Green, in Manual Mode. 9: Alternating Blue&Red, Auto Mode error. (HW3.2) 10: Alternating Green&Red, Manual Mode error. 13: Alternating Green&Purple, in Manual Mode (Safeguard Port B trigger). 14 Alternating Blue&Purple, in Auto Mode (Safeguard Port B trigger).(HW3.2) 17. Alternating Green&White, in Manual Mode & Maintenance mode. (HW3.2) 18: Alternating White&Blue, in Auto Mode & Maintenance mode. 19: Flashing light blue, representing that it enters the Safe Startup Mode. 20: Solid White, standby in Auto Mode.(S Series) 21: Flashing White, in Auto Mode. (S Series) 22: Alternating White&Red, Auto Mode error. (S Series) 23: Alternating White&Purple, in Auto Mode (Safeguard Port B trigger).(S Series) 24: Alternating White&Yellow, in Auto Mode & Recovery mode.

				25: Alternating Green&Yellow, in Manual Mode & Recovery mode. 26: Alternating Green&Blue, in Manual Mode & Maintenance mode. (S Series)		
StickSpeed	178	1 byte	byte	Unit: % Project speed can only be written multiples of five ( $5 \leq \text{Project Speed} \leq 100$ ) *Refer to safety manual for detail		
StickStatus	179	1 byte	byte	bit0: PlayPause bit1: Stop bit2: Plus bit3: Minus bit4: Play bit5: Pause		X (bit4, 5)
ManualAuto	180	1 byte	byte	M:1; A:2		
CameraLight	181	1 byte	byte	Enable: 1 Disable: 0		
RobotState	182	1 byte	byte	0: Normal 1: SOS 2: Error 3: Recovery Mode 4: STO (Including ESTOP)		
RunSetting_Reserved	183	9 bytes	Reserved			

#### TM\_4\_T2O\_TCP

(68 bytes)

Item Name	Starting Byte	Size	Data Type	Note	S Series	HW 3.2
Current_TCP_Value	192	24 bytes	float[6]	Unit: mm		
Current_TCP_Mass	216	4 bytes	float	Unit: kg		
Current_TCP_MOI	220	12 bytes	float[3]	Unit: mm-kg		
Current_TCP_MCF	232	24 bytes	float[6]	Unit: mm		
TCP_Reserved	256	4 bytes	Reserved			

#### TM\_5\_T2O\_Coordinate

(168 bytes)

Item Name	Starting Byte	Size	Data Type	Note	S Series	HW 3.2
Current_Base_Value	260	24 bytes	float[6]	Unit: mm, deg		
Coord_Joint	284	24 bytes	float[6]	Unit: degree		
Coord_CurrBase_Tool	308	24 bytes	float[6]	Unit: mm, deg		
Coord_RobotBase_Tool	332	24 bytes	float[6]	Unit: mm, deg		
Coordinate_Reserved	356	72 bytes	Reserved			

**TM\_6\_T2O\_TCPForce**

(88 bytes)

Item Name	Starting Byte	Size	Data Type	Note	S Series	HW 3.2
TCP_Force	428	12 bytes	float[3]	Unit: N		
TCP_Force3D	440	4 bytes	float	Unit: N		
TCP_Speed3D	444	4 bytes	float	Unit: mm/s		
Joint_Torque	448	24 bytes	float[6]	Unit: mNm		
TCPForce_Reserved	472	44 bytes	Reserved			

**TM\_7\_T2O\_IO**

(24 bytes)

Item Name	Starting Byte	Size	Data Type	Note	S Series	HW 3.2
CtrlBox_DI	516	2 bytes	byte[2]	High: 1 Low: 0 ***		
CtrlBox_DO	518	2 bytes	byte[2]	High: 1 Low: 0 ***		
CtrlBox_AI	520	8 bytes	float[2]	Unit: Voltage		
CtrlBox_AO	528	4 bytes	float	Unit: Voltage		
EndModule_DI	532	1 byte	byte	High: 1 Low: 0 ***		
EndModule_DO	533	1 byte	byte	High: 1 Low: 0 ***		
EndModule_AI	534	4 bytes	float	Unit: Voltage		
IO_Reserved	538	2 bytes	Reserved			

**TM\_8\_T2O\_RegisterBit**

(16 bytes)

Item Name	Starting Byte	Size	Data Type	Note	S Series	HW 3.2
Register_Bit	540	16 bytes	bool[128]**			

**TM\_9\_T2O\_RegisterInt**

(120 bytes)

Item Name	Starting Byte	Size	Data Type	Note	S Series	HW 3.2
Register_Int	556	120 bytes	int32[30]			

**TM\_10\_T2O\_RegisterFloat**

(120 bytes)

Item Name	Starting Byte	Size	Data Type	Note	S Series	HW 3.2
Register_Float	676	120 bytes	float[30]			

**TM\_11\_T2O\_SystemReserved1** (64 bytes)

Item Name	Starting Byte	Size	Data Type	Note	S Series	HW 3.2
CtrlBox_AO_2	796	4 bytes	float	Unit: Voltage		X
SystemReserved1	800	60 bytes	byte[60]			

**TM\_12\_T2O\_SystemReserved2** (64 bytes)

Item Name	Starting Byte	Size	Data Type	Note	S Series	HW 3.2
SystemReserved2	860	64 bytes	byte[64]			

End 924

**Master Device to Robot**

**TM\_1\_O2T\_RunSetting** (132 bytes)

Item Name	Starting Byte	Size	Data Type	Note	S Series	HW 3.2
StickStatus	0	1 byte	byte	bit0: PlayPause (Toggle) bit1: Stop bit2: Plus bit3: Minus bit4: Play bit5: Pause *Refer to safety manual for detail.		
CameraLightMask	1	1 byte	byte	Set: 1, Ignore: 0		
CameraLight	2	1 byte	byte	Enable: 1 Disable: 0		
AutoRun_ProjectName_Mask	3	1 byte	byte	Set: 1, Ignore: 0 *Remote Control only		
AutoRun_ProjectName	4	64 bytes	string	*Remote Control only		
RunSetting_Reserved	68	64 bytes	Reserved			

**TM\_2\_O2T\_IO** (16 bytes)

Item Name	Starting Byte	Size	Data Type	Note	S Series	HW 3.2
CtrlBox_DO_Mask	132	2 bytes	byte[2]	Set: 1, Ignore: 0 ***		
CtrlBox_DO	134	2 bytes	byte[2]	High: 1 Low: 0 ***		
EndModule_DO_Mask	136	1 byte	byte	Set: 1, Ignore: 0 ***		
EndModule_DO	137	1 byte	byte	High: 1 Low: 0 ***		

CtrlBox_AO_Mask	138	1 byte	byte	Set: 1, Ignore: 0***		
IO_Reserved1	139	1 byte	byte			
CtrlBox_AO	140	4 bytes	float	Unit: Voltage		
CtrlBox_AO_2	144	4 bytes	float	Unit: Voltage		X

**TM\_3\_O2T\_RegisterBit** (16 bytes)

Item Name	Starting Byte	Size	Data Type	Note	S Series	HW 3.2
Register_Bit	148	16 bytes	bool[128]**			

**TM\_4\_O2T\_RegisterInt** (120 bytes)

Item Name	Starting Byte	Size	Data Type	Note	S Series	HW 3.2
Register_Int	164	120 bytes	int[30]			

**TM\_5\_O2T\_RegisterFloat** (120 bytes)

Item Name	Starting Byte	Size	Data Type	Note	S Series	HW 3.2
Register_Float	284	120 bytes	float[30]			

**TM\_6\_O2T\_SystemReserved1** (64 bytes)

Item Name	Starting Byte	Size	Data Type	Note	S Series	HW 3.2
SystemReserved1	404	64 bytes	byte[64]			

**TM\_7\_O2T\_SystemReserved2** (64 bytes)

Item Name	Starting Byte	Size	Data Type	Note	S Series	HW 3.2
SystemReserved2	468	64 bytes	byte[64]			

End 532

\*\* In TMflow, bool array data will be processed as byte array with the same array item number. Refer to Expression Editor manual for detail.

\*\*\* Independently set one channel with one bit.

## Appendix G: Error Descriptions and Suggestions

ErrorDescription00000000	No Alarm
ErrorDescription00000001	Inverse Kinematics Failure, Working Range Issue
ErrorDescription00000005	Stop Motion Command
ErrorDescription00000008	Robot Controller Function Library Issue - Inverse Kinematics
ErrorDescription00000009	Robot Controller Function Library Issue
ErrorDescription0000000A	Cartesian Space Move Failure From Robot Base Space
ErrorDescription0000000B	Trajectory Coordination System Calculation Failure
ErrorDescription00000010	Tool Connected Failure With Robot
ErrorDescription00000011	Inverse Kinematics Failure, Motion Blending Issue
ErrorDescription00000012	Inverse Kinematics Failure, Interpolation Points Issue
ErrorDescription00000013	PTP function Failure in Driver
ErrorDescription00000014	Over Range Between the Interpolation Points
ErrorDescription00000015	Create Circle Path Failed
ErrorDescription00000016	Motion Failure due to Max Points Counts Issue in the NURBS
ErrorDescription00000017	Forward Kinematics Failure, Interpolation Points Issue
ErrorDescription00000018	Inverse Jacobian Matrices Failure jacobian
ErrorDescription00000019	Timeout in Steady State Error in Motion Process.
ErrorDescription0000001A	Motion Failure when Moving at Constant Speed
ErrorDescription0000001B	Target of Line Motion is Out of reachable point of Robot
ErrorDescription0000001C	Target of PtP Motion is Out of Joint Boundary
ErrorDescription00000021	Velocity or Angular Velocity Over Range
ErrorDescription00000022	Force or Torque Over Range
ErrorDescription00000023	Both Alarm in Error(HEX)21 and Error(HEX)22
ErrorDescription00000024	Shock Alarm in the Robot
ErrorDescription00000028	Driver mode switching timeout.
ErrorDescription0000002D	Joint Signature mismatch with vendor
ErrorDescription0000002E	gear ratio is not match the model
ErrorDescription0000002F	Pose error by g-sensor g sensor
ErrorDescription00000030	Over Current in the Power Supply 24V, I/O Board Alarm
ErrorDescription00000031	Safety function initialized failure
ErrorDescription00000032	Disconnect with safety monitor module
ErrorDescription00000033	TCP Speed over the criterion on the manual mode
ErrorDescription00000034	Joint Drivers Servo on is timeout
ErrorDescription00000035	Joint Drivers Alarm
ErrorDescription00000036	Absolution Position Calibration Failure in the Joint Drivers.
ErrorDescription00000037	Clear Robot Alarm Failure
ErrorDescription00000038	Failed to turn Servo On in Joint Driver
ErrorDescription00000039	Failed to turn into Safe OP Mode in the EtherCAT Loop.
ErrorDescription0000003A	Failed to turn into OP Mode in the EtherCAT Loop.
ErrorDescription0000003B	The Joint Numbers of the Robot does not match the Default Setting
ErrorDescription0000003C	This Model is not supported
ErrorDescription0000003D	Emergency Button Pressed before the Robot Initialization finished.
ErrorDescription0000003E	the 48V power NG on the ESM-PreOP mode
ErrorDescription00000040	Joint ESI does not match the Default Setting
ErrorDescription00000041	Failed to execute SDO command
ErrorDescription00000042	Failed to read Manufacturer ID



ErrorDescription00000043	Failed to initialize EtherCAT
ErrorDescription00000044	Failed to turn into DC SYNC in the EtherCAT Loop
ErrorDescription00000045	EtherCAT Slaves in the boot mode is waiting for flash the firmware.
ErrorDescription00000048	the 48V power NG on the ESM-OP mode
ErrorDescription00000049	Power supply 48V failure
ErrorDescription0000004A	Timeout in the EtherCAT Loop
ErrorDescription0000004B	The Slave Numbers does not Match the Default Numbers
ErrorDescription0000004C	Failed to Access EEPROM Data in the Power Board
ErrorDescription0000004D	Failed to Access Live Data
ErrorDescription0000004E	The S/N of the Joints does not match the default setting
ErrorDescription0000004F	Power Board is Missing
ErrorDescription00000050	Power Board Lost Connection
ErrorDescription00000051	Power Board Overheat
ErrorDescription00000052	Robot performed Cat.1 stop.
ErrorDescription00000053	The Current or Voltage in the 48V Power Supply is out of range
ErrorDescription00000054	The Current is still out of range under current limit constrain
ErrorDescription00000055	The Current is out of range in the 24V Power Supply
ErrorDescription00000056	I/O Board Lost Connection
ErrorDescription00000057	Joints Lost Connection
ErrorDescription00000058	HMI Lost Connection with Robot Controller
ErrorDescription00000059	System Reset
ErrorDescription0000005A	System Shutdown
ErrorDescription0000005B	Motion Stopped by Robot Stick key
ErrorDescription0000005C	Buzzer Failure in the Robot Stick Key
ErrorDescription0000005D	EtherCAT Lost Connection
ErrorDescription0000005E	An alarm occurs in the Safety Monitor Board
ErrorDescription0000005F	An alarm is triggered by Input Pin in the Safety Monitor Board
ErrorDescription00000060	The Motion Command Executed under Manual Mode at the same time
ErrorDescription00000061	The Motion Command Executed with Compliance Mode at the same time
ErrorDescription00000062	The Pose of the Robot is closer to the singularity in the manual mode
ErrorDescription00000063	The Pose of the Robot is closer to the singularity in the Compliance Mode
ErrorDescription00000066	Power Eater Temperature Alarm
ErrorDescription0000006A	It is a test command to disconnect with safety monitor board
ErrorDescription0000006E	[Error][Safety Function]Encoder Standstill function activated
ErrorDescription0000006F	3D Viewer Lost Connection
ErrorDescription00000070	Vision Servoing Failure
ErrorDescription00000071	Stop the Vision Servoing Process
ErrorDescription00000072	The Pose of the Robot Over the Position or Close to the Singularity during Vision Servoing Process
ErrorDescription00000073	Alarms occurred in Data Flow in Vision Servoing
ErrorDescription00000074	Operation Mode Switching Failure occurred in the Joint Drivers during Vision Servoing
ErrorDescription00000075	Vision Servoing failed to get image
ErrorDescription00000076	There is an alarm in Blending Process in the Vision Servoing Block
ErrorDescription00000080	TmSync : Group Members Over Specification
ErrorDescription00000081	TmSync : Group Members Alarm
ErrorDescription00000082	TmSync : Group Members Lost Connection
ErrorDescription00000083	TmSync : Robot Lost connection
ErrorDescription00000084	TmSync : Robot ID Conflict In The Group

ErrorDescription00000085	TmSync : MacID Conflict In The Group
ErrorDescription00000086	TmSync : Enable networking with specified NIC Failure
ErrorDescription00000090	Process Line Motion Failure
ErrorDescription000000A0	[Error][Safety Function]Violate Encoder Standstill when no motion is allowed.
ErrorDescription000000A1	[Error][Safety Function]Violate Encoder Standstill when error occurred.
ErrorDescription000000A2	[Error][Safety Function]Violate Encoder Standstill when Safeguard Port a triggered
ErrorDescription000000A3	[Error][Safety Function]Violate Encoder Standstill when no motion is allowed.
ErrorDescription000000A4	[Error][Safety Function]Violate Encoder Standstill in stop area
ErrorDescription000000A5	[Error][Safety Function]Violate Encoder Standstill in Cat.2 stop status.
ErrorDescription000000A6	[Error][Safety Function] Discrepancy was detected between dual channels Internal Protective Output.
ErrorDescription000000A7	[Error][Safety Function] Discrepancy was detected between dual channels Encoder Standstill Output.
ErrorDescription000000A8	[Warning][External Device] Discrepancy was detected between dual channels of Emergency Stop Port.
ErrorDescription000000A9	[Warning][External Device] Discrepancy was detected between dual channels of Safeguard Port a.
ErrorDescription000000AA	[Warning][External Device] Discrepancy was detected between dual channels of Safeguard Port B.
ErrorDescription000000AB	[Warning][External Device] Discrepancy was detected between dual channels of Enabling Device Ports.
ErrorDescription000000AD	[Error][Safety Function] Discrepancy was detected between dual channels of Emergency Stop Output.
ErrorDescription000000AE	[Error][Safety Function] Discrepancy was detected between dual channels of Safeguard Port a Output.
ErrorDescription000000AF	[Error][Safety Function] Discrepancy was detected between dual channels of Safeguard Port B Output.
ErrorDescription000000B0	HMI Serial Port COM Lost Connection with Robot Controller
ErrorDescription000000C0	[Error][Safety] Robot performed Cat.0 Stop
ErrorDescription000000C1	[Error][Safety] Robot performed Cat.1 Stop
ErrorDescription000000C2	[Error][Safety] Robot performed Cat.2 Stop
ErrorDescription000000C3	Robot motion STOP by Robot Stick status changed
ErrorDescription000000C4	Robot motion STOP by Operation Mode changed
ErrorDescription000000C5	Robot motion STOP by Configuration Tool login
ErrorDescription000000CB	[Error][Safety] Safety Module Settings Error
ErrorDescription000000CC	[Error][Safety] Safety Module Communication Fault
ErrorDescription000000CD	[Error][Safety] Safety inputs discrepancy detected
ErrorDescription000000CE	[Error][Safety] Safety Module Systematic Fault
ErrorDescription000000CF	[Error][Safety] Safety Module Communication Fault
ErrorDescription000000F0	HIM Command to shut down the robot system
ErrorDescription00004500	EtherCAT Slave 0 in the boot mode is waiting for flash the firmware.
ErrorDescription00004501	EtherCAT Slave 1 in the boot mode is waiting for flash the firmware.
ErrorDescription00004502	EtherCAT Slave 2 in the boot mode is waiting for flash the firmware.
ErrorDescription00004503	EtherCAT Slave 3 in the boot mode is waiting for flash the firmware.
ErrorDescription00004504	EtherCAT Slave 4 in the boot mode is waiting for flash the firmware.
ErrorDescription00004505	EtherCAT Slave 5 in the boot mode is waiting for flash the firmware.
ErrorDescription00004506	EtherCAT Slave 6 in the boot mode is waiting for flash the firmware.
ErrorDescription00004507	EtherCAT Slave 7 in the boot mode is waiting for flash the firmware.
ErrorDescription00004508	EtherCAT Slave 8 in the boot mode is waiting for flash the firmware.
ErrorDescription0000C211	[Error][Safety Function] J1 position exceeds limit
ErrorDescription0000C212	[Error][Safety Function] J2 position exceeds limit
ErrorDescription0000C213	[Error][Safety Function] J3 position exceeds limit
ErrorDescription0000C214	[Error][Safety Function] J4 position exceeds limit
ErrorDescription0000C215	[Error][Safety Function] J5 position exceeds limit
ErrorDescription0000C216	[Error][Safety Function] J6 position exceeds limit
ErrorDescription0000C221	[Error][Safety Function] J1 speed exceeds limit

ErrorDescription0000C222	[Error][Safety Function] J2 speed exceeds limit
ErrorDescription0000C223	[Error][Safety Function] J3 speed exceeds limit
ErrorDescription0000C224	[Error][Safety Function] J4 speed exceeds limit
ErrorDescription0000C225	[Error][Safety Function] J5 speed exceeds limit
ErrorDescription0000C226	[Error][Safety Function] J6 speed exceeds limit
ErrorDescription0000C231	[Error][Safety Function] Safety tool point 1 position exceeds Cartesian limit
ErrorDescription0000C232	[Error][Safety Function] Safety tool point2 position exceeds Cartesian limit
ErrorDescription0000C233	[Error][Safety Function] Safety tool point 3 position exceeds Cartesian limit
ErrorDescription0000C234	[Error][Safety Function] Safety tool point 4 position exceeds Cartesian limit
ErrorDescription0000C235	[Error][Safety Function] Safety tool point 5 position exceeds Cartesian limit
ErrorDescription0000C236	[Error][Safety Function] Safety tool point6 position exceeds Cartesian limit
ErrorDescription0000C237	[Error][Safety Function] Safety tool point 7 position exceeds Cartesian limit
ErrorDescription0000C238	[Error][Safety Function] Safety tool point8 position exceeds Cartesian limit
ErrorDescription0000C239	[Error][Safety Function] Basic safety tool point position exceeds Cartesian limit
ErrorDescription0000C23A	[Error][Safety Function] Elbow position exceeds Cartesian limit
ErrorDescription0000C241	[Error][Safety Function] Safety tool point 1 speed exceeds limit
ErrorDescription0000C242	[Error][Safety Function] Safety tool point2 speed exceeds limit
ErrorDescription0000C243	[Error][Safety Function] Safety tool point 3 speed exceeds limit
ErrorDescription0000C244	[Error][Safety Function] Safety tool point 4 speed exceeds limit
ErrorDescription0000C245	[Error][Safety Function] Safety tool point 5 speed exceeds limit
ErrorDescription0000C246	[Error][Safety Function] Safety tool point6 speed exceeds limit
ErrorDescription0000C247	[Error][Safety Function] Safety tool point 7 speed exceeds limit
ErrorDescription0000C248	[Error][Safety Function] Safety tool point8 speed exceeds limit
ErrorDescription0000C249	[Error][Safety Function] Basic safety tool point speed exceeds limit
ErrorDescription0000C24A	[Error][Safety Function] Elbow speed exceeds limit
ErrorDescription0000C251	[Error][Safety Function] Safety tool point 1 speed exceeds reduced speed limit
ErrorDescription0000C252	[Error][Safety Function] Safety tool point2 speed exceeds reduced speed limit
ErrorDescription0000C253	[Error][Safety Function] Safety tool point 3 speed exceeds reduced speed limit
ErrorDescription0000C254	[Error][Safety Function] Safety tool point 4 speed exceeds reduced speed limit
ErrorDescription0000C255	[Error][Safety Function] Safety tool point 5 speed exceeds reduced speed limit
ErrorDescription0000C256	[Error][Safety Function] Safety tool point6 speed exceeds reduced speed limit
ErrorDescription0000C257	[Error][Safety Function] Safety tool point 7 speed exceeds reduced speed limit
ErrorDescription0000C258	[Error][Safety Function] Safety tool point8 speed exceeds reduced speed limit
ErrorDescription0000C259	[Error][Safety Function] Basic safety tool point speed exceeds reduced speed limit
ErrorDescription0000C25A	[Error][Safety Function] Robot end-point 1 speed exceeds reduced speed limit
ErrorDescription0000C25B	[Error][Safety Function] Robot end-point2 speed exceeds reduced speed limit
ErrorDescription0000C25C	[Error][Safety Function] Robot end-point 3 speed exceeds reduced speed limit
ErrorDescription0000C25D	[Error][Safety Function] Robot end-point 4 speed exceeds reduced speed limit
ErrorDescription0000C25E	[Error][Safety Function] Robot end-point 5 speed exceeds reduced speed limit
ErrorDescription0000C25F	[Error][Safety Function] Robot end-point6 speed exceeds reduced speed limit
ErrorDescription0000C261	[Error][Safety Function] J1 torque exceeds limit
ErrorDescription0000C262	[Error][Safety Function] J2 torque exceeds limit
ErrorDescription0000C263	[Error][Safety Function] J3 torque exceeds limit
ErrorDescription0000C264	[Error][Safety Function] J4 torque exceeds limit
ErrorDescription0000C265	[Error][Safety Function] J5 torque exceeds limit
ErrorDescription0000C266	[Error][Safety Function] J6 torque exceeds limit
ErrorDescription0000C271	[Error][Safety Function] TCP force exceeds limit

ErrorDescription0000C272	[Error][Safety Function] Elbow force exceeds limit
ErrorDescription0000C273	[Error][Safety Function] TCP and elbow force exceeds limit
ErrorDescription0000C280	[Error][Safety Function] Bumping sensor input triggered
ErrorDescription0000CD00	[Error][Safety] Safety inputs discrepancy detected in ES ports
ErrorDescription0000CD01	[Error][Safety] Safety inputs discrepancy detected in SFG ports
ErrorDescription0000CD02	[Error][Safety] Safety inputs discrepancy detected in SI2 ports
ErrorDescription0000CD03	[Error][Safety] Safety inputs discrepancy detected in SI3 ports
ErrorDescription0000CD04	[Error][Safety] Safety inputs discrepancy detected in SI4 ports
ErrorDescription0000CD05	[Error][Safety] Safety inputs discrepancy detected in SI5 ports
ErrorDescription0000CD06	[Error][Safety] Safety inputs discrepancy detected in SI6 ports
ErrorDescription0000CD07	[Error][Safety] Safety inputs discrepancy detected in SI7 ports
ErrorDescription0000CD08	[Error][Safety] Safety outputs discrepancy detected in SO0 ports
ErrorDescription0000CD09	[Error][Safety] Safety outputs discrepancy detected in SO1 ports
ErrorDescription0000CD0A	[Error][Safety] Safety outputs discrepancy detected in SO2 ports
ErrorDescription0000CD0B	[Error][Safety] Safety outputs discrepancy detected in SO3 ports
ErrorDescription0000CD0C	[Error][Safety] Safety outputs discrepancy detected in SO4 ports
ErrorDescription0000CD0D	[Error][Safety] Safety outputs discrepancy detected in SO5 ports
ErrorDescription0000CD0E	[Error][Safety] Safety outputs discrepancy detected in SO6 ports
ErrorDescription0000CD0F	[Error][Safety] Safety outputs discrepancy detected in SO7 ports
ErrorDescription0000CD10	[Error][Safety] Safety inputs discrepancy detected on Robot Stick Emergency Stop Button
ErrorDescription0000CD11	[Error][Safety] Safety inputs discrepancy detected on Robot Stick Enabling Switch
ErrorDescription0000CD12	[Error][Safety] Safety inputs discrepancy detected on Robot Stick Reset Button
ErrorDescription00008000	[Warning][External Device] Discrepancy was detected between dual channels of Robot Stick ESTOP Port.
ErrorDescription00008001	[Warning][External Device] Discrepancy was detected between dual channels of User Connected ESTOP Input Port.
ErrorDescription00008002	[Warning][External Device] Discrepancy was detected between dual channels of User Connected External Safeguard Input Port.
ErrorDescription00008003	[Warning][External Device] Discrepancy was detected between dual channels of User Connected External Safeguard Input Port for Human – Machine Safety Settings.
ErrorDescription00008004	[Warning][External Device] Discrepancy was detected between dual channels of User Connected Enabling Device Input Port.
ErrorDescription00008005	[Warning][External Device] Discrepancy was detected between dual channels of User Connected ESTOP Input Port without Robot ESTOP Output.
ErrorDescription00008006	[Warning][External Device] Discrepancy was detected between dual channels of Safeguard Port.
ErrorDescription00008007	[Warning][External Device] Discrepancy was detected between dual channels of Safeguard Port.
ErrorDescription00008008	[Error][Safety Function] Discrepancy was detected between dual channels of Robot ESTOP Output Port.
ErrorDescription00008009	[Error][Safety Function] Discrepancy was detected between dual channels of User Connected External Safeguard Output Port.
ErrorDescription0000800A	[Error][Safety Function] Discrepancy was detected between dual channels of User Connected External Safeguard Output Port for Human – Machine Safety Settings.
ErrorDescription0000800B	[Error][Safety Function] Discrepancy was detected between dual channels of Robot Internal Protective Stop Output Port.
ErrorDescription0000800C	[Error][Safety Function] Discrepancy was detected between dual channels of Robot Encoder Standstill Output Port.
ErrorDescription0000FF00	Self-Collision
ErrorDescription0000FF01	[Error][Safety Function]Momentum exceeds limit
ErrorDescription0000FF02	[Error][Safety Function]Power exceeds limit
ErrorDescription0000FF03	Collaboration Area
ErrorDescription0000FF04	[Error][Safety Function]TCP speed exceeds limit

ErrorDescription0000FF05	[Error][Safety Function]TCP force exceeds limit
ErrorDescription0000FF06	[Error][Safety Function]J1 Position exceeds limit
ErrorDescription0000FF07	[Error][Safety Function]J1 Velocity exceeds limit
ErrorDescription0000FF08	[Error][Safety Function]J1 Torque exceeds limit
ErrorDescription0000FF09	[Error][Safety Function]J2 Position exceeds limit
ErrorDescription0000FF0A	[Error][Safety Function]J2 Velocity exceeds limit
ErrorDescription0000FF0B	[Error][Safety Function]J2 Torque exceeds limit
ErrorDescription0000FF0C	[Error][Safety Function]J3 Position exceeds limit
ErrorDescription0000FF0D	[Error][Safety Function]J3 Velocity exceeds limit
ErrorDescription0000FF0E	[Error][Safety Function]J3 Torque exceeds limit
ErrorDescription0000FF0F	[Error][Safety Function]J4 Position exceeds limit
ErrorDescription0000FF10	[Error][Safety Function]J4 Velocity exceeds limit
ErrorDescription0000FF11	[Error][Safety Function]J4 Torque exceeds limit
ErrorDescription0000FF12	[Error][Safety Function]J5 Position exceeds limit
ErrorDescription0000FF13	[Error][Safety Function]J5 Velocity exceeds limit
ErrorDescription0000FF14	[Error][Safety Function]J5 Torque exceeds limit
ErrorDescription0000FF15	[Error][Safety Function]J6 Position exceeds limit
ErrorDescription0000FF16	[Error][Safety Function]J6 Velocity exceeds limit
ErrorDescription0000FF17	[Error][Safety Function]J6 Torque exceeds limit
ErrorDescription0000FF18	J7 Position exceeds limit
ErrorDescription0000FF19	J7 Velocity exceeds limit
ErrorDescription0000FF1A	J7 Torque exceeds limit
ErrorDescription00013880	Illegal dimension of a matrix or vector
ErrorDescription00013881	At least one element of a matrix or vector is with illegal index
ErrorDescription00013882	Illegal rotation matrix
ErrorDescription00013883	Illegal homogeneous transformation
ErrorDescription00013884	Illegal skew matrix
ErrorDescription00013885	Illegal square matrix
ErrorDescription00013886	Matrix inverse failed
ErrorDescription00013887	Illegal norm value
ErrorDescription00013888	Householder transformation failed
ErrorDescription00013889	Eigenvalue calculation failed
ErrorDescription0001388A	Illegal number of Eigenvalues
ErrorDescription0001388B	Matrix is singular
ErrorDescription0001388C	Illegal upper/lower triangular matrix
ErrorDescription0001388D	Elementary matrix operation failed
ErrorDescription0001388E	Gaussian Elimination failed
ErrorDescription0001388F	Null space does not exist
ErrorDescription00013890	QR decomposition failed
ErrorDescription00013891	QR iteration diverged
ErrorDescription00013892	Circle path center calculation failed
ErrorDescription00013893	Circle path planning initialization failed
ErrorDescription00013894	Kalman gain calculation failed
ErrorDescription00013895	Kalman filter initialization need to be done
ErrorDescription00013896	Illegal index to get/set a component of a matrix/vector
ErrorDescription00013897	Illegal size/format of function input variables
ErrorDescription00013898	Illegal size/format of function returned variables



ErrorDescription00013899	Solve $a \sin(x) + B \cos(x) = C$ failed
ErrorDescription0001389A	Solve $AX = XB$ failed
ErrorDescription0001389B	Effective data is not enough
ErrorDescription0001389C	Specific axis are parallel
ErrorDescription0001389D	Solve $a = XBY$ failed
ErrorDescription0001389E	No initial guessing matrix
ErrorDescription0001389F	Transform type mismatch
ErrorDescription000138A0	Illegal dimension of a quaternion
ErrorDescription000138A1	Illegal string format of a quaternion
ErrorDescription000138A2	Quaternion setting failed
ErrorDescription000138A3	Quaternion transfer to angle-axis failed
ErrorDescription000138A4	Failed to get rotation vector via quaternion
ErrorDescription000138A5	Failed to solve sub-block Eigenvalue
ErrorDescription00013C68	End effector data file does not yet been loaded
ErrorDescription00013C69	The end effector has existed already
ErrorDescription00013C6A	At least one end effector should be selected for your task
ErrorDescription00013C6B	Illegal end effector data format
ErrorDescription00013C6C	Illegal end effector serial number
ErrorDescription00013C6D	This end effector is not on our list
ErrorDescription00013C6E	End effector should be connected
ErrorDescription00013C6F	End effector should be disconnected
ErrorDescription00013C70	Setting end effector parameters to robot object failed
ErrorDescription00013C71	End effector parameters acquisition from end effector object failed
ErrorDescription00013C72	End effector connection with robot failed
ErrorDescription00013C73	End effector has connected with robot
ErrorDescription00013C74	End effector reconnection with robot failed
ErrorDescription00013C75	End effector data lost
ErrorDescription00014050	Illegal DOF of robot
ErrorDescription00014051	The total number of robot parameters is illegal
ErrorDescription00014052	Illegal DOF of generalized Cartesian position, velocity, or acceleration
ErrorDescription00014053	Illegal DOF of joint position, velocity, or acceleration
ErrorDescription00014054	Joint type mismatch
ErrorDescription00014055	Illegal link frame SN
ErrorDescription00014056	Forward kinematics calculation failed
ErrorDescription00014057	Illegal robot configuration (dimension or content)
ErrorDescription00014058	Inverse kinematics calculation failed
ErrorDescription00014059	Illegal Robot ID
ErrorDescription0001405A	At least one joint position is not in its working range
ErrorDescription0001405B	This function supports only robots with 6 DOF or above
ErrorDescription0001405C	Robot status update failed
ErrorDescription0001405D	Load robot configure file failed
ErrorDescription0001405E	Save robot configure file failed
ErrorDescription0001405F	Illegal robot configuration number
ErrorDescription00014060	This function is dummy, just used for override
ErrorDescription00014061	Jacobian calculation failed
ErrorDescription00014062	Jacobian inverse failed
ErrorDescription00014063	Speed transfer via Jacobian failed

ErrorDescription00014064	Robot is at singular point
ErrorDescription00014065	Differential orientation transfer failed
ErrorDescription00014066	The transfer between geometric and analytical Jacobian failed
ErrorDescription00014067	Forward dynamics computation failed
ErrorDescription00014068	Inertia tensor computation failed
ErrorDescription00014069	Inverse dynamics computation failed
ErrorDescription0001406A	Robot dynamic parameter ID matrix computation failed
ErrorDescription0001406B	End effector dynamic parameter ID matrix computation failed
ErrorDescription0001406C	ID parameter format cannot be formed
ErrorDescription0001406D	Cartesian/Joint space trajectory transfer failed
ErrorDescription0001406E	Acquiring equivalent axis-angle rotation matrix between two frames failed
ErrorDescription0001406F	Task/object frame establishing failed
ErrorDescription00014070	TCP calibration process initialization failed
ErrorDescription00014071	TCP calibration process initialization has done
ErrorDescription00014072	Illegal number of changing robot postures for TCP calibration
ErrorDescription00014073	TCP calibration process initialization has not done yet
ErrorDescription00014074	Record Robot posture failed in TCP calibration
ErrorDescription00014075	TCP computation failed
ErrorDescription00014076	Task frame establishing process initialization has not yet been done
ErrorDescription00014077	Task frame establishing calculation failed
ErrorDescription00014078	At least one of Position, Px, or Py is not recorded in task frame establishing process
ErrorDescription00014079	Linking task frame failed
ErrorDescription0001407A	Illegal number of task parameters
ErrorDescription0001407B	Task space coordinates transfer failed : from RTX to HMI
ErrorDescription0001407C	Task space coordinates transfer failed : from HMI to RTX
ErrorDescription0001407D	teach point transfer on task space failed
ErrorDescription0001407E	Target approaching failed
ErrorDescription0001407F	Move to target with respect to tool base failed
ErrorDescription00014080	Move to target with respect to base failed
ErrorDescription00014081	DH compensation failed
ErrorDescription00014082	DH compensation stops, this will not affect robot moving
ErrorDescription00014083	Move distance with respect to base frame failed
ErrorDescription00014084	Robot flipping failed
ErrorDescription00014085	Failed to check whether robot can flip
ErrorDescription00014086	IK solution jumping
ErrorDescription00014087	Inner workspace limit
ErrorDescription00014088	Outer workspace limit
ErrorDescription00014089	Wrist singularity
ErrorDescription0001408A	Out of outer workspace
ErrorDescription0001408B	Out of inner workspace
ErrorDescription0001408C	Infinite solution. No solution is selected
ErrorDescription0001408D	Undefined error
ErrorDescription0001408E	Homing check failed
ErrorDescription0001408F	Modify IK solution failed
ErrorDescription00014090	At least one joint position will reach boundary
ErrorDescription00014091	Check robot configuration failed
ErrorDescription000140AA	Set robot parameter from string failed

ErrorDescription000140AB	Acquiring robot flange generalized position failed
ErrorDescription000140AC	Acquiring robot tool generalized position failed
ErrorDescription000140AD	Series frames transform failed
ErrorDescription000140AE	Failed to calculate Jacobian due to DH error
ErrorDescription000140AF	Generalized Cartesian position transfer between frames failed
ErrorDescription000140B0	Load delta DH file failed
ErrorDescription000140B1	At least one joint position is not in the range , -180 deg~ 180 deg
ErrorDescription00014438	Illegal DOF of eye in hand transform
ErrorDescription00014439	Initialization of EIH calibration process failed
ErrorDescription0001443A	Initialization of EIH calibration process has not yet been done
ErrorDescription0001443B	Obtaining initial posture 'P0' failed in EIH calibration
ErrorDescription0001443C	Moving to next posture 'Pi' failed in EIH calibration
ErrorDescription0001443D	Data pattern processing failed in SCARA's EIH calibration
ErrorDescription0001443E	Forward/Inverse indexing of data pattern processing failed in SCARA's EIH calibration
ErrorDescription0001443F	EIH transform calculation failed
ErrorDescription00014440	Camera is attached with the translational axis, and it does not move
ErrorDescription00014441	Camera does not move, but image changes
ErrorDescription00014442	Current image data is invalid
ErrorDescription00014443	Initialization of camera intrinsic parameter calibration process failed
ErrorDescription00014444	There are constraints on the effective robot moving area, please change the initial robot posture or the virtual radius
ErrorDescription00014445	Initialization of camera intrinsic parameter calibration process failed
ErrorDescription00014446	Initialization of camera intrinsic parameter calibration process has not yet been done
ErrorDescription00014447	Get current robot Cartesian posture failed
ErrorDescription00014448	Change tool parameters failed
ErrorDescription00014449	Change robot tip's orientation failed
ErrorDescription0001444A	Visual move01 failed
ErrorDescription0001444B	Visual move11 failed
ErrorDescription0001444C	Visual move02 failed
ErrorDescription0001444D	EIH calibration should be done first
ErrorDescription0001444E	Inverse the interaction matrix failed
ErrorDescription0001444F	Visual move03 failed
ErrorDescription00014450	Visual move04 failed
ErrorDescription00014451	Visual move05 failed
ErrorDescription00014452	Visual move15 failed
ErrorDescription00014453	Visual move06 failed
ErrorDescription00014454	Visual move07 failed
ErrorDescription00014455	Visual move17 failed
ErrorDescription00014456	Illegal number of taking image data
ErrorDescription00014457	The link frame attached with EIH camera does not match user's definition
ErrorDescription00014458	Record each robot and camera posture in EIH calibration failed
ErrorDescription00014459	Illegal camera extrinsic parameter matrix
ErrorDescription0001445A	Illegal number of changing robot posture
ErrorDescription0001445B	Rotate around Y axis failed
ErrorDescription0001445C	Move along X axis failed
ErrorDescription0001445D	Rotate around Z axis failed
ErrorDescription0001445E	Get EIH transform failed
ErrorDescription0001445F	Set EIH transform failed



ErrorDescription00014820	Move camera to target failed
ErrorDescription00014C08	Feature point coordinates transfer (robot base frame to image frame) failed
ErrorDescription00014C09	Feature point coordinates transfer (robot base frame to camera frame) failed
ErrorDescription00014C0A	Establishing interaction matrix of a single image point failed
ErrorDescription00014C0B	The working depth on optic axis cannot be zero
ErrorDescription00014C0C	The camera focus cannot be zero
ErrorDescription00014C0D	Acquiring joint velocity command failed
ErrorDescription00014C0E	Illegal number of feature points
ErrorDescription00014C0F	Illegal number of image errors
ErrorDescription00014C10	The DOF of image point must be 2
ErrorDescription00014C11	Camera should be attached with the robot end flange.
ErrorDescription00014C12	The visual servo damping factor should be positive
ErrorDescription00014C13	Acquiring joint velocity command (via two feature points) failed
ErrorDescription00014C14	Visual servo simulation test failed
ErrorDescription00014FF0	Initialization of DH calibration process failed
ErrorDescription00014FF1	Initialization of DH calibration process has not yet been done
ErrorDescription00014FF2	Record Robot posture failed in DH calibration
ErrorDescription00014FF3	Transfer between frame 0 and (i-1) failed
ErrorDescription00014FF4	Transfer between frame i and N failed
ErrorDescription00014FF5	Transfer between frame 0 and i failed
ErrorDescription00014FF6	DH calibration calculation (for SCARA type robot) failed
ErrorDescription00014FF7	DH calibration calculation (for 6DOF type robot) failed
ErrorDescription00014FF8	Calculate DH compensation terms failed
ErrorDescription00014FF9	DH compensation failed
ErrorDescription00014FFA	DH calibration moving guided by vision failed
ErrorDescription00014FFB	TCP calibration move failed
ErrorDescription00014FFC	DH align error over 0.3 mm
ErrorDescription00014FFD	Error on joint 1-5 over 1 degree!
ErrorDescription000153D8	Acquiring parallel list position failed
ErrorDescription000153D9	In parallel list application, at least two points coincides
ErrorDescription000153DA	Parallel list number should be large than 1 in one dimension
ErrorDescription000153DB	Align the x-y plane of the robot end of flange frame with that of base frame failed
ErrorDescription000153DC	Illegal geometric plane data
ErrorDescription000153DD	Align the x-y plane of the robot end of flange frame with that of user defined frame failed
ErrorDescription000153DE	Align the x-y plane of the robot end of flange frame with that of task frame failed
ErrorDescription000153DF	Acquiring object avoidance point failed
ErrorDescription000153E0	The robot configuration does not match that used in vision system
ErrorDescription000153E1	Acquiring robot's joint position corresponding to the robot end of flange's generalized Cartesian position failed
ErrorDescription000153E2	Calculating the generalized Cartesian force acting on robot's TCP failed
ErrorDescription000153E3	Calculating the effective norm of the generalized Cartesian force acting on robot's TCP failed
ErrorDescription000157C0	Right arm failed
ErrorDescription000157C1	Left arm failed
ErrorDescription00020000	[Error][Hardware]Camera NOT found
ErrorDescription00020001	Camera in use
ErrorDescription00020002	Unexpected error
ErrorDescription00020003	[Error][Hardware]Camera is disconnected. Please check whether the connection of camera is broken or the USB slots are overloaded.

ErrorDescription00020004	Unmatched job version. The job was made by PreAPR version but current Vision is APR version
ErrorDescription00020005	[Warning][User Setting]Missing Dongle Key: ...
ErrorDescription00020006	Grab image failed
ErrorDescription00020007	Vision error
ErrorDescription00020008	[Error][Vision]Job NOT found
ErrorDescription00020009	[Error][Vision>Actioner is busy
ErrorDescription0002000A	This job can only be run on X64 platform
ErrorDescription0002000B	Servoing and Vision-IO threads conflict
ErrorDescription0002000C	[Error][Vision]Vision result save to storage fail
ErrorDescription0002000D	[Error][Vision]External HTTP setting missing
ErrorDescription0002000E	[Error][Vision]AI model missing
ErrorDescription0002000F	[Error][Vision]Image NOT found
ErrorDescription00020010	Job parameters of camera did not match
ErrorDescription00020011	Servoing thread is running
ErrorDescription00020012	[Error][Vision]GPU driver initial fail
ErrorDescription00020013	[Error][Vision]AI function computing device NOT found
ErrorDescription00020014	[Error][Vision]Selected AI model only support GPU
ErrorDescription00020015	[Error][Vision]Please go to TM official website to download and import the same GPU patch as the current TMflow version
ErrorDescription00020016	[Error][Vision]Only one IO trigger camera job can be process in this project
ErrorDescription00020017	[Error][Vision]Images store in buffer are more than 20 frames
ErrorDescription00020018	[Error][Vision]Camera trigger mode conflict
ErrorDescription00020019	[Error][Vision]This AI model version is not support
ErrorDescription0002001A	[Error][Vision]This AI model is not support the device Windows OS environment
ErrorDescription0002001B	[Error][Vision]Project include a virtual job
ErrorDescription00030001	[Error][User Setting]Invalid plane points
ErrorDescription00030002	[Error][User Setting]Invalid cube points
ErrorDescription00030003	[Error][User Setting]Failed to build operation space with the new plane
ErrorDescription00030004	[Error][User Setting]Failed to build operation space with the new stop plane
ErrorDescription00030005	Invalid selected planes
ErrorDescription00030006	Incorrect command format
ErrorDescription00030007	Detection point is out of safety space
ErrorDescription00031000	[Error][System]cannot connect to Viewer
ErrorDescription00031001	Send data to Viewer failed
ErrorDescription00031002	Receive data from Viewer failed
ErrorDescription00031003	Get invalid data from Viewer
ErrorDescription00031004	Get no data from Viewer
ErrorDescription00031005	Invalid Point
ErrorDescription00031006	Invalid Parameter
ErrorDescription00031007	Over angle limit
ErrorDescription00031008	Scene file does not exist
ErrorDescription00040000	Client is not connected to any proxy server
ErrorDescription00040001	Undefined error code
ErrorDescription00040002	HMI server error
ErrorDescription00040003	Robot is unlocked
ErrorDescription00040004	Null Exception
ErrorDescription00040005	[Error][Flow]Program Exception

ErrorDescription00040006	Write SystemFile.ini failed
ErrorDescription00040007	[Hardware][Error]Robot is not connected
ErrorDescription00040008	Illegal Privilege
ErrorDescription00040009	Log In/Out failed
ErrorDescription0004000A	[info.]Robot is locked
ErrorDescription0004000B	Set System Time failed
ErrorDescription0004000C	Set TCP failed
ErrorDescription0004000D	File Transfer failed
ErrorDescription0004000E	TCP Not Found
ErrorDescription0004000F	[Error][Software>Delete project failed
ErrorDescription00040010	Generate file error
ErrorDescription00040011	[Error][Motion]Step run failed
ErrorDescription00040012	Changed base failed
ErrorDescription00040013	[Error][Motion]Change TCP failed
ErrorDescription00040014	[Error][System]Generate Prog File failed
ErrorDescription00040015	[Warning][Hardware]Fan rpm less than 1000
ErrorDescription00040016	[User Setting][Error]Invalid Parameter
ErrorDescription00040017	Base Not Found
ErrorDescription00040018	[Error][Software]Base is in use
ErrorDescription00040019	Point Not Found
ErrorDescription0004001A	Operation Space Binding failed
ErrorDescription0004001B	Set Component List failed
ErrorDescription0004001C	[Error][Flow]Start Node Not Connected
ErrorDescription0004001D	Failed to re-record the point to another base
ErrorDescription0004001E	[Error][User Setting]User number over limit
ErrorDescription0004001F	[Error][User Setting]Ownership has been acquired
ErrorDescription00040020	Only can owner delete ownership
ErrorDescription00040021	[Error][Software]New Base failed
ErrorDescription00040022	[Error][User Setting]Compliance teach failed
ErrorDescription00040023	[Error][User Setting]Line teach failed
ErrorDescription00040024	Internal Error
ErrorDescription00040025	Incorrect Control Mode
ErrorDescription00040026	Robot Cmd failed
ErrorDescription00040027	[Error][External Device]USB Error
ErrorDescription00040028	Project Is Running
ErrorDescription00040029	Project Is Editing
ErrorDescription0004002A	[Error][Flow]Project does not exist
ErrorDescription0004002B	[System][Error]Project File Load Error
ErrorDescription0004002C	[System][Error]Project Compile failed
ErrorDescription0004002D	[Error][System]Project Run failed
ErrorDescription0004002E	[info.][System]Project Locked
ErrorDescription0004002F	[info.]Connected to a new Proxy Server
ErrorDescription00040030	Force-Torque sensor is not found
ErrorDescription00040031	[Error][External Device]Force-Torque sensor open failed
ErrorDescription00040032	Set Modbus Device failed
ErrorDescription00040033	Delete Modbus Device failed
ErrorDescription00040034	Force-Torque sensor data is not updated

ErrorDescription00040035	[Error][External Device]Force-Torque sensor data does not response
ErrorDescription00040036	[info.]Point Type is Offline
ErrorDescription00040037	[Error][System]Set watch node failed
ErrorDescription00040038	[Error]Node is in offline mode
ErrorDescription00040039	Base name is not accepted
ErrorDescription0004003A	[Error][User Setting]Over maximum loading
ErrorDescription0004003B	[Error][User Setting]Over maximum loading with TCP loading
ErrorDescription0004003C	NotActive
ErrorDescription0004003D	SendDataFail
ErrorDescription0004003E	ReceiveDataFail
ErrorDescription0004003F	InvalidReturnValue
ErrorDescription00040040	GetNoDataFromEmulator
ErrorDescription00040041	CheckOptimalSpeed
ErrorDescription00040042	Move Pose for F/T Sensor error
ErrorDescription00040043	Compute Tool Mass and Centroid for F/T Sensor error
ErrorDescription00040044	Save Tool to F/T Sensor error
ErrorDescription00040045	Step run failed because of variables parameter
ErrorDescription00040046	Out of Cartesian limits set. Please check if the TCP or elbow is out of the Cartesian limits
ErrorDescription00040047	Robot TCP and/or elbow exceeds Cartesian limit
ErrorDescription00040048	This project has existed, could not create new project
ErrorDescription00040049	The project is blocked from running due to the expiration of leasing
ErrorDescription0004004A	Path record state error
ErrorDescription0004004B	Path record fail
ErrorDescription0004004C	Invalid Nodes in TM AI+ AOI Edge
ErrorDescription0004004D	[Error] [Flow] Component object not found
ErrorDescription0004004E	[Error] [Flow] Component has motion node
ErrorDescription0004004F	[Error] [Flow] Fail to execute Component
ErrorDescription00040050	[Error] [Hardware] IO Device not found
ErrorDescription00040051	Hold to Run Error
ErrorDescription00040052	Could not set key status during Robot Stick unlocking
ErrorDescription00040053	Project cannot be executed during system error state
ErrorDescription00040054	Project cannot be executed if AUT.P port is open
ErrorDescription00040055	Project cannot be edited under AUTO MODE
ErrorDescription00040056	Project is not running
ErrorDescription00040057	Get gravity data fail
ErrorDescription00040058	Project is future version
ErrorDescription00040059	The component object is old version
ErrorDescription00040070	Safety checksum mismatch between HMI and safety parameters.
ErrorDescription00040100	Certification does not match Please download the latest certification file from website to start the installation process. The installation process will not proceed.
ErrorDescription00040101	Certification does not match Please request the certification file from the product provider, and put it under TMflow folder located under the installation directory to enable TMflow Editor. Program will be terminated automatically.
ErrorDescription00040102	[Warning][User Setting]Host and client versions conflict [Cause]The software version between the robot (host) and Tmflow.exe (client) is not matched

	[Caution]Check both versions of the robot (host) and the Tmflow.exe on PC (client) if they are matched or not
	[Precaution] If the versions are not matched, there would be possibly to trigger unexpected errors for certain functions
	[Solution]Click OK to close the pop up window
	Make sure both versions of the robot (host) and the Tmflow.exe on PC (client) are matched before login
ErrorDescription00040103	[Error][User Setting]Certification does not match. Please get the certification file from the product provider, and put it under TMflow folder located under the installation directory to enable TMflow Editor. Program will be closed automatically. [Cause]Certification for the corresponding HMI does not match [Caution]1. Check if the certification file on Techman folder is the correct version if this happens on Tmflow.exe 2. Check if the certification file on the USB drive exists or if it is the correct version for HMI update [Solution]1. Click OK to close the pop up window 2. Replace the file with the correct one Make sure the certification file is correct
ErrorDescription00040104	MD5 file is not existed.
ErrorDescription00040105	MD5 is not matched, the file may be damaged.
ErrorDescription00040F80	Server initialize failure
ErrorDescription00040F81	Server initialize failure, Listener binding error
ErrorDescription00040F82	Server initialize failure, Control mode error
ErrorDescription00040F83	Server initialize failure, Safety error
ErrorDescription00040F84	Server initialize failure, SystemFile error
ErrorDescription00040F85	Server initialize failure, Open Vision error
ErrorDescription00040F86	Server initialize failure, Open Service error
ErrorDescription00040F90	[Error] [External Device] Application Mode missing dongle key
ErrorDescription00041000	EtherCAT mode error
ErrorDescription00041001	FreeBot error
ErrorDescription00041002	[Error][System]Internal high speed communication failure
ErrorDescription00041003	[Error][Motion]Robot motion error
ErrorDescription00041004	Robot command error
ErrorDescription00041005	Robot controller error
ErrorDescription00041006	RETEX4 build failed
ErrorDescription00041007	Simulate mode error
ErrorDescription00041008	[Error][Motion]Over Working Area
ErrorDescription00041009	Rtx start failure
ErrorDescription0004100A	Rtx license failure
ErrorDescription0004100B	Robot System is not ready
ErrorDescription0004100C	Robot performed Cat.1 stop
ErrorDescription00042000	Actioner Start failed
ErrorDescription00042001	Actioner Run failed
ErrorDescription00042002	Actioner Pause failed
ErrorDescription00042003	Actioner Warning
ErrorDescription00042004	Actioner exception when Start Or Pause
ErrorDescription00042005	Actioner exception when Stop
ErrorDescription00042006	Actioner write file error
ErrorDescription00042007	Actioner code error
ErrorDescription00042008	Actioner variable type mismatch
ErrorDescription00042009	Actioner execute robot failed
ErrorDescription0004200A	Error during project warp

ErrorDescription0004200B	Variable is not found
ErrorDescription0004200C	Node missing essential property
ErrorDescription0004200D	Vision Job is not valid
ErrorDescription0004200E	Component no condition match
ErrorDescription0004200F	[Error] [Flow] IF/Gateway no condition match
ErrorDescription00042010	Missing Dongle Key
ErrorDescription00042011	Actioner is null
ErrorDescription00042012	Project is not running
ErrorDescription00042013	Project is not initialize done
ErrorDescription00042014	Set variables fail
ErrorDescription00042015	[Error] [Flow] [Link to project speed] is disabled, the velocity exceed 250 mm/s.
ErrorDescription00042016	This component could not be used in thread
ErrorDescription00042017	Cannot start project execution without choosing to save current project or not
ErrorDescription00043000	Vision server error
ErrorDescription00043001	Vision is not initialized
ErrorDescription00043002	Vision SmartPick error
ErrorDescription00043003	[Vision][Error]Vision Job file error
ErrorDescription00043004	[Vision][Error]Vision job file not found
ErrorDescription00043005	Vision command format error
ErrorDescription00043006	[Error][Hardware]Vision reply message error
ErrorDescription00043007	Vision job is not started
ErrorDescription00043008	Vision unknown command received
ErrorDescription00043009	Vision found nothing
ErrorDescription0004300A	Vision actioner time-out
ErrorDescription0004300B	[Error][VISION]Vision actioner reply data is not applicable
ErrorDescription0004300C	Vision job is already running
ErrorDescription0004300D	Vision actioner initialization fail
ErrorDescription0004300E	Vision calibration error
ErrorDescription0004300F	[Error] [Vision] Invalid function call when calling VisionActionerDO
ErrorDescription00043010	[Error] [Vision] Vision job not exist
ErrorDescription00043011	Vision command executes fail
ErrorDescription00044000	[info.]Modbus object initializing
ErrorDescription00044001	Modbus socket read
ErrorDescription00044002	Modbus error
ErrorDescription00044003	[info.][com.]Modbus data wrote
ErrorDescription00044004	Modbus data received
ErrorDescription00044005	[info.]Modbus serial port open
ErrorDescription00044200	[Error]Fieldbus device general error
ErrorDescription00044201	[Error]Fieldbus device driver error
ErrorDescription00044202	[Error]Fieldbus device communication error
ErrorDescription00044203	[Error]Fieldbus device exception error
ErrorDescription00044204	[Error] [Hardware] Failed to activate Fieldbus device. Check if the correct device and driver are installed.
ErrorDescription00044205	Setup wrong Fieldbus device firmware and config
ErrorDescription00044300	[info.]Profinet enable
ErrorDescription00044301	[info.]Profinet disabled
ErrorDescription00044302	[Error]Profinet enable fail
ErrorDescription00044303	[Error]Profinet disabled fail



ErrorDescription00044304	[Error][Com.]Profinet read fail
ErrorDescription00044305	[Error][Com.]Profinet write fail
ErrorDescription00044400	[info.]EtherCAT enable
ErrorDescription00044401	[info.]EtherCAT disabled
ErrorDescription00044402	[Error]EtherCAT enable fail
ErrorDescription00044403	[Error]EtherCAT disabled fail
ErrorDescription00044404	[Error][Com.]EtherCAT read fail
ErrorDescription00044405	[Error][Com.]EtherCAT write fail
ErrorDescription00044500	[info.]EtherNet/IP enable
ErrorDescription00044501	[info.]EtherNet/IP disabled
ErrorDescription00044502	[Error]EtherNet/IP enable fail
ErrorDescription00044503	[Error]EtherNet/IP disabled fail
ErrorDescription00044504	[Error][Com.]EtherNet/IP read fail
ErrorDescription00044505	[Error][Com.]EtherNet/IP write fail
ErrorDescription00044600	[Error] Both TMflow ROS driver and TMvision ROS driver have failed.
ErrorDescription00044601	[Error] TMflow ROS driver has failed.
ErrorDescription00044602	[Error] TMvision ROS driver has failed.
ErrorDescription00044603	[Error] TM ROS driver initializing has timeout.
ErrorDescription00044604	[Error] TM ROS driver does not exist.
ErrorDescription00045000	[Error][External Device]USB with correct name does not exist.
ErrorDescription00045001	[Error][Software]No Space for External Device
ErrorDescription00045002	No support offered
ErrorDescription00045003	[Error][com.]Data exchange failed. File may be accessed.
ErrorDescription00045004	[Error][Com.]File not found
ErrorDescription00045005	[Error][Com.]Read data file failed
ErrorDescription00045006	[Error][Com.]Client connect server failed
ErrorDescription00045007	[Error][Com.]Client connection failed
ErrorDescription00045008	[Error][Com.]Client send command failed
ErrorDescription00045009	Command timeout
ErrorDescription0004500A	[Error][Com.]TCP listener error
ErrorDescription0004500B	[Error][Com.]Configure network failed
ErrorDescription0004500C	[Hardware][Error]No Space for Application Directory
ErrorDescription0004500D	UNC path could not be access
ErrorDescription0004500E	UNC path is invalid
ErrorDescription0004500F	The network adapter is not active.
ErrorDescription00045010	Network IP is conflict
ErrorDescription00045011	No any network adapters
ErrorDescription00045020	[Warning] [System] The free space of the hard disk is less than 15G.
ErrorDescription00045021	[Error] [System] The remaining capacity of the hard disk is less than 10G.
ErrorDescription00045100	[Error][Software]Incomplete update
ErrorDescription00045101	Application update is not executed
ErrorDescription00045200	An unexpected error occurred when executing the import and export function.
ErrorDescription00045201	The import and export function cannot be executed when the project is executing
ErrorDescription00045202	Invalid file name
ErrorDescription00045203	Invalid file path
ErrorDescription00045204	File is not exist
ErrorDescription00045205	File path is not exist

ErrorDescription00045206	File is already exist
ErrorDescription00045207	No space for import and export on target side
ErrorDescription00045208	The system has not enough temporary space
ErrorDescription00045209	The system has not enough space
ErrorDescription0004520A	The external device has not enough space
ErrorDescription0004520B	Create system temporary folder failed
ErrorDescription0004520C	Create external device folder failed
ErrorDescription0004520D	Zip file failed
ErrorDescription0004520E	Unzip file failed
ErrorDescription0004520F	File copy failed
ErrorDescription00045210	File export failed
ErrorDescription00045211	File import failed
ErrorDescription00045212	Program object error
ErrorDescription00045213	Program parameter error
ErrorDescription00045214	The robot model type recorded in the safety configuration file does not match the actual robot model type
ErrorDescription00045215	The safety system version in the safety configuration file does not match the actual safety system version
ErrorDescription00045216	Delete file failed
ErrorDescription00045217	Delete folder failed
ErrorDescription00045218	File is invalid
ErrorDescription00045219	File's checksum is invalid
ErrorDescription00045240	Robot arm and control box replaceability is not supported
ErrorDescription00045241	Download calibration files fail
ErrorDescription00045242	Download calibration files invalid
ErrorDescription00045243	Calibration data invalid
ErrorDescription00045244	Calibration data different
ErrorDescription00045245	Replace calibration data fail
ErrorDescription00045246	Upload calibration files fail
ErrorDescription00045247	Collection calibration data fail
ErrorDescription00045248	Collection calibration data fail
ErrorDescription00046000	Web command error
ErrorDescription00047000	Service Engine Settings object initialization error
ErrorDescription00048000	Invalid syntax error
ErrorDescription00048001	Invalid syntax error
ErrorDescription00048002	Failed to open file during compile file
ErrorDescription00048003	Failed to read file during compile file
ErrorDescription00048004	Exception error during compile file
ErrorDescription00048005	Exception error during compile file
ErrorDescription00048006	Exception error during compile file
ErrorDescription00048080	Invalid syntax error
ErrorDescription00048081	Invalid syntax error
ErrorDescription00048082	Invalid number format
ErrorDescription00048083	Invalid string format
ErrorDescription00048084	Invalid syntax error
ErrorDescription00048100	Invalid syntax error
ErrorDescription00048101	Missing left brace {
ErrorDescription00048102	Missing right brace }
ErrorDescription00048103	Missing left bracket [



ErrorDescription00048104	Missing right bracket ]
ErrorDescription00048105	Missing left parenthesis (
ErrorDescription00048106	Missing right parentheses )
ErrorDescription00048107	Missing if condition
ErrorDescription00048108	Missing if true statements
ErrorDescription00048109	Missing if false statements
ErrorDescription0004810A	Missing switch condition
ErrorDescription0004810B	Missing switch case statements
ErrorDescription0004810C	Missing switch case or default for next expression
ErrorDescription0004810D	Duplicated switch case condition
ErrorDescription0004810E	Missing for condition
ErrorDescription0004810F	Invalid for loop format
ErrorDescription00048110	Missing while condition
ErrorDescription00048111	Missing while keyword of do-while
ErrorDescription00048112	Missing do-while condition
ErrorDescription00048113	Invalid syntax error
ErrorDescription00048114	Invalid syntax error
ErrorDescription00048115	Invalid syntax error
ErrorDescription00048116	void cannot be a data type
ErrorDescription00048117	Invalid variable declaration
ErrorDescription00048118	Invalid variable declaration with initialization
ErrorDescription00048119	Invalid function data type of parameters
ErrorDescription0004811A	Invalid array declaration
ErrorDescription0004811B	Invalid array declaration with data type
ErrorDescription0004811C	Invalid syntax error
ErrorDescription0004811D	Invalid syntax error
ErrorDescription0004811E	Invalid syntax error
ErrorDescription0004811F	Invalid expression token
ErrorDescription00048180	Invalid syntax error
ErrorDescription00048181	Duplicated function node definition
ErrorDescription00048182	Duplicated function definition
ErrorDescription00048183	Duplicated variables declaration
ErrorDescription00048184	Invalid syntax error
ErrorDescription00048185	Invalid syntax error
ErrorDescription00048186	Invalid syntax error
ErrorDescription00048187	Invalid syntax error
ErrorDescription00048188	Invalid syntax error
ErrorDescription00048189	Null namespace
ErrorDescription0004818A	Undefined namespace
ErrorDescription0004818B	Undefined function nodes
ErrorDescription0004818C	Undefined functions
ErrorDescription0004818D	Undefined variables
ErrorDescription0004818E	Invalid syntax error
ErrorDescription0004818F	Invalid syntax error
ErrorDescription00048190	Invalid syntax error
ErrorDescription00048191	Invalid syntax error
ErrorDescription00048192	Invalid syntax error

ErrorDescription00048193	Invalid return data type
ErrorDescription00048194	No return value
ErrorDescription00048195	Invalid expression
ErrorDescription00048200	Invalid syntax error
ErrorDescription00048201	Undefined variables
ErrorDescription00048202	Undefined functions
ErrorDescription00048203	Undefined classes
ErrorDescription00048204	Undefined class member or method
ErrorDescription00048205	Missing key index of group classes
ErrorDescription00048206	Invalid key index value of group classes
ErrorDescription00048207	Class operation is not allowed
ErrorDescription00048208	Function operation is not allowed
ErrorDescription00048209	Array operation is not allowed
ErrorDescription0004820A	Invalid class prototype
ErrorDescription0004820B	Invalid syntax error
ErrorDescription0004820C	Invalid array prototype
ErrorDescription0004820D	Array operation is not allowed
ErrorDescription0004820E	Array Index is not a integer number
ErrorDescription0004820F	Invalid array index
ErrorDescription00048210	Calculation operand is not a Number
ErrorDescription00048211	Calculation operand is not a Integer Number
ErrorDescription00048212	Calculation operand is not a Variables
ErrorDescription00048213	Calculation operand is not a Integer Variables
ErrorDescription00048214	Calculation operand is not a Boolean
ErrorDescription00048215	Data type is different, cannot assign operation
ErrorDescription00048216	Data type is different, cannot compare operation
ErrorDescription00048217	Data type is different, cannot compare operation
ErrorDescription00048218	Division by Zero
ErrorDescription00048219	Modulo by Zero
ErrorDescription0004821A	Invalid byte range
ErrorDescription0004821B	Invalid int range
ErrorDescription0004821C	Invalid float range
ErrorDescription0004821D	Invalid double range
ErrorDescription0004821E	Invalid Number Value
ErrorDescription0004821F	Missing Right Parentheses
ErrorDescription00048220	Missing Right Brackets
ErrorDescription00048221	Missing Right Brace
ErrorDescription00048222	Invalid syntax error
ErrorDescription00048223	Invalid syntax error
ErrorDescription00048224	Invalid syntax error
ErrorDescription00048600	Exception error
ErrorDescription00048601	Undefined variables
ErrorDescription00048602	Undefined functions
ErrorDescription00048603	Division by Zero
ErrorDescription00048604	Modulo by Zero
ErrorDescription00048605	Array operation is not allowed
ErrorDescription00048606	Invalid array index

ErrorDescription00048607	Invalid Number Value
ErrorDescription00048608	Invalid Type Value
ErrorDescription00048609	Data type is different, cannot assign operation
ErrorDescription0004860A	Data type is different, cannot compare operation
ErrorDescription0004860B	Data type is different, cannot compare operation
ErrorDescription00048610	Stack overflow
ErrorDescription00048A00	Could not Play if Previous Project is not stopped
ErrorDescription00048B00	Exception error
ErrorDescription00048B01	Invalid Type Value
ErrorDescription00048B02	Invalid Index Value
ErrorDescription00048B03	Error on Set BreakPoints
ErrorDescription00048B10	Undefined variables
ErrorDescription00048B11	Undefined functions
ErrorDescription00048B12	functions is not exist
ErrorDescription00048B13	Invalid array index
ErrorDescription00048B14	Array data type is different, could not operation
ErrorDescription00048B15	Array size is max
ErrorDescription00048B16	Array start index is invalid
ErrorDescription00048B17	Invalid Number Value
ErrorDescription00048B20	UNC Path is not allowed
ErrorDescription00048B21	UNC Path could not be access
ErrorDescription00048B22	File operation error
ErrorDescription00048B23	File read error
ErrorDescription00048B24	File create error
ErrorDescription00048B25	File write error
ErrorDescription00048B26	File delete error
ErrorDescription00048B27	File does not exist
ErrorDescription00048B28	File size is too large
ErrorDescription00048B29	File is read only
ErrorDescription00048B2A	Vision Images folder is not exist
ErrorDescription00048B2B	Vision Images UNC Path is not allowed
ErrorDescription00048B30	Serial Port open failed
ErrorDescription00048B31	Network device or IP address port is invalid
ErrorDescription00048B32	Modbus open failed
ErrorDescription00048B33	Modbus read failed
ErrorDescription00048B34	Modbus write failed
ErrorDescription00048B35	Force-Torque sensor open failed
ErrorDescription00048B36	Ethernet Slave (TCP/IP Server) is disabled
ErrorDescription00048B37	Ethernet Slave (TCP/IP Server) Item name does not exist
ErrorDescription00048B38	Ethernet Slave (TCP/IP Server) Item value is error
ErrorDescription00048B40	Parameterized key is not exist
ErrorDescription00048B41	Parameterized value is invalid
ErrorDescription00048B42	Parameterized property is not support
ErrorDescription00048B43	Parameterized Safety need HW3.2 or above
ErrorDescription00048B50	The function syntax could not called in thread
ErrorDescription00048B51	The function syntax could not called in TM AI+ AOI Edge
ErrorDescription00048B52	Invalid Motion Parameter value for Expression motion function

ErrorDescription00048B53	Invalid Parameter value for Expression function
ErrorDescription00048E00	Warning
ErrorDescription00048E01	Warning Counter
ErrorDescription00048E02	Warning for String Format with missing double quotation marks
ErrorDescription00048E03	Warning for Number Format to String Format
ErrorDescription00048E04	Warning for String Format To Number Format
ErrorDescription00048E05	Warning for Number Value possible loss
ErrorDescription00048E06	Warning for String Format include Variables
ErrorDescription00048E07	Warning for String Format include Variables
ErrorDescription00048E08	Warning for Number Value possible loss
ErrorDescription00048F00	Warning for Network path could not be access
ErrorDescription00048F01	Warning for file size is too large
ErrorDescription0004E000	Exception Error
ErrorDescription0004E001	Exception Error
ErrorDescription0004E002	[Error][Safety] Initialization Fail
ErrorDescription0004E003	Safety settings Apply Fail
ErrorDescription0004E004	Safety settings Get Fail
ErrorDescription0004E005	[Error][Safety] Safety settings Update Fail
ErrorDescription0004E006	Safety settings Confirm Fail
ErrorDescription0004E007	Safety Login Fail
ErrorDescription0004E008	Safety Login Duplicated
ErrorDescription0004E009	Safety Login Duplicated
ErrorDescription0004E00A	Safety Not Login
ErrorDescription0004E00B	Safety Logout Fail
ErrorDescription0004E00C	Safety Password Setting Fail
ErrorDescription0004E00D	Safety Password Verification Fail
ErrorDescription0004E00E	Invalid Safety Password
ErrorDescription0004E00F	Robot Operation Mode Change Fail
ErrorDescription0004E010	Robot Stick Enable/disabled Status Change Fail
ErrorDescription0004E011	Reset Safety Password Fail
ErrorDescription0004E012	Safety Module Information Get Fail
ErrorDescription0004E013	[Error][Safety] Safety Module Information Update Fail
ErrorDescription0004E014	Safety settings Update Fail
ErrorDescription0004E015	Safety Command Setting Get Fail
ErrorDescription0004E016	[Error][Safety] Safety Parameters Mismatch
ErrorDescription0004E017	[Error][Safety] Safety Module Versions Mismatch
ErrorDescription0004E018	[Error][Safety] Safety System Version Mismatch
ErrorDescription0004E019	[Error][Safety] Safety System Version Changed
ErrorDescription0004E01A	[Error][Safety] Safety Passwords Mismatch
ErrorDescription0004E01B	Safety Time Stamp Setting Fail
ErrorDescription0004E01C	Safety Calibration File Apply Fail
ErrorDescription0004E01D	Safety Calibration File Missing
ErrorDescription0004E01E	Safety Calibration Data Get Fail
ErrorDescription0004E01F	Invalid Safety Configuration File Name
ErrorDescription0004E020	Invalid Safety Configuration File Path
ErrorDescription0004E021	Safety Configuration File Save Fail
ErrorDescription0004E022	Safety Configuration File Save Fail

ErrorDescription0004E023	Safety Configuration File Load Fail
ErrorDescription0004E024	Safety Configuration File Load Fail
ErrorDescription0004E025	Safety Configuration File Delete Fail
ErrorDescription0004E026	Safety Configuration File Delete Fail
ErrorDescription0004E027	Safety System Version Mismatch between Safety Configuration File and Current Operation Safety System
ErrorDescription0004E028	Set Com Port Fail
ErrorDescription0004E029	[Error][Safety] Safety Module Serial Port Not Working
ErrorDescription0004F000	Common Info
ErrorDescription00050000	No Error
ErrorDescription0005F051	The current in U phase of motor is too high
ErrorDescription0005F052	The current in V phase of motor is too high
ErrorDescription0005F053	The current in W phase of motor is too high
ErrorDescription0005F054	Overcurrent in DCBUS
ErrorDescription0005F055	The voltage on DCBUS is too low
ErrorDescription0005F056	The voltage on DCBUS is too high
ErrorDescription0005F057	The compensation of ADC drift is out of limit
ErrorDescription0005F058	1.65V out of limit
ErrorDescription0005F059	12V out of limit
ErrorDescription0005F05A	6V out of limit
ErrorDescription0005F05B	3.3V out of limit
ErrorDescription0005F05C	1.2V out of limit
ErrorDescription0005F05D	Power supply status error
ErrorDescription0005F061	The speed command is too large
ErrorDescription0005F062	The deviation between target and current position is too large
ErrorDescription0005F063	Motor hold protection: duty command over
ErrorDescription0005F064	Motor hold protection: current feedback over
ErrorDescription0005F071	Gate Driver diagnosis error
ErrorDescription0005F072	The temperature of PCB is too high
ErrorDescription0005F073	The acceleration of G sensor is out of range
ErrorDescription0005F074	EEPROM polling timeout
ErrorDescription0005F075	Dual encoder deviation too large
ErrorDescription0005F0A4	Flash mismatch among L0 and SL1/2
ErrorDescription0005F0A5	CM error (warning)
ErrorDescription0005F0A6	ESI and EEPROM SN mismatch (warning)
ErrorDescription0005F111	EEPROM data load fail
ErrorDescription0005F112	G sensor initialization fail
ErrorDescription0005F113	Gate driver set fail
ErrorDescription0005F114	Power supply status error
ErrorDescription0005F115	Encoder architecture mismatch
ErrorDescription0005F116	Find zone of absolute position fail
ErrorDescription0005F117	Absolute position mapping Error
ErrorDescription0005F118	Absolute position over limit at startup
ErrorDescription0005F119	The resistance of UVW of motor is abnormal
ErrorDescription0005F11A	The connection of UVW of motor is not correct
ErrorDescription0005F11B	Encoder connection failed
ErrorDescription0005F11C	Encoder diagnosis error during init process
ErrorDescription0005F121	Runin: DCBus V calibration fail

ErrorDescription0005F122	Runin: G sensor calibration process is NG
ErrorDescription0005F123	Runin: G sensor calibration result is out of limit
ErrorDescription0005F124	Runin: Encoder check fail: Z signal is abnormal
ErrorDescription0005F125	Runin: Encoder check fail: AB signal is NG
ErrorDescription0005F126	Runin: Encoder check fail: the sequence of UVW wire is reverse
ErrorDescription0005F127	Runin: Index calibration process fail
ErrorDescription0005F128	Runin: index calibration result fail
ErrorDescription0005F129	"Z search" timeout
ErrorDescription0005F12A	Runin: Multiturn calibration fail
ErrorDescription0005F12B	The parameters of joint module are abnormal
ErrorDescription0005F131	Illegal interrupt to MCU
ErrorDescription0005F132	The watchdog of MCU is timeout
ErrorDescription0005F133	S48V drop
ErrorDescription0005F134	The communication of EtherCAT is timeout
ErrorDescription0005F135	Joint movement range is NG in brake release status
ErrorDescription0005F136	Brake off current is abnormal
ErrorDescription0005F137	S48V under low lim
ErrorDescription0005F138	S48V over high lim
ErrorDescription0005F139	M48V drop
ErrorDescription0005F141	Encoder 1 diagnosis error
ErrorDescription0005F142	Encoder 2 diagnosis error
ErrorDescription0005F143	Encoder 3 diagnosis error
ErrorDescription0005F144	Encoder 4 diagnosis error
ErrorDescription0005F145	Input side Encoder miss Z signal
ErrorDescription0005F146	Input side Encoder detect multiple Z signals in single-turn
ErrorDescription0005F147	Output side Encoder miss Z signal
ErrorDescription0005F148	Output side Encoder detect multiple Z signals in single-turn
ErrorDescription0005F149	Switch target encoder fail
ErrorDescription0005F1A1	FW version doesn't match HW version
ErrorDescription0005F1A2	CM FW version doesn't match CPU1 FW version
ErrorDescription0005F1A3	Flash history record load fail
ErrorDescription0005F1A7	FW and EEPROM type mismatch
ErrorDescription0005FF20	[Error][Hardware]Solenoid current is NG
ErrorDescription0005FF21	[Error][Hardware]Joint movement range is NG in brake release status
ErrorDescription0005FFA0	[Error][Hardware]The voltage on DCBUS is too low (40V)
ErrorDescription0005FFA1	[Error][Hardware]The voltage on DCBUS is too high (60V)
ErrorDescription0005FFA2	The acceleration on X direction of G sensor is out of range
ErrorDescription0005FFA3	The acceleration on Y direction of G sensor is out of range
ErrorDescription0005FFA4	The acceleration on Z direction of G sensor is out of range
ErrorDescription0005FFA5	[Error][Hardware]The temperature on PCB is too high (90 degree Celsius)
ErrorDescription0005FFA6	[Error][Hardware]The current in U phase of motor is too high
ErrorDescription0005FFA7	[Error][Hardware]The current in V phase of motor is too high
ErrorDescription0005FFA8	[Error][Hardware]The current in W phase of motor is too high
ErrorDescription0005FFA9	The overcurrent is protected by current sensor of U phase
ErrorDescription0005FFAA	The overcurrent is protected by current sensor of V phase
ErrorDescription0005FFAB	[Error][Hardware]The protection is on for motor hold
ErrorDescription0005FFAC	The initial angle of three phase of motor is not correct



ErrorDescription0005FFAD	The index angle of encoder is not calibrated
ErrorDescription0005FFAE	[Error][Hardware]Overcurrent in DCBUS
ErrorDescription0005FFAF	[Error][System]The communication of EtherCAT is timeout
ErrorDescription0005FFB1	[Error][System]The communication of SPI is timeout
ErrorDescription0005FFB2	Illegal interrupt to MCU
ErrorDescription0005FFB3	The watchdog of MCU is timeout
ErrorDescription0005FFB4	The initialization of joint coordinate is timeout
ErrorDescription0005FFB5	FW version doesn't match HW version
ErrorDescription0005FFB6	The process in main loop is timeout
ErrorDescription0005FFB7	Brake release failed.
ErrorDescription0005FFB8	[Error][Hardware]Gate Driver NG
ErrorDescription0005FFB9	[Error][Hardware]MOSFET NG
ErrorDescription0005FFBA	[Error][Hardware]Current Sensor NG
ErrorDescription0005FFC0	The deviation is too high when initializing joint coordinate
ErrorDescription0005FFC1	Runin process R2: Z index miss
ErrorDescription0005FFC2	Runin process R2: multi Z index happened
ErrorDescription0005FFC3	Runin process R2: U signal NG
ErrorDescription0005FFC4	Runin process R2: V signal NG
ErrorDescription0005FFC5	Runin process R2: W signal NG
ErrorDescription0005FFC6	Runin process R2: the sequence of UVW is NG
ErrorDescription0005FFC7	Runin process R2: AB signal is NG
ErrorDescription0005FFC8	Failure in loading data from EEPROM
ErrorDescription0005FFC9	The electrical angle of motor is not correct (warning)
ErrorDescription0005FFCA	[Error][Hardware]Multi Z index happened in encoder output
ErrorDescription0005FFCB	The deviation between command and current position is too high
ErrorDescription0005FFCC	[Error][Hardware]The Z index signal is missing
ErrorDescription0005FFCD	[Error][Hardware]Encoder connection failed
ErrorDescription0005FFCE	[Error][Hardware]The compensation of encoder signal is too high
ErrorDescription0005FFCF	[Error][Hardware]The protection is on for motor hold (type 2)
ErrorDescription0005FFD0	The UVW signal of encoder is NG
ErrorDescription0005FFD1	[Error][Hardware]The data is abnormal when reading magnetic encoder.
ErrorDescription0005FFD2	[Error][Hardware]The magnet is NG judged by magnetic encoder
ErrorDescription0005FFD3	[Error][Hardware]The origin of joint module is out of preset
ErrorDescription0005FFD4	The data in EEPROM is dislocated
ErrorDescription0005FFD5	The parameters for joint module are abnormal
ErrorDescription0005FFD6	The process of I2C control flow is out of control
ErrorDescription0005FFD7	Runin process R2: index calibration failed
ErrorDescription0005FFD8	[Hardware][Error]The resistance of UVW of motor is abnormal
ErrorDescription0005FFD9	[Hardware][Error]The connection of UVW of motor is not correct
ErrorDescription0005FFDA	Runin process R2: the current in UVW phase is NG
ErrorDescription0005FFDB	Runin process R4: UVW calibration result is out of limit
ErrorDescription0005FFDC	Runin process : G sensor calibration result is out of limit
ErrorDescription0005FFDD	a error occurs when command changes the control mode.
ErrorDescription0005FFDE	Changing EtherCAT ESM when PDS is in OP mode
ErrorDescription0005FFDF	Unknown EtherCAT ESM command
ErrorDescription0005FFE0	[Hardware][Error]The voltage of DC bus is low in EtherCAT OP mode
ErrorDescription0005FFE1	Online multiturn calibration failed

ErrorDescription0005FFE2	The magnetic encoder data is not stable in the position initialization process
ErrorDescription0005FFE3	The joint angle between "power on" and "position initialization" exceeds limit
ErrorDescription0005FFE4	[Error][System]The position initialization process is timeout ("Z search" is not finished)
ErrorDescription0005FFE5	The position initialization process is timeout
ErrorDescription0005FFE6	The result is NG in position initialization process
ErrorDescription0005FFE7	Runin process: the process of g sensor calibration is NG
ErrorDescription0005FFE8	[Hardware][Error]The output of g sensor is NG
ErrorDescription0005FFE9	The check sum result from EEPROM data is abnormal
ErrorDescription0005FFEA	[Hardware][Error]The voltage of 5V is NG
ErrorDescription0005FFEB	[Hardware][Error]The voltage of 12V is NG
ErrorDescription0005FFEC	The ADC compensation is out of limit
ErrorDescription0005FFED	[Error][Hardware]The compensation of encoder signal is too high in ABS mode
ErrorDescription0005FFEE	The deviation is too high between latching index and position initialization process
ErrorDescription0005FFEF	The parameters of magnetic encoder are abnormal
ErrorDescription0006AA11	RAM M0 march error
ErrorDescription0006AA12	RAM M1 march error
ErrorDescription0006AA13	RAM LS0 march error
ErrorDescription0006AA14	RAM LS1 march error
ErrorDescription0006AA15	RAM LS2 march error
ErrorDescription0006AA16	RAM LS3 march error
ErrorDescription0006AA17	RAM LS4 march error
ErrorDescription0006AA18	RAM LS5 march error
ErrorDescription0006AA19	RAM LS6 march error
ErrorDescription0006AA1A	RAM LS7 march error
ErrorDescription0006AA1B	RAM GS0-1 march error
ErrorDescription0006AA1C	RAM GS0-2 march error
ErrorDescription0006AA1D	RAM GS1-1 march error
ErrorDescription0006AA1E	RAM GS1-2 march error
ErrorDescription0006AA1F	RAM GS2-1 march error
ErrorDescription0006AA21	RAM GS2-2 march error
ErrorDescription0006AA22	RAM GS3-1 march error
ErrorDescription0006AA23	RAM GS3-2 march error
ErrorDescription0006AA24	SWBIST error
ErrorDescription0006AA25	SWBIST error
ErrorDescription0006AA2C	HWBIST error
ErrorDescription0006AA2E	Flash ECC error
ErrorDescription0006AA2F	Flash CRC error
ErrorDescription0006AA33	Watchdog timeout
ErrorDescription0006AA34	Sync step timeout
ErrorDescription0006AA35	Sync step timeout
ErrorDescription0006AA36	Sync step timeout
ErrorDescription0006AA37	Wrong Logic ID detected
ErrorDescription0006AA38	Timer0 INT out of range
ErrorDescription0006AA39	Timer0 INT out of range
ErrorDescription0006AA3A	Timer1 INT out of range
ErrorDescription0006AA3B	Timer1 INT out of range
ErrorDescription0006AA3C	Async digital input



ErrorDescription0006BB11	Cross check timeout
ErrorDescription0006BB12	Cross check timeout
ErrorDescription0006BB13	Cross check timeout
ErrorDescription0006BB14	Cross check timeout
ErrorDescription0006BB15	Cross check timeout
ErrorDescription0006BB16	Cross check timeout
ErrorDescription0006BB17	CRC cross check error
ErrorDescription0006BB18	CRC cross check error
ErrorDescription0006BB19	Cross check timeout
ErrorDescription0006BB1A	Tmsafe frame error
ErrorDescription0006BB1B	Tmsafe slave ID error
ErrorDescription0006BB1C	ADC cross check error
ErrorDescription0006BB1D	ADC cross check error
ErrorDescription0006BB1E	QEP cross check error
ErrorDescription0006BB1F	SL version mismatch
ErrorDescription0006CC11	1.2V out of range
ErrorDescription0006CC12	1.2V out of range
ErrorDescription0006CC13	3.3V out of range
ErrorDescription0006CC14	3.3V out of range
ErrorDescription0006CC15	1.2V out of range
ErrorDescription0006CC16	1.2V out of range
ErrorDescription0006CC17	3.3V out of range
ErrorDescription0006CC18	48V out of range
ErrorDescription0006CC1B	48V out of range
ErrorDescription0006CC1C	48V out of range
ErrorDescription0006CC1D	12V out of range
ErrorDescription0006CC1E	12V out of range
ErrorDescription0006CC1F	6V out of range
ErrorDescription0006CC21	6V out of range
ErrorDescription0006CC22	5V out of range
ErrorDescription0006CC23	5V out of range
ErrorDescription0006CC24	5V out of range
ErrorDescription0006CC25	5V out of range
ErrorDescription0006DD15	1.2V self check error
ErrorDescription0006DD16	3.3V self check error
ErrorDescription0006DD17	1.2V self check error
ErrorDescription0006DD18	48V self check error
ErrorDescription0006DD1A	48V self check error
ErrorDescription0006DD1B	12V self check error
ErrorDescription0006DD1C	6V self check error
ErrorDescription0006DD1D	1.9V self check error
ErrorDescription0006DD1E	Device temperature self check error
ErrorDescription0006DD1F	Device temperature self check error
ErrorDescription0006DD21	encoder 1 self check error
ErrorDescription0006DD22	encoder 2 self check error
ErrorDescription0006DD23	encoder 3 self check error
ErrorDescription0006DD24	3-phase current error

ErrorDescription0006DD25	3-phase current error
ErrorDescription0006DD26	3-phase current error
ErrorDescription0006DD27	3-phase current error
ErrorDescription0006DD28	encoder cross check error
ErrorDescription0006DD29	encoder 1 latch signal error
ErrorDescription0006DD2A	encoder 2 latch signal error
ErrorDescription0006DD2B	encoder 1 cross check error
ErrorDescription0006DD2C	encoder 2 cross check error
ErrorDescription0006DD2D	5V cross check error
ErrorDescription0006DD2E	5V cross check error
ErrorDescription0006EE11	Safety parameter timeout
ErrorDescription0006EE12	Invalid Safety parameter
ErrorDescription0006EE13	Encoder SSI read fail
ErrorDescription0006EE14	Safety parameter load fail
ErrorDescription0006EE15	Previous position mismatch
ErrorDescription0006EE16	Previous position mismatch
ErrorDescription0006EE17	Previous position mismatch
ErrorDescription0006EE18	Tmsafe command error
ErrorDescription0006EE19	Encoder init timeout
ErrorDescription0006EE1A	absolute position initialization timeout
ErrorDescription0006EE1B	Encoder SSI cross check fail
ErrorDescription0006F003	Previous position mismatch
ErrorDescription0006F004	Absolute position mismatch
ErrorDescription0006F005	Previous position read fail
ErrorDescription0006F00E	Fail to map 2-side encoder
ErrorDescription0006F01A	Fail to map 2-side encoder
ErrorDescription00070000	No Random Fault
ErrorDescription00070100	TMsafe Unexpected Cmd
ErrorDescription00070101	TMsafe Unknown Cmd
ErrorDescription00070102	TMsafe Invalid Connection ID
ErrorDescription00070103	TMsafe CRC Error
ErrorDescription00070104	TMsafe Watchdog Expired
ErrorDescription00070105	TMsafe Invalid FSOE Slave Address
ErrorDescription00070106	TMsafe Invalid Safe Data
ErrorDescription00070107	TMsafe Invalid Communication Parameter Length
ErrorDescription00070108	TMsafe Invalid Communication Parameter Data
ErrorDescription00070109	TMsafe Invalid Application Parameter Length
ErrorDescription0007010A	TMsafe Invalid Application Parameter Data
ErrorDescription0007010B	TMsafe Reset Cmd
ErrorDescription00070111	TMsafe Unexpected Cmd, Joint 1
ErrorDescription00070112	TMsafe Unexpected Cmd, Joint 2
ErrorDescription00070113	TMsafe Unexpected Cmd, Joint 3
ErrorDescription00070114	TMsafe Unexpected Cmd, Joint 4
ErrorDescription00070115	TMsafe Unexpected Cmd, Joint 5
ErrorDescription00070116	TMsafe Unexpected Cmd, Joint 6
ErrorDescription00070121	TMsafe Unknown Cmd, Joint 1
ErrorDescription00070122	TMsafe Unknown Cmd, Joint 2

ErrorDescription00070123	TMsafe Unknown Cmd, Joint 3
ErrorDescription00070124	TMsafe Unknown Cmd, Joint 4
ErrorDescription00070125	TMsafe Unknown Cmd, Joint 5
ErrorDescription00070126	TMsafe Unknown Cmd, Joint 6
ErrorDescription00070131	TMsafe Invalid Connection ID, Joint 1
ErrorDescription00070132	TMsafe Invalid Connection ID, Joint 2
ErrorDescription00070133	TMsafe Invalid Connection ID, Joint 3
ErrorDescription00070134	TMsafe Invalid Connection ID, Joint 4
ErrorDescription00070135	TMsafe Invalid Connection ID, Joint 5
ErrorDescription00070136	TMsafe Invalid Connection ID, Joint 6
ErrorDescription00070141	TMsafe Watchdog Expired, Joint 1
ErrorDescription00070142	TMsafe Watchdog Expired, Joint 2
ErrorDescription00070143	TMsafe Watchdog Expired, Joint 3
ErrorDescription00070144	TMsafe Watchdog Expired, Joint 4
ErrorDescription00070145	TMsafe Watchdog Expired, Joint 5
ErrorDescription00070146	TMsafe Watchdog Expired, Joint 6
ErrorDescription00070151	TMsafe Invalid FSOE Slave Address, Joint 1
ErrorDescription00070152	TMsafe Invalid FSOE Slave Address, Joint 2
ErrorDescription00070153	TMsafe Invalid FSOE Slave Address, Joint 3
ErrorDescription00070154	TMsafe Invalid FSOE Slave Address, Joint 4
ErrorDescription00070155	TMsafe Invalid FSOE Slave Address, Joint 5
ErrorDescription00070156	TMsafe Invalid FSOE Slave Address, Joint 6
ErrorDescription00070161	TMsafe Invalid Safe Data, Joint 1
ErrorDescription00070162	TMsafe Invalid Safe Data, Joint 2
ErrorDescription00070163	TMsafe Invalid Safe Data, Joint 3
ErrorDescription00070164	TMsafe Invalid Safe Data, Joint 4
ErrorDescription00070165	TMsafe Invalid Safe Data, Joint 5
ErrorDescription00070166	TMsafe Invalid Safe Data, Joint 6
ErrorDescription00070171	TMsafe Invalid Communication Parameter Length, Joint 1
ErrorDescription00070172	TMsafe Invalid Communication Parameter Length, Joint 2
ErrorDescription00070173	TMsafe Invalid Communication Parameter Length, Joint 3
ErrorDescription00070174	TMsafe Invalid Communication Parameter Length, Joint 4
ErrorDescription00070175	TMsafe Invalid Communication Parameter Length, Joint 5
ErrorDescription00070176	TMsafe Invalid Communication Parameter Length, Joint 6
ErrorDescription00070181	TMsafe Invalid Communication Parameter Data, Joint 1
ErrorDescription00070182	TMsafe Invalid Communication Parameter Data, Joint 2
ErrorDescription00070183	TMsafe Invalid Communication Parameter Data, Joint 3
ErrorDescription00070184	TMsafe Invalid Communication Parameter Data, Joint 4
ErrorDescription00070185	TMsafe Invalid Communication Parameter Data, Joint 5
ErrorDescription00070186	TMsafe Invalid Communication Parameter Data, Joint 6
ErrorDescription00070191	TMsafe Invalid Application Parameter Length, Joint 1
ErrorDescription00070192	TMsafe Invalid Application Parameter Length, Joint 2
ErrorDescription00070193	TMsafe Invalid Application Parameter Length, Joint 3
ErrorDescription00070194	TMsafe Invalid Application Parameter Length, Joint 4
ErrorDescription00070195	TMsafe Invalid Application Parameter Length, Joint 5
ErrorDescription00070196	TMsafe Invalid Application Parameter Length, Joint 6
ErrorDescription000701A1	TMsafe Invalid Application Parameter Data, Joint 1

ErrorDescription000701A2	TMsafe Invalid Application Parameter Data, Joint 2
ErrorDescription000701A3	TMsafe Invalid Application Parameter Data, Joint 3
ErrorDescription000701A4	TMsafe Invalid Application Parameter Data, Joint 4
ErrorDescription000701A5	TMsafe Invalid Application Parameter Data, Joint 5
ErrorDescription000701A6	TMsafe Invalid Application Parameter Data, Joint 6
ErrorDescription000701B1	TMsafe Reset Cmd, Joint 1
ErrorDescription000701B2	TMsafe Reset Cmd, Joint 2
ErrorDescription000701B3	TMsafe Reset Cmd, Joint 3
ErrorDescription000701B4	TMsafe Reset Cmd, Joint 4
ErrorDescription000701B5	TMsafe Reset Cmd, Joint 5
ErrorDescription000701B6	TMsafe Reset Cmd, Joint 6
ErrorDescription000701F1	TMsafe Invalid FSOE Slave Address, Joint 1
ErrorDescription000701F2	TMsafe Invalid FSOE Slave Address, Joint 2
ErrorDescription000701F3	TMsafe Invalid FSOE Slave Address, Joint 3
ErrorDescription000701F4	TMsafe Invalid FSOE Slave Address, Joint 4
ErrorDescription000701F5	TMsafe Invalid FSOE Slave Address, Joint 5
ErrorDescription000701F6	TMsafe Invalid FSOE Slave Address, Joint 6
ErrorDescription00070200	[Error][Safety] Safety inputs discrepancy detected in ES ports
ErrorDescription00070201	[Error][Safety] Safety inputs discrepancy detected in SFG ports
ErrorDescription00070202	[Error][Safety] Safety inputs discrepancy detected in SI2 ports
ErrorDescription00070203	[Error][Safety] Safety inputs discrepancy detected in SI3 ports
ErrorDescription00070204	[Error][Safety] Safety inputs discrepancy detected in SI4 ports
ErrorDescription00070205	[Error][Safety] Safety inputs discrepancy detected in SI5 ports
ErrorDescription00070206	[Error][Safety] Safety inputs discrepancy detected in SI6 ports
ErrorDescription00070207	[Error][Safety] Safety inputs discrepancy detected in SI7 ports
ErrorDescription00070208	[Error][Safety] Safety inputs discrepancy detected on Robot Stick Emergency Stop Button
ErrorDescription00070209	[Error][Safety] Safety inputs discrepancy detected on Robot Stick Enabling Switch
ErrorDescription00070210	[Error][Safety] Safety inputs discrepancy detected on Robot Stick Reset Button
ErrorDescription00070300	[Error][Safety] Safety outputs discrepancy detected in SO0 ports
ErrorDescription00070301	[Error][Safety] Safety outputs discrepancy detected in SO1 ports
ErrorDescription00070302	[Error][Safety] Safety outputs discrepancy detected in SO2 ports
ErrorDescription00070303	[Error][Safety] Safety outputs discrepancy detected in SO3 ports
ErrorDescription00070304	[Error][Safety] Safety outputs discrepancy detected in SO4 ports
ErrorDescription00070305	[Error][Safety] Safety outputs discrepancy detected in SO5 ports
ErrorDescription00070306	[Error][Safety] Safety outputs discrepancy detected in SO6 ports
ErrorDescription00070307	[Error][Safety] Safety outputs discrepancy detected in SO7 ports
ErrorDescription00070400	STO Failure
ErrorDescription00070500	Clock Failure From Supervisor
ErrorDescription00070600	Safety Logic Failure
ErrorDescription00070601	Safety Logic SPI Failure
ErrorDescription00070602	Safety Logic SCI Failure
ErrorDescription00070603	Safety Logic EFUSE Failure
ErrorDescription00070604	Safety Logic TIMER Failure
ErrorDescription00070605	Safety Logic CLOCK Failure
ErrorDescription00070606	Safety Logic CPU Failure
ErrorDescription00070607	Safety Logic ePIE Failure
ErrorDescription00070608	Safety Logic FLASH Failure

ErrorDescription00070609	Safety Logic RAM Failure
ErrorDescription0007060A	Safety Logic CLOCK OSC_HR Failure
ErrorDescription0007060B	Safety Logic CLOCK OSC_CT Failure
ErrorDescription0007060C	Safety Logic SPI Tx Failure
ErrorDescription0007060D	Safety Logic SPI Rx Failure
ErrorDescription00070700	Power Supply PSU 48V Failure From Supervisor
ErrorDescription00070701	Power Supply A24V Failure From Supervisor
ErrorDescription00070702	Power Supply PA5V Failure From Supervisor
ErrorDescription00070703	Power Supply 3.3V Failure From Supervisor
ErrorDescription00070704	Power Supply 1.2V Failure From Supervisor
ErrorDescription00070705	Power Supply SF24V Failure From Supervisor
ErrorDescription00070800	Configuration Tool Failure
ErrorDescription00070801	Configuration Tool Timeout Failure
ErrorDescription00070900	Supervisor Failure
ErrorDescription00070A00	Firmware Procedure Design Failure
ErrorDescription00070A01	SPI Process Failure
ErrorDescription00070A02	Logic state Failure
ErrorDescription00070B00	TMsafe slave HW Failure
ErrorDescriptionF0000001	The Auto Remote Mode button can only be used under Auto Mode.
ErrorDescriptionF0000002	Please switch to Auto Mode , Get control permission and make sure no project is running to use. For switching between Auto Mode and Auto Remote Mode, please make sure the following terms: 1. No project is running. 2. Get robot control permission under Auto Mode. 3. Click the Auto Remote Mode button.
ErrorDescriptionF0000020	Network Service Command Error
ErrorDescriptionF0000021	UNC format is wrong
ErrorDescriptionF0000022	Invalid Period
ErrorDescriptionF0000023	Invalid Time
ErrorDescriptionF0000024	Login pass
ErrorDescriptionF0000025	Login fail
ErrorDescriptionF0000026	Logout pass
ErrorDescriptionF0000027	Logout fail
ErrorDescriptionF0000028	Over the number of log upload allowed
ErrorDescriptionF0000029	Over the number of robot data allowed
ErrorDescriptionF000002A	Over the number of vision images allowed
ErrorDescriptionF000002B	Over the number of UNC Setting
ErrorDescriptionF000002C	UNC is duplicated
ErrorDescriptionF0000040	Maintenance mode command error
ErrorDescriptionF0000041	Maintenance mode missing dongle key
ErrorDescriptionF0000042	Calibration project is not exist
ErrorDescriptionF0000043	Calibration project name is duplicated
ErrorDescriptionF0000044	Robot is not ready to active
ErrorDescriptionF0000045	Get robot posture fail
ErrorDescriptionF0000046	Robot ID is not setting
ErrorDescriptionF0000047	File is not exist
ErrorDescriptionF0000048	Get file fail

ErrorDescriptionF0000049	Drive disk is not TM Robot brand
ErrorDescriptionF0000060	File checksum or form type error
ErrorDescriptionF0000061	File path/name error
ErrorDescriptionF0000062	Program object error
ErrorDescriptionF0000063	File's version error
ErrorDescriptionF0000064	File's form type error
ErrorDescriptionF0000065	Communicate Mode error
ErrorDescriptionF0000066	User-defined item exceeds limit
ErrorDescriptionF0000067	Item's name is invalid
ErrorDescriptionF0000068	Item's name is duplicate
ErrorDescriptionF0000069	Item's data type is invalid
ErrorDescriptionF000006A	Item's data length is invalid
ErrorDescriptionF000006B	Item's data accessibility is invalid
ErrorDescriptionF000006C	Item's data writable mode is invalid
ErrorDescriptionF000006D	File save fail
ErrorDescriptionF000006E	Program Exception
ErrorDescriptionF0000080	Error while IODD xml file loading
ErrorDescriptionF0000081	Invalid IODD xml file format
ErrorDescriptionF0000082	IODD xml file contains invalid value
ErrorDescriptionF0000083	Error while reading text file
ErrorDescriptionF0000084	Error while writing text file
ErrorDescriptionF0000085	This file size is more than maximum limit
ErrorDescriptionF00000A0	Set fail
ErrorDescriptionF00000A1	Power cycle robot to change the firmware of the Fieldbus device, and manually enable the target Fieldbus setting again.
ErrorDescriptionF00000C0	Backup file cannot be imported. Please select another backup file
ErrorDescriptionF00000C1	The number of Backup files is limited to five. Please delete the local backup files
ErrorDescriptionF00000C2	Leasing Backup already exists. Please delete the local leasing backup
ErrorDescriptionF00000C3	The file cannot be imported. Please check that the file is authorized by TM.
ErrorDescriptionF00000E0	Invalid Command
ErrorDescriptionF00000E1	Already Login
ErrorDescriptionF00000E2	Already Logout
ErrorDescriptionF00000E3	Invalid Username Or Password
ErrorDescriptionF00000E4	File Existed
ErrorDescriptionF00000E5	Not In Auto Mode
ErrorDescriptionF00000E6	Not In Manual Mode
ErrorDescriptionF00000E7	Robot Is Running
ErrorDescriptionF00000E8	Robot is Step Run
ErrorDescriptionF00000E9	Robot control by Flow Controller
ErrorDescriptionF00000EA	Robot control by Vision Designer
ErrorDescriptionF00000EB	Speed is over limit
ErrorDescriptionF00000EC	TCP Name has existed
ErrorDescriptionF0000180	Get robot model information error.
ErrorDescriptionF0000181	The version of TMflow does not match.
ErrorDescriptionF0000182	The safety system version does not match.
ErrorDescriptionF0000183	The robot model name does not match.
ErrorDescriptionF0000184	The hardware model name does not match.

ErrorDescriptionF0000185	The robot brand name does not match.
ErrorDescriptionF0000200	Exception error
ErrorDescriptionF0000201	Command error
ErrorDescriptionF0000210	Set config fail
ErrorDescriptionF0000211	Get config fail
ErrorDescriptionF0000220	Set config fail
ErrorDescriptionF0000221	Get config fail
ErrorDescriptionF0000230	Exception error
ErrorDescriptionF0000231	Invalid parameter
ErrorDescriptionF0000232	File is not exist
ErrorDescriptionF0000233	File path is not exist
ErrorDescriptionF0000234	Set config fail
ErrorDescriptionF0000235	Get config fail
ErrorDescriptionF0000236	Get file list fail
ErrorDescriptionF0000237	Delete file fail
ErrorDescriptionF0000240	Set config fail
ErrorDescriptionF0000241	Get config fail
ErrorDescriptionF0000250	Set config fail
ErrorDescriptionF0000260	Set config fail
ErrorDescriptionF0000261	Invalid parameter
ErrorDescriptionF0000262	Get config fail
ErrorDescriptionF0000263	Delete fail
ErrorDescriptionF0000264	Invalid parameter
ErrorDescriptionF0000265	Invalid permission
ErrorDescriptionF0000266	Set config fail
ErrorDescriptionF0000267	Invalid parameter
ErrorDescriptionF0000268	Get config fail
ErrorDescriptionF0000269	Delete fail
ErrorDescriptionF000026A	Invalid parameter
ErrorDescriptionF000026B	Invalid permission
ErrorDescriptionF0000280	Set config fail
ErrorDescriptionF0000281	Get config fail
ErrorDescriptionF0000290	Set config fail
ErrorDescriptionF0000291	Get config fail
ErrorDescriptionF00002A0	Set config fail
ErrorDescriptionF00002A1	Get config fail
ErrorDescriptionF00002B0	Set config fail
ErrorDescriptionF00002B1	Get config fail
ErrorDescriptionF00002B2	Set config fail
ErrorDescriptionF00002B3	Get config fail
ErrorDescriptionF00002B4	Set config fail
ErrorDescriptionF00002B5	Get config fail
ErrorDescriptionF00002C0	Set config fail
ErrorDescriptionF00002C1	Get config fail
ErrorDescriptionF00002D0	Set config fail
ErrorDescriptionF00002D1	Get config fail
ErrorDescriptionF00002E0	Set config fail



ErrorDescriptionF00002E1	Get config fail
ErrorDescriptionF00002F0	Set config fail
ErrorDescriptionF00002F1	Get config fail
ErrorDescriptionF0000300	Set config fail
ErrorDescriptionF0000301	Get config fail
ErrorDescriptionF0000310	Set config fail
ErrorDescriptionF0000311	Get config fail
ErrorDescriptionF0000320	Set config fail
ErrorDescriptionF0000321	Get config fail
ErrorDescriptionF0000322	Get data table list fail
ErrorDescriptionF0000323	Get data table fail
ErrorDescriptionF0000324	Set data table fail
ErrorDescriptionF0000325	Delete data table fail
ErrorDescriptionF0000330	Set config fail
ErrorDescriptionF0000331	Get config fail
ErrorDescriptionF0000340	Set config fail
ErrorDescriptionF0000341	Get config fail
ErrorDescriptionF0000350	Set config fail
ErrorDescriptionF0000351	Get config fail
ErrorDescriptionF0000360	Set config fail
ErrorDescriptionF0000361	Get config fail
ErrorDescriptionF0000370	Set config fail
ErrorDescriptionF0000371	Get config fail
ErrorDescriptionF0000380	Exception error
ErrorDescriptionF0000381	Invalid parameter
ErrorDescriptionF0000382	File is not exist
ErrorDescriptionF0000383	File path is not exist
ErrorDescriptionF0000384	Set config fail
ErrorDescriptionF0000385	Get config fail
ErrorDescriptionF0000386	Get file list fail
ErrorDescriptionF0000387	Delete file fail
ErrorDescriptionF0000390	Exception error
ErrorDescriptionF0000391	Invalid parameter
ErrorDescriptionF0000392	File is not exist
ErrorDescriptionF0000393	File path is not exist
ErrorDescriptionF0000394	Set config fail
ErrorDescriptionF0000395	Get config fail
ErrorDescriptionF0000396	Get file list fail
ErrorDescriptionF0000397	Delete file fail
ErrorDescriptionF0000400	Set config fail
ErrorDescriptionF0000401	Get config fail
ErrorDescriptionF0000410	Set config fail
ErrorDescriptionF0000411	Get config fail
ErrorDescriptionF0000420	Set config fail
ErrorDescriptionF0000421	Get config fail
ErrorDescriptionF0000430	Set config fail
ErrorDescriptionF0000431	Get config fail



ErrorDescriptionF0000432	File is not exist
ErrorDescription00150000	[J1]No Error
ErrorDescription0015F051	[J1]The current in U phase of motor is too high
ErrorDescription0015F052	[J1]The current in V phase of motor is too high
ErrorDescription0015F053	[J1]The current in W phase of motor is too high
ErrorDescription0015F054	[J1]Overcurrent in DCBUS
ErrorDescription0015F055	[J1]The voltage on DCBUS is too low
ErrorDescription0015F056	[J1]The voltage on DCBUS is too high
ErrorDescription0015F057	[J1]The compensation of ADC drift is out of limit
ErrorDescription0015F058	[J1]1.65V out of limit
ErrorDescription0015F059	[J1]12V out of limit
ErrorDescription0015F05A	[J1]6V out of limit
ErrorDescription0015F05B	[J1]3.3V out of limit
ErrorDescription0015F05C	[J1]1.2V out of limit
ErrorDescription0015F05D	[J1]Power supply status error
ErrorDescription0015F061	[J1]The speed command is too large
ErrorDescription0015F062	[J1]The deviation between target and current position is too large
ErrorDescription0015F063	[J1]Motor hold protection: duty command over
ErrorDescription0015F064	[J1]Motor hold protection: current feedback over
ErrorDescription0015F071	[J1]Gate Driver diagnosis error
ErrorDescription0015F072	[J1]The temperature of PCB is too high
ErrorDescription0015F073	[J1]The acceleration of G sensor is out of range
ErrorDescription0015F074	[J1]EEPROM polling timeout
ErrorDescription0015F075	[J1]Dual encoder deviation too large
ErrorDescription0015F0A4	[J1]Flash mismatch among L0 and SL1/2
ErrorDescription0015F0A5	[J1]CM error (warning)
ErrorDescription0015F0A6	[J1]ESI and EEPROM SN mismatch (warning)
ErrorDescription0015F111	[J1]EEPROM data load fail
ErrorDescription0015F112	[J1]G sensor initialization fail
ErrorDescription0015F113	[J1]Gate driver set fail
ErrorDescription0015F114	[J1]Power supply status error
ErrorDescription0015F115	[J1]Encoder architecture mismatch
ErrorDescription0015F116	[J1]Find zone of absolute position fail
ErrorDescription0015F117	[J1]Absolute position mapping Error
ErrorDescription0015F118	[J1]Absolute position over limit at startup
ErrorDescription0015F119	[J1]The resistance of UVW of motor is abnormal
ErrorDescription0015F11A	[J1]The connection of UVW of motor is not correct
ErrorDescription0015F11B	[J1]Encoder connection failed
ErrorDescription0015F11C	[J1]Encoder diagnosis error during init process
ErrorDescription0015F121	[J1]Runin: DCBus V calibration fail
ErrorDescription0015F122	[J1]Runin: G sensor calibration process is NG
ErrorDescription0015F123	[J1]Runin: G sensor calibration result is out of limit
ErrorDescription0015F124	[J1]Runin: Encoder check fail: Z signal is abnormal
ErrorDescription0015F125	[J1]Runin: Encoder check fail: AB signal is NG
ErrorDescription0015F126	[J1]Runin: Encoder check fail: the sequence of UVW wire is reverse
ErrorDescription0015F127	[J1]Runin: Index calibration process fail
ErrorDescription0015F128	[J1]Runin: index calibration result fail

ErrorDescription0015F129	[J1]"Z search" timeout
ErrorDescription0015F12A	[J1]Runin: Multiturn calibration fail
ErrorDescription0015F12B	[J1]The parameters of joint module are abnormal
ErrorDescription0015F131	[J1]Illegal interrupt to MCU
ErrorDescription0015F132	[J1]The watchdog of MCU is timeout
ErrorDescription0015F133	[J1]S48V drop
ErrorDescription0015F134	[J1]The communication of EtherCAT is timeout
ErrorDescription0015F135	[J1]Joint movement range is NG in brake release status
ErrorDescription0015F136	[J1]Brake off current is abnormal
ErrorDescription0015F137	[J1]S48V under low lim
ErrorDescription0015F138	[J1]S48V over high lim
ErrorDescription0015F139	[J1]M48V drop
ErrorDescription0015F141	[J1]Encoder 1 diagnosis error
ErrorDescription0015F142	[J1]Encoder 2 diagnosis error
ErrorDescription0015F143	[J1]Encoder 3 diagnosis error
ErrorDescription0015F144	[J1]Encoder 4 diagnosis error
ErrorDescription0015F145	[J1]Input side Encoder miss Z signal
ErrorDescription0015F146	Input side Encoder detect multiple Z signals in single-turn
ErrorDescription0015F147	[J1]Output side Encoder miss Z signal
ErrorDescription0015F148	[J1]Output side Encoder detect multiple Z signals in single-turn
ErrorDescription0015F149	[J1]Switch target encoder fail
ErrorDescription0015F1A1	[J1]FW version doesn't match HW version
ErrorDescription0015F1A2	[J1]CM FW version doesn't match CPU1 FW version
ErrorDescription0015F1A3	[J1]Flash history record load fail
ErrorDescription0015F1A7	[J1]FW and EEPROM type mismatch
ErrorDescription0015FF20	[J1][Error][Hardware]Solenoid current is NG
ErrorDescription0015FF21	[J1][Error][Hardware]Joint movement range is NG in brake release status
ErrorDescription0015FFA0	[J1][Error][Hardware]The voltage on DCBUS is too low (40V)
ErrorDescription0015FFA1	[J1][Error][Hardware]The voltage on DCBUS is too high (60V)
ErrorDescription0015FFA2	[J1]The acceleration on X direction of G sensor is out of range
ErrorDescription0015FFA3	[J1]The acceleration on Y direction of G sensor is out of range
ErrorDescription0015FFA4	[J1]The acceleration on Z direction of G sensor is out of range
ErrorDescription0015FFA5	[J1][Error][Hardware]The temperature on PCB is too high (90 degree Celsius)
ErrorDescription0015FFA6	[J1][Error][Hardware]The current in U phase of motor is too high
ErrorDescription0015FFA7	[J1][Error][Hardware]The current in V phase of motor is too high
ErrorDescription0015FFA8	[J1][Error][Hardware]The current in W phase of motor is too high
ErrorDescription0015FFA9	[J1]The overcurrent is protected by current sensor of U phase
ErrorDescription0015FFAA	[J1]The overcurrent is protected by current sensor of V phase
ErrorDescription0015FFAB	[J1][Error][Hardware]The protection is on for motor hold
ErrorDescription0015FFAC	[J1]The initial angle of three phase of motor is not correct
ErrorDescription0015FFAD	[J1]The index angle of encoder is not calibrated
ErrorDescription0015FFAE	[J1][Error][Hardware]Overcurrent in DCBUS
ErrorDescription0015FFAF	[J1][Error][System]The communication of EtherCAT is timeout
ErrorDescription0015FFB1	[J1][Error][System]The communication of SPI is timeout
ErrorDescription0015FFB2	[J1]Illegal interrupt to MCU
ErrorDescription0015FFB3	[J1]The watchdog of MCU is timeout
ErrorDescription0015FFB4	[J1]The initialization of joint coordinate is timeout

ErrorDescription0015FFB5	[J1]FW version doesn't match HW version
ErrorDescription0015FFB6	[J1]The process in main loop is timeout
ErrorDescription0015FFB7	[J1]Brake release failed.
ErrorDescription0015FFB8	[J1][Error][Hardware]Gate Driver NG
ErrorDescription0015FFB9	[J1][Error][Hardware]MOSFET NG
ErrorDescription0015FFBA	[J1][Error][Hardware]Current Sensor NG
ErrorDescription0015FFC0	[J1]The deviation is too high when initializing joint coordinate
ErrorDescription0015FFC1	[J1]Runin process R2: Z index miss
ErrorDescription0015FFC2	[J1]Runin process R2: multi Z index happened
ErrorDescription0015FFC3	[J1]Runin process R2: U signal NG
ErrorDescription0015FFC4	[J1]Runin process R2: V signal NG
ErrorDescription0015FFC5	[J1]Runin process R2: W signal NG
ErrorDescription0015FFC6	[J1]Runin process R2: the sequence of UVW is NG
ErrorDescription0015FFC7	[J1]Runin process R2: AB signal is NG
ErrorDescription0015FFC8	[J1]Failure in loading data from EEPROM
ErrorDescription0015FFC9	[J1]The electrical angle of motor is not correct (warning)
ErrorDescription0015FFCA	[J1][Error][Hardware]Multi Z index happened in encoder output
ErrorDescription0015FFCB	[J1]The deviation between command and current position is too high
ErrorDescription0015FFCC	[J1][Error][Hardware]The Z index signal is missing
ErrorDescription0015FFCD	[J1][Error][Hardware]Encoder connection failed
ErrorDescription0015FFCE	[J1][Error][Hardware]The compensation of encoder signal is too high
ErrorDescription0015FFCF	[J1][Error][Hardware]The protection is on for motor hold (type 2)
ErrorDescription0015FFD0	[J1]The UVW signal of encoder is NG
ErrorDescription0015FFD1	[J1][Error][Hardware]The data is abnormal when reading magnetic encoder.
ErrorDescription0015FFD2	[J1][Error][Hardware]The magnet is NG judged by magnetic encoder
ErrorDescription0015FFD3	[J1][Error][Hardware]The origin of joint module is out of preset
ErrorDescription0015FFD4	[J1]The data in EEPROM is dislocated
ErrorDescription0015FFD5	[J1]The parameters for joint module are abnormal
ErrorDescription0015FFD6	[J1]The process of I2C control flow is out of control
ErrorDescription0015FFD7	[J1]Runin process R2: index calibration failed
ErrorDescription0015FFD8	[J1][Hardware][Error]The resistance of UVW of motor is abnormal
ErrorDescription0015FFD9	[J1][Hardware][Error]The connection of UVW of motor is not correct
ErrorDescription0015FFDA	[J1]Runin process R2: the current in UVW phase is NG
ErrorDescription0015FFDB	[J1]Runin process R4: UVW calibration result is out of limit
ErrorDescription0015FFDC	[J1]Runin process : G sensor calibration result is out of limit
ErrorDescription0015FFDD	[J1]a error occurs when command changes the control mode.
ErrorDescription0015FFDE	[J1]Changing EtherCAT ESM when PDS is in OP mode
ErrorDescription0015FFDF	[J1]Unknown EtherCAT ESM command
ErrorDescription0015FFE0	[J1][Hardware][Error]The voltage of DC bus is low in EtherCAT OP mode
ErrorDescription0015FFE1	[J1]Online multiturn calibration failed
ErrorDescription0015FFE2	[J1]The magnetic encoder data is not stable in the position initialization process
ErrorDescription0015FFE3	[J1]The joint angle between "power on" and "position initialization" exceeds limit
ErrorDescription0015FFE4	[J1][Error][System]The position initialization process is timeout ("Z search" is not finished)
ErrorDescription0015FFE5	[J1]The position initialization process is timeout
ErrorDescription0015FFE6	[J1]The result is NG in position initialization process
ErrorDescription0015FFE7	[J1]Runin process: the process of g sensor calibration is NG
ErrorDescription0015FFE8	[J1][Hardware][Error]The output of g sensor is NG

ErrorDescription0015FFE9	[J1]The check sum result from EEPROM data is abnormal
ErrorDescription0015FFEA	[J1][Hardware][Error]The voltage of 5V is NG
ErrorDescription0015FFEB	[J1][Hardware][Error]The voltage of 12V is NG
ErrorDescription0015FFEC	[J1]The ADC compensation is out of limit
ErrorDescription0015FFED	[J1][Error][Hardware]The compensation of encoder signal is too high in ABS mode
ErrorDescription0015FFEE	[J1]The deviation is too high between latching index and position initialization process
ErrorDescription0015FFEF	[J1]The parameters of magnetic encoder are abnormal
ErrorDescription00250000	[J2]No Error
ErrorDescription0025F051	[J2]The current in U phase of motor is too high
ErrorDescription0025F052	[J2]The current in V phase of motor is too high
ErrorDescription0025F053	[J2]The current in W phase of motor is too high
ErrorDescription0025F054	[J2]Overcurrent in DCBUS
ErrorDescription0025F055	[J2]The voltage on DCBUS is too low
ErrorDescription0025F056	[J2]The voltage on DCBUS is too high
ErrorDescription0025F057	[J2]The compensation of ADC drift is out of limit
ErrorDescription0025F058	[J2]1.65V out of limit
ErrorDescription0025F059	[J2]12V out of limit
ErrorDescription0025F05A	[J2]6V out of limit
ErrorDescription0025F05B	[J2]3.3V out of limit
ErrorDescription0025F05C	[J2]1.2V out of limit
ErrorDescription0025F05D	[J2]Power supply status error
ErrorDescription0025F061	[J2]The speed command is too large
ErrorDescription0025F062	[J2]The deviation between target and current position is too large
ErrorDescription0025F063	[J2]Motor hold protection: duty command over
ErrorDescription0025F064	[J2]Motor hold protection: current feedback over
ErrorDescription0025F071	[J2]Gate Driver diagnosis error
ErrorDescription0025F072	[J2]The temperature of PCB is too high
ErrorDescription0025F073	[J2]The acceleration of G sensor is out of range
ErrorDescription0025F074	[J2]EEPROM polling timeout
ErrorDescription0025F075	[J2]Dual encoder deviation too large
ErrorDescription0025F0A4	[J2]Flash mismatch among L0 and SL1/2
ErrorDescription0025F0A5	[J2]CM error (warning)
ErrorDescription0025F0A6	[J2]ESI and EEPROM SN mismatch (warning)
ErrorDescription0025F111	[J2]EEPROM data load fail
ErrorDescription0025F112	[J2]G sensor initialization fail
ErrorDescription0025F113	[J2]Gate driver set fail
ErrorDescription0025F114	[J2]Power supply status error
ErrorDescription0025F115	[J2]Encoder architecture mismatch
ErrorDescription0025F116	[J2]Find zone of absolute position fail
ErrorDescription0025F117	[J2]Absolute position mapping Error
ErrorDescription0025F118	[J2]Absolute position over limit at startup
ErrorDescription0025F119	[J2]The resistance of UVW of motor is abnormal
ErrorDescription0025F11A	[J2]The connection of UVW of motor is not correct
ErrorDescription0025F11B	[J2]Encoder connection failed
ErrorDescription0025F11C	[J2]Encoder diagnosis error during init process
ErrorDescription0025F121	[J2]Runin: DCBus V calibration fail
ErrorDescription0025F122	[J2]Runin: G sensor calibration process is NG

ErrorDescription0025F123	[J2]Runin: G sensor calibration result is out of limit
ErrorDescription0025F124	[J2]Runin: Encoder check fail: Z signal is abnormal
ErrorDescription0025F125	[J2]Runin: Encoder check fail: AB signal is NG
ErrorDescription0025F126	[J2]Runin: Encoder check fail: the sequence of UVW wire is reverse
ErrorDescription0025F127	[J2]Runin: Index calibration process fail
ErrorDescription0025F128	[J2]Runin: index calibration result fail
ErrorDescription0025F129	[J2]"Z search" timeout
ErrorDescription0025F12A	[J2]Runin: Multiturn calibration fail
ErrorDescription0025F12B	[J2]The parameters of joint module are abnormal
ErrorDescription0025F131	[J2]Illegal interrupt to MCU
ErrorDescription0025F132	[J2]The watchdog of MCU is timeout
ErrorDescription0025F133	[J2]S48V drop
ErrorDescription0025F134	[J2]The communication of EtherCAT is timeout
ErrorDescription0025F135	[J2]Joint movement range is NG in brake release status
ErrorDescription0025F136	[J2]Brake off current is abnormal
ErrorDescription0025F137	[J2]S48V under low lim
ErrorDescription0025F138	[J2]S48V over high lim
ErrorDescription0025F139	[J2]M48V drop
ErrorDescription0025F141	[J2]Encoder 1 diagnosis error
ErrorDescription0025F142	[J2]Encoder 2 diagnosis error
ErrorDescription0025F143	[J2]Encoder 3 diagnosis error
ErrorDescription0025F144	[J2]Encoder 4 diagnosis error
ErrorDescription0025F145	[J2]Input side Encoder miss Z signal
ErrorDescription0025F146	[J2]Input side Encoder detect multiple Z signals in single-turn
ErrorDescription0025F147	[J2]Output side Encoder miss Z signal
ErrorDescription0025F148	[J2]Output side Encoder detect multiple Z signals in single-turn
ErrorDescription0025F149	[J2]Switch target encoder fail
ErrorDescription0025F1A1	[J2]FW version doesn't match HW version
ErrorDescription0025F1A2	[J2]CM FW version doesn't match CPU1 FW version
ErrorDescription0025F1A3	[J2]Flash history record load fail
ErrorDescription0025F1A7	[J2]FW and EEPROM type mismatch
ErrorDescription0025FF20	[J2][Error][Hardware]Solenoid current is NG
ErrorDescription0025FF21	[J2][Error][Hardware]Joint movement range is NG in brake release status
ErrorDescription0025FFA0	[J2][Error][Hardware]The voltage on DCBUS is too low (40V)
ErrorDescription0025FFA1	[J2][Error][Hardware]The voltage on DCBUS is too high (60V)
ErrorDescription0025FFA2	[J2]The acceleration on X direction of G sensor is out of range
ErrorDescription0025FFA3	[J2]The acceleration on Y direction of G sensor is out of range
ErrorDescription0025FFA4	[J2]The acceleration on Z direction of G sensor is out of range
ErrorDescription0025FFA5	[J2][Error][Hardware]The temperature on PCB is too high (90 degree Celsius)
ErrorDescription0025FFA6	[J2][Error][Hardware]The current in U phase of motor is too high
ErrorDescription0025FFA7	[J2][Error][Hardware]The current in V phase of motor is too high
ErrorDescription0025FFA8	[J2][Error][Hardware]The current in W phase of motor is too high
ErrorDescription0025FFA9	[J2]The overcurrent is protected by current sensor of U phase
ErrorDescription0025FFAA	[J2]The overcurrent is protected by current sensor of V phase
ErrorDescription0025FFAB	[J2][Error][Hardware]The protection is on for motor hold
ErrorDescription0025FFAC	[J2]The initial angle of three phase of motor is not correct
ErrorDescription0025FFAD	[J2]The index angle of encoder is not calibrated

ErrorDescription0025FFAE	[J2][Error][Hardware]Overcurrent in DCBUS
ErrorDescription0025FFAF	[J2][Error][System]The communication of EtherCAT is timeout
ErrorDescription0025FFB1	[J2][Error][System]The communication of SPI is timeout
ErrorDescription0025FFB2	[J2]Illegal interrupt to MCU
ErrorDescription0025FFB3	[J2]The watchdog of MCU is timeout
ErrorDescription0025FFB4	[J2]The initialization of joint coordinate is timeout
ErrorDescription0025FFB5	[J2]FW version doesn't match HW version
ErrorDescription0025FFB6	[J2]The process in main loop is timeout
ErrorDescription0025FFB7	[J2]Brake release failed.
ErrorDescription0025FFB8	[J2][Error][Hardware]Gate Driver NG
ErrorDescription0025FFB9	[J2][Error][Hardware]MOSFET NG
ErrorDescription0025FFBA	[J2][Error][Hardware]Current Sensor NG
ErrorDescription0025FFC0	[J2]The deviation is too high when initializing joint coordinate
ErrorDescription0025FFC1	[J2]Runin process R2: Z index miss
ErrorDescription0025FFC2	[J2]Runin process R2: multi Z index happened
ErrorDescription0025FFC3	[J2]Runin process R2: U signal NG
ErrorDescription0025FFC4	[J2]Runin process R2: V signal NG
ErrorDescription0025FFC5	[J2]Runin process R2: W signal NG
ErrorDescription0025FFC6	[J2]Runin process R2: the sequence of UVW is NG
ErrorDescription0025FFC7	[J2]Runin process R2: AB signal is NG
ErrorDescription0025FFC8	[J2]Failure in loading data from EEPROM
ErrorDescription0025FFC9	[J2]The electrical angle of motor is not correct (warning)
ErrorDescription0025FFCA	[J2][Error][Hardware]Multi Z index happened in encoder output
ErrorDescription0025FFCB	[J2]The deviation between command and current position is too high
ErrorDescription0025FFCC	[J2][Error][Hardware]The Z index signal is missing
ErrorDescription0025FFCD	[J2][Error][Hardware]Encoder connection failed
ErrorDescription0025FFCE	[J2][Error][Hardware]The compensation of encoder signal is too high
ErrorDescription0025FFCF	[J2][Error][Hardware]The protection is on for motor hold (type 2)
ErrorDescription0025FFD0	[J2]The UVW signal of encoder is NG
ErrorDescription0025FFD1	[J2][Error][Hardware]The data is abnormal when reading magnetic encoder.
ErrorDescription0025FFD2	[J2][Error][Hardware]The magnet is NG judged by magnetic encoder
ErrorDescription0025FFD3	[J2][Error][Hardware]The origin of joint module is out of preset
ErrorDescription0025FFD4	[J2]The data in EEPROM is dislocated
ErrorDescription0025FFD5	[J2]The parameters for joint module are abnormal
ErrorDescription0025FFD6	[J2]The process of I2C control flow is out of control
ErrorDescription0025FFD7	[J2]Runin process R2: index calibration failed
ErrorDescription0025FFD8	[J2][Hardware][Error]The resistance of UVW of motor is abnormal
ErrorDescription0025FFD9	[J2][Hardware][Error]The connection of UVW of motor is not correct
ErrorDescription0025FFDA	[J2]Runin process R2: the current in UVW phase is NG
ErrorDescription0025FFDB	[J2]Runin process R4: UVW calibration result is out of limit
ErrorDescription0025FFDC	[J2]Runin process : G sensor calibration result is out of limit
ErrorDescription0025FFDD	[J2]a error occurs when command changes the control mode.
ErrorDescription0025FFDE	[J2]Changing EtherCAT ESM when PDS is in OP mode
ErrorDescription0025FFDF	[J2]Unknown EtherCAT ESM command
ErrorDescription0025FFE0	[J2][Hardware][Error]The voltage of DC bus is low in EtherCAT OP mode
ErrorDescription0025FFE1	[J2]Online multiturn calibration failed
ErrorDescription0025FFE2	[J2]The magnetic encoder data is not stable in the position initialization process



ErrorDescription0025FFE3	[J2]The joint angle between "power on" and "position initialization" exceeds limit
ErrorDescription0025FFE4	[J2][Error][System]The position initialization process is timeout ("Z search" is not finished)
ErrorDescription0025FFE5	[J2]The position initialization process is timeout
ErrorDescription0025FFE6	[J2]The result is NG in position initialization process
ErrorDescription0025FFE7	[J2]Runin process: the process of g sensor calibration is NG
ErrorDescription0025FFE8	[J2][Hardware][Error]The output of g sensor is NG
ErrorDescription0025FFE9	[J2]The check sum result from EEPROM data is abnormal
ErrorDescription0025FFEA	[J2][Hardware][Error]The voltage of 5V is NG
ErrorDescription0025FFEB	[J2][Hardware][Error]The voltage of 12V is NG
ErrorDescription0025FFEC	[J2]The ADC compensation is out of limit
ErrorDescription0025FFED	[J2][Error][Hardware]The compensation of encoder signal is too high in ABS mode
ErrorDescription0025FFEE	[J2]The deviation is too high between latching index and position initialization process
ErrorDescription0025FFEF	[J2]The parameters of magnetic encoder are abnormal
ErrorDescription00350000	[J3]No Error
ErrorDescription0035F051	[J3]The current in U phase of motor is too high
ErrorDescription0035F052	[J3]The current in V phase of motor is too high
ErrorDescription0035F053	[J3]The current in W phase of motor is too high
ErrorDescription0035F054	[J3]Overcurrent in DCBUS
ErrorDescription0035F055	[J3]The voltage on DCBUS is too low
ErrorDescription0035F056	[J3]The voltage on DCBUS is too high
ErrorDescription0035F057	[J3]The compensation of ADC drift is out of limit
ErrorDescription0035F058	[J3]1.65V out of limit
ErrorDescription0035F059	[J3]12V out of limit
ErrorDescription0035F05A	[J3]6V out of limit
ErrorDescription0035F05B	[J3]3.3V out of limit
ErrorDescription0035F05C	[J3]1.2V out of limit
ErrorDescription0035F05D	[J3]Power supply status error
ErrorDescription0035F061	[J3]The speed command is too large
ErrorDescription0035F062	[J3]The deviation between target and current position is too large
ErrorDescription0035F063	[J3]Motor hold protection: duty command over
ErrorDescription0035F064	[J3]Motor hold protection: current feedback over
ErrorDescription0035F071	[J3]Gate Driver diagnosis error
ErrorDescription0035F072	[J3]The temperature of PCB is too high
ErrorDescription0035F073	[J3]The acceleration of G sensor is out of range
ErrorDescription0035F074	[J3]EEPROM polling timeout
ErrorDescription0035F075	[J3]Dual encoder deviation too large
ErrorDescription0035F0A4	[J3]Flash mismatch among L0 and SL1/2
ErrorDescription0035F0A5	[J3]CM error (warning)
ErrorDescription0035F0A6	[J3]ESI and EEPROM SN mismatch (warning)
ErrorDescription0035F111	[J3]EEPROM data load fail
ErrorDescription0035F112	[J3]G sensor initialization fail
ErrorDescription0035F113	[J3]Gate driver set fail
ErrorDescription0035F114	[J3]Power supply status error
ErrorDescription0035F115	[J3]Encoder architecture mismatch
ErrorDescription0035F116	[J3]Find zone of absolute position fail
ErrorDescription0035F117	[J3]Absolute position mapping Error
ErrorDescription0035F118	[J3]Absolute position over limit at startup

ErrorDescription0035F119	[J3]The resistance of UVW of motor is abnormal
ErrorDescription0035F11A	[J3]The connection of UVW of motor is not correct
ErrorDescription0035F11B	[J3]Encoder connection failed
ErrorDescription0035F11C	[J3]Encoder diagnosis error during init process
ErrorDescription0035F121	[J3]Runin: DCBus V calibration fail
ErrorDescription0035F122	[J3]Runin: G sensor calibration process is NG
ErrorDescription0035F123	[J3]Runin: G sensor calibration result is out of limit
ErrorDescription0035F124	[J3]Runin: Encoder check fail: Z signal is abnormal
ErrorDescription0035F125	[J3]Runin: Encoder check fail: AB signal is NG
ErrorDescription0035F126	[J3]Runin: Encoder check fail: the sequence of UVW wire is reverse
ErrorDescription0035F127	[J3]Runin: Index calibration process fail
ErrorDescription0035F128	[J3]Runin: index calibration result fail
ErrorDescription0035F129	[J3]"Z search" timeout
ErrorDescription0035F12A	[J3]Runin: Multiturn calibration fail
ErrorDescription0035F12B	[J3]The parameters of joint module are abnormal
ErrorDescription0035F131	[J3]Illegal interrupt to MCU
ErrorDescription0035F132	[J3]The watchdog of MCU is timeout
ErrorDescription0035F133	[J3]S48V drop
ErrorDescription0035F134	[J3]The communication of EtherCAT is timeout
ErrorDescription0035F135	[J3]Joint movement range is NG in brake release status
ErrorDescription0035F136	[J3]Brake off current is abnormal
ErrorDescription0035F137	[J3]S48V under low lim
ErrorDescription0035F138	[J3]S48V over high lim
ErrorDescription0035F139	[J3]M48V drop
ErrorDescription0035F141	[J3]Encoder 1 diagnosis error
ErrorDescription0035F142	[J3]Encoder 2 diagnosis error
ErrorDescription0035F143	[J3]Encoder 3 diagnosis error
ErrorDescription0035F144	[J3]Encoder 4 diagnosis error
ErrorDescription0035F145	[J3]Input side Encoder miss Z signal
ErrorDescription0035F146	[J3]Input side Encoder detect multiple Z signals in single-turn
ErrorDescription0035F147	[J3]Output side Encoder miss Z signal
ErrorDescription0035F148	[J3]Output side Encoder detect multiple Z signals in single-turn
ErrorDescription0035F149	[J3]Switch target encoder fail
ErrorDescription0035F1A1	[J3]FW version doesn't match HW version
ErrorDescription0035F1A2	[J3]CM FW version doesn't match CPU1 FW version
ErrorDescription0035F1A3	[J3]Flash history record load fail
ErrorDescription0035F1A7	[J3]FW and EEPROM type mismatch
ErrorDescription0035FF20	[J3][Error][Hardware]Solenoid current is NG
ErrorDescription0035FF21	[J3][Error][Hardware]Joint movement range is NG in brake release status
ErrorDescription0035FFA0	[J3][Error][Hardware]The voltage on DCBUS is too low (40V)
ErrorDescription0035FFA1	[J3][Error][Hardware]The voltage on DCBUS is too high (60V)
ErrorDescription0035FFA2	[J3]The acceleration on X direction of G sensor is out of range
ErrorDescription0035FFA3	[J3]The acceleration on Y direction of G sensor is out of range
ErrorDescription0035FFA4	[J3]The acceleration on Z direction of G sensor is out of range
ErrorDescription0035FFA5	[J3][Error][Hardware]The temperature on PCB is too high (90 degree Celsius)
ErrorDescription0035FFA6	[J3][Error][Hardware]The current in U phase of motor is too high
ErrorDescription0035FFA7	[J3][Error][Hardware]The current in V phase of motor is too high



ErrorDescription0035FFA8	[J3][Error][Hardware]The current in W phase of motor is too high
ErrorDescription0035FFA9	[J3]The overcurrent is protected by current sensor of U phase
ErrorDescription0035FFAA	[J3]The overcurrent is protected by current sensor of V phase
ErrorDescription0035FFAB	[J3][Error][Hardware]The protection is on for motor hold
ErrorDescription0035FFAC	[J3]The initial angle of three phase of motor is not correct
ErrorDescription0035FFAD	[J3]The index angle of encoder is not calibrated
ErrorDescription0035FFAE	[J3][Error][Hardware]Overcurrent in DCBUS
ErrorDescription0035FFAF	[J3][Error][System]The communication of EtherCAT is timeout
ErrorDescription0035FFB1	[J3][Error][System]The communication of SPI is timeout
ErrorDescription0035FFB2	[J3]Illegal interrupt to MCU
ErrorDescription0035FFB3	[J3]The watchdog of MCU is timeout
ErrorDescription0035FFB4	[J3]The initialization of joint coordinate is timeout
ErrorDescription0035FFB5	[J3]FW version doesn't match HW version
ErrorDescription0035FFB6	[J3]The process in main loop is timeout
ErrorDescription0035FFB7	[J3]Brake release failed.
ErrorDescription0035FFB8	[J3][Error][Hardware]Gate Driver NG
ErrorDescription0035FFB9	[J3][Error][Hardware]MOSFET NG
ErrorDescription0035FFBA	[J3][Error][Hardware]Current Sensor NG
ErrorDescription0035FFC0	[J3]The deviation is too high when initializing joint coordinate
ErrorDescription0035FFC1	[J3]Runin process R2: Z index miss
ErrorDescription0035FFC2	[J3]Runin process R2: multi Z index happened
ErrorDescription0035FFC3	[J3]Runin process R2: U signal NG
ErrorDescription0035FFC4	[J3]Runin process R2: V signal NG
ErrorDescription0035FFC5	[J3]Runin process R2: W signal NG
ErrorDescription0035FFC6	[J3]Runin process R2: the sequence of UVW is NG
ErrorDescription0035FFC7	[J3]Runin process R2: AB signal is NG
ErrorDescription0035FFC8	[J3]Failure in loading data from EEPROM
ErrorDescription0035FFC9	[J3]The electrical angle of motor is not correct (warning)
ErrorDescription0035FFCA	[J3][Error][Hardware]Multi Z index happened in encoder output
ErrorDescription0035FFCB	[J3]The deviation between command and current position is too high
ErrorDescription0035FFCC	[J3][Error][Hardware]The Z index signal is missing
ErrorDescription0035FFCD	[J3][Error][Hardware]Encoder connection failed
ErrorDescription0035FFCE	[J3][Error][Hardware]The compensation of encoder signal is too high
ErrorDescription0035FFCF	[J3][Error][Hardware]The protection is on for motor hold (type 2)
ErrorDescription0035FFD0	[J3]The UVW signal of encoder is NG
ErrorDescription0035FFD1	[J3][Error][Hardware]The data is abnormal when reading magnetic encoder.
ErrorDescription0035FFD2	[J3][Error][Hardware]The magnet is NG judged by magnetic encoder
ErrorDescription0035FFD3	[J3][Error][Hardware]The origin of joint module is out of preset
ErrorDescription0035FFD4	[J3]The data in EEPROM is dislocated
ErrorDescription0035FFD5	[J3]The parameters for joint module are abnormal
ErrorDescription0035FFD6	[J3]The process of I2C control flow is out of control
ErrorDescription0035FFD7	[J3]Runin process R2: index calibration failed
ErrorDescription0035FFD8	[J3][Hardware][Error]The resistance of UVW of motor is abnormal
ErrorDescription0035FFD9	[J3][Hardware][Error]The connection of UVW of motor is not correct
ErrorDescription0035FFDA	[J3]Runin process R2: the current in UVW phase is NG
ErrorDescription0035FFDB	[J3]Runin process R4: UVW calibration result is out of limit
ErrorDescription0035FFDC	[J3]Runin process : G sensor calibration result is out of limit

ErrorDescription0035FFDD	[J3]a error occurs when command changes the control mode.
ErrorDescription0035FFDE	[J3]Changing EtherCAT ESM when PDS is in OP mode
ErrorDescription0035FFDF	[J3]Unknown EtherCAT ESM command
ErrorDescription0035FFE0	[J3][Hardware][Error]The voltage of DC bus is low in EtherCAT OP mode
ErrorDescription0035FFE1	[J3]Online multiturn calibration failed
ErrorDescription0035FFE2	[J3]The magnetic encoder data is not stable in the position initialization process
ErrorDescription0035FFE3	[J3]The joint angle between "power on" and "position initialization" exceeds limit
ErrorDescription0035FFE4	[J3][Error][System]The position initialization process is timeout ("Z search" is not finished)
ErrorDescription0035FFE5	[J3]The position initialization process is timeout
ErrorDescription0035FFE6	[J3]The result is NG in position initialization process
ErrorDescription0035FFE7	[J3]Runin process: the process of g sensor calibration is NG
ErrorDescription0035FFE8	[J3][Hardware][Error]The output of g sensor is NG
ErrorDescription0035FFE9	[J3]The check sum result from EEPROM data is abnormal
ErrorDescription0035FFEA	[J3][Hardware][Error]The voltage of 5V is NG
ErrorDescription0035FFEB	[J3][Hardware][Error]The voltage of 12V is NG
ErrorDescription0035FFEC	[J3]The ADC compensation is out of limit
ErrorDescription0035FFED	[J3][Error][Hardware]The compensation of encoder signal is too high in ABS mode
ErrorDescription0035FFEE	[J3]The deviation is too high between latching index and position initialization process
ErrorDescription0035FFEF	[J3]The parameters of magnetic encoder are abnormal
ErrorDescription00450000	[J4]No Error
ErrorDescription0045F051	[J4]The current in U phase of motor is too high
ErrorDescription0045F052	[J4]The current in V phase of motor is too high
ErrorDescription0045F053	[J4]The current in W phase of motor is too high
ErrorDescription0045F054	[J4]Overcurrent in DCBUS
ErrorDescription0045F055	[J4]The voltage on DCBUS is too low
ErrorDescription0045F056	[J4]The voltage on DCBUS is too high
ErrorDescription0045F057	[J4]The compensation of ADC drift is out of limit
ErrorDescription0045F058	[J4]1.65V out of limit
ErrorDescription0045F059	[J4]12V out of limit
ErrorDescription0045F05A	[J4]6V out of limit
ErrorDescription0045F05B	[J4]3.3V out of limit
ErrorDescription0045F05C	[J4]1.2V out of limit
ErrorDescription0045F05D	[J4]Power supply status error
ErrorDescription0045F061	[J4]The speed command is too large
ErrorDescription0045F062	[J4]The deviation between target and current position is too large
ErrorDescription0045F063	[J4]Motor hold protection: duty command over
ErrorDescription0045F064	[J4]Motor hold protection: current feedback over
ErrorDescription0045F071	[J4]Gate Driver diagnosis error
ErrorDescription0045F072	[J4]The temperature of PCB is too high
ErrorDescription0045F073	[J4]The acceleration of G sensor is out of range
ErrorDescription0045F074	[J4]EEPROM polling timeout
ErrorDescription0045F075	[J4]Dual encoder deviation too large
ErrorDescription0045F0A4	[J4]Flash mismatch among L0 and SL1/2
ErrorDescription0045F0A5	[J4]CM error (warning)
ErrorDescription0045F0A6	[J4]ESI and EEPROM SN mismatch (warning)
ErrorDescription0045F111	[J4]EEPROM data load fail
ErrorDescription0045F112	[J4]G sensor initialization fail

ErrorDescription0045F113	[J4]Gate driver set fail
ErrorDescription0045F114	[J4]Power supply status error
ErrorDescription0045F115	[J4]Encoder architecture mismatch
ErrorDescription0045F116	[J4]Find zone of absolute position fail
ErrorDescription0045F117	[J4]Absolute position mapping Error
ErrorDescription0045F118	[J4]Absolute position over limit at startup
ErrorDescription0045F119	[J4]The resistance of UVW of motor is abnormal
ErrorDescription0045F11A	[J4]The connection of UVW of motor is not correct
ErrorDescription0045F11B	[J4]Encoder connection failed
ErrorDescription0045F11C	[J4]Encoder diagnosis error during init process
ErrorDescription0045F121	[J4]Runin: DCBus V calibration fail
ErrorDescription0045F122	[J4]Runin: G sensor calibration process is NG
ErrorDescription0045F123	[J4]Runin: G sensor calibration result is out of limit
ErrorDescription0045F124	[J4]Runin: Encoder check fail: Z signal is abnormal
ErrorDescription0045F125	[J4]Runin: Encoder check fail: AB signal is NG
ErrorDescription0045F126	[J4]Runin: Encoder check fail: the sequence of UVW wire is reverse
ErrorDescription0045F127	[J4]Runin: Index calibration process fail
ErrorDescription0045F128	[J4]Runin: index calibration result fail
ErrorDescription0045F129	[J4]"Z search" timeout
ErrorDescription0045F12A	[J4]Runin: Multiturn calibration fail
ErrorDescription0045F12B	[J4]The parameters of joint module are abnormal
ErrorDescription0045F131	[J4]Illegal interrupt to MCU
ErrorDescription0045F132	[J4]The watchdog of MCU is timeout
ErrorDescription0045F133	[J4]S48V drop
ErrorDescription0045F134	[J4]The communication of EtherCAT is timeout
ErrorDescription0045F135	[J4]Joint movement range is NG in brake release status
ErrorDescription0045F136	[J4]Brake off current is abnormal
ErrorDescription0045F137	[J4]S48V under low lim
ErrorDescription0045F138	[J4]S48V over high lim
ErrorDescription0045F139	[J4]M48V drop
ErrorDescription0045F141	[J4]Encoder 1 diagnosis error
ErrorDescription0045F142	[J4]Encoder 2 diagnosis error
ErrorDescription0045F143	[J4]Encoder 3 diagnosis error
ErrorDescription0045F144	[J4]Encoder 4 diagnosis error
ErrorDescription0045F145	[J4]Input side Encoder miss Z signal
ErrorDescription0045F146	[J4]Input side Encoder detect multiple Z signals in single-turn
ErrorDescription0045F147	[J4]Output side Encoder miss Z signal
ErrorDescription0045F148	[J4]Output side Encoder detect multiple Z signal in single-turn
ErrorDescription0045F149	[J4]Switch target encoder fail
ErrorDescription0045F1A1	[J4]FW version doesn't match HW version
ErrorDescription0045F1A2	[J4]CM FW version doesn't match CPU1 FW version
ErrorDescription0045F1A3	[J4]Flash history record load fail
ErrorDescription0045F1A7	[J4]FW and EEPROM type mismatch
ErrorDescription0045FF20	[J4][Error][Hardware]Solenoid current is NG
ErrorDescription0045FF21	[J4][Error][Hardware]Joint movement range is NG in brake release status
ErrorDescription0045FFA0	[J4][Error][Hardware]The voltage on DCBUS is too low (40V)
ErrorDescription0045FFA1	[J4][Error][Hardware]The voltage on DCBUS is too high (60V)

ErrorDescription0045FFA2	[J4]The acceleration on X direction of G sensor is out of range
ErrorDescription0045FFA3	[J4]The acceleration on Y direction of G sensor is out of range
ErrorDescription0045FFA4	[J4]The acceleration on Z direction of G sensor is out of range
ErrorDescription0045FFA5	[J4][Error][Hardware]The temperature on PCB is too high (90 degree Celsius)
ErrorDescription0045FFA6	[J4][Error][Hardware]The current in U phase of motor is too high
ErrorDescription0045FFA7	[J4][Error][Hardware]The current in V phase of motor is too high
ErrorDescription0045FFA8	[J4][Error][Hardware]The current in W phase of motor is too high
ErrorDescription0045FFA9	[J4]The overcurrent is protected by current sensor of U phase
ErrorDescription0045FFAA	[J4]The overcurrent is protected by current sensor of V phase
ErrorDescription0045FFAB	[J4][Error][Hardware]The protection is on for motor hold
ErrorDescription0045FFAC	[J4]The initial angle of three phase of motor is not correct
ErrorDescription0045FFAD	[J4]The index angle of encoder is not calibrated
ErrorDescription0045FFAE	[J4][Error][Hardware]Overcurrent in DCBUS
ErrorDescription0045FFAF	[J4][Error][System]The communication of EtherCAT is timeout
ErrorDescription0045FFB1	[J4][Error][System]The communication of SPI is timeout
ErrorDescription0045FFB2	[J4]Illegal interrupt to MCU
ErrorDescription0045FFB3	[J4]The watchdog of MCU is timeout
ErrorDescription0045FFB4	[J4]The initialization of joint coordinate is timeout
ErrorDescription0045FFB5	[J4]FW version doesn't match HW version
ErrorDescription0045FFB6	[J4]The process in main loop is timeout
ErrorDescription0045FFB7	[J4]Brake release failed.
ErrorDescription0045FFB8	[J4][Error][Hardware]Gate Driver NG
ErrorDescription0045FFB9	[J4][Error][Hardware]MOSFET NG
ErrorDescription0045FFBA	[J4][Error][Hardware]Current Sensor NG
ErrorDescription0045FFC0	[J4]The deviation is too high when initializing joint coordinate
ErrorDescription0045FFC1	[J4]Runin process R2: Z index miss
ErrorDescription0045FFC2	[J4]Runin process R2: multi Z index happened
ErrorDescription0045FFC3	[J4]Runin process R2: U signal NG
ErrorDescription0045FFC4	[J4]Runin process R2: V signal NG
ErrorDescription0045FFC5	[J4]Runin process R2: W signal NG
ErrorDescription0045FFC6	[J4]Runin process R2: the sequence of UVW is NG
ErrorDescription0045FFC7	[J4]Runin process R2: AB signal is NG
ErrorDescription0045FFC8	[J4]Failure in loading data from EEPROM
ErrorDescription0045FFC9	[J4]The electrical angle of motor is not correct (warning)
ErrorDescription0045FFCA	[J4][Error][Hardware]Multi Z index happened in encoder output
ErrorDescription0045FFCB	[J4]The deviation between command and current position is too high
ErrorDescription0045FFCC	[J4][Error][Hardware]The Z index signal is missing
ErrorDescription0045FFCD	[J4][Error][Hardware]Encoder connection failed
ErrorDescription0045FFCE	[J4][Error][Hardware]The compensation of encoder signal is too high
ErrorDescription0045FFCF	[J4][Error][Hardware]The protection is on for motor hold (type 2)
ErrorDescription0045FFD0	[J4]The UVW signal of encoder is NG
ErrorDescription0045FFD1	[J4][Error][Hardware]The data is abnormal when reading magnetic encoder.
ErrorDescription0045FFD2	[J4][Error][Hardware]The magnet is NG judged by magnetic encoder
ErrorDescription0045FFD3	[J4][Error][Hardware]The origin of joint module is out of preset
ErrorDescription0045FFD4	[J4]The data in EEPROM is dislocated
ErrorDescription0045FFD5	[J4]The parameters for joint module are abnormal
ErrorDescription0045FFD6	[J4]The process of I2C control flow is out of control

ErrorDescription0045FFD7	[J4]Runin process R2: index calibration failed
ErrorDescription0045FFD8	[J4][Hardware][Error]The resistance of UVW of motor is abnormal
ErrorDescription0045FFD9	[J4][Hardware][Error]The connection of UVW of motor is not correct
ErrorDescription0045FFDA	[J4]Runin process R2: the current in UVW phase is NG
ErrorDescription0045FFDB	[J4]Runin process R4: UVW calibration result is out of limit
ErrorDescription0045FFDC	[J4]Runin process : G sensor calibration result is out of limit
ErrorDescription0045FFDD	[J4]a error occurs when command changes the control mode.
ErrorDescription0045FFDE	[J4]Changing EtherCAT ESM when PDS is in OP mode
ErrorDescription0045FFDF	[J4]Unknown EtherCAT ESM command
ErrorDescription0045FFE0	[J4][Hardware][Error]The voltage of DC bus is low in EtherCAT OP mode
ErrorDescription0045FFE1	[J4]Online multiturn calibration failed
ErrorDescription0045FFE2	[J4]The magnetic encoder data is not stable in the position initialization process
ErrorDescription0045FFE3	[J4]The joint angle between "power on" and "position initialization" exceeds limit
ErrorDescription0045FFE4	[J4][Error][System]The position initialization process is timeout ("Z search" is not finished)
ErrorDescription0045FFE5	[J4]The position initialization process is timeout
ErrorDescription0045FFE6	[J4]The result is NG in position initialization process
ErrorDescription0045FFE7	[J4]Runin process: the process of g sensor calibration is NG
ErrorDescription0045FFE8	[J4][Hardware][Error]The output of g sensor is NG
ErrorDescription0045FFE9	[J4]The check sum result from EEPROM data is abnormal
ErrorDescription0045FFEA	[J4][Hardware][Error]The voltage of 5V is NG
ErrorDescription0045FFEB	[J4][Hardware][Error]The voltage of 12V is NG
ErrorDescription0045FFEC	[J4]The ADC compensation is out of limit
ErrorDescription0045FFED	[J4][Error][Hardware]The compensation of encoder signal is too high in ABS mode
ErrorDescription0045FFEE	[J4]The deviation is too high between latching index and position initialization process
ErrorDescription0045FFEF	[J4]The parameters of magnetic encoder are abnormal
ErrorDescription00550000	[J5]No Error
ErrorDescription0055F051	[J5]The current in U phase of motor is too high
ErrorDescription0055F052	[J5]The current in V phase of motor is too high
ErrorDescription0055F053	[J5]The current in W phase of motor is too high
ErrorDescription0055F054	[J5]Overcurrent in DCBUS
ErrorDescription0055F055	[J5]The voltage on DCBUS is too low
ErrorDescription0055F056	[J5]The voltage on DCBUS is too high
ErrorDescription0055F057	[J5]The compensation of ADC drift is out of limit
ErrorDescription0055F058	[J5]1.65V out of limit
ErrorDescription0055F059	[J5]12V out of limit
ErrorDescription0055F05A	[J5]6V out of limit
ErrorDescription0055F05B	[J5]3.3V out of limit
ErrorDescription0055F05C	[J5]1.2V out of limit
ErrorDescription0055F05D	[J5]Power supply status error
ErrorDescription0055F061	[J5]The speed command is too large
ErrorDescription0055F062	[J5]The deviation between target and current position is too large
ErrorDescription0055F063	[J5]Motor hold protection: duty command over
ErrorDescription0055F064	[J5]Motor hold protection: current feedback over
ErrorDescription0055F071	[J5]Gate Driver diagnosis error
ErrorDescription0055F072	[J5]The temperature of PCB is too high
ErrorDescription0055F073	[J5]The acceleration of G sensor is out of range
ErrorDescription0055F074	[J5]EEPROM polling timeout

ErrorDescription0055F075	[J5]Dual encoder deviation too large
ErrorDescription0055F0A4	[J5]Flash mismatch among L0 and SL1/2
ErrorDescription0055F0A5	[J5]CM error (warning)
ErrorDescription0055F0A6	[J5]ESI and EEPROM SN mismatch (warning)
ErrorDescription0055F111	[J5]EEPROM data load fail
ErrorDescription0055F112	[J5]G sensor initialization fail
ErrorDescription0055F113	[J5]Gate driver set fail
ErrorDescription0055F114	[J5]Power supply status error
ErrorDescription0055F115	[J5]Encoder architecture mismatch
ErrorDescription0055F116	[J5]Find zone of absolute position fail
ErrorDescription0055F117	[J5]Absolute position mapping Error
ErrorDescription0055F118	[J5]Absolute position over limit at startup
ErrorDescription0055F119	[J5]The resistance of UVW of motor is abnormal
ErrorDescription0055F11A	[J5]The connection of UVW of motor is not correct
ErrorDescription0055F11B	[J5]Encoder connection failed
ErrorDescription0055F11C	[J5]Encoder diagnosis error during init process
ErrorDescription0055F121	[J5]Runin: DCBus V calibration fail
ErrorDescription0055F122	[J5]Runin: G sensor calibration process is NG
ErrorDescription0055F123	[J5]Runin: G sensor calibration result is out of limit
ErrorDescription0055F124	[J5]Runin: Encoder check fail: Z signal is abnormal
ErrorDescription0055F125	[J5]Runin: Encoder check fail: AB signal is NG
ErrorDescription0055F126	[J5]Runin: Encoder check fail: the sequence of UVW wire is reverse
ErrorDescription0055F127	[J5]Runin: Index calibration process fail
ErrorDescription0055F128	[J5]Runin: index calibration result fail
ErrorDescription0055F129	[J5]"Z search" timeout
ErrorDescription0055F12A	[J5]Runin: Multiturn calibration fail
ErrorDescription0055F12B	[J5]The parameters of joint module are abnormal
ErrorDescription0055F131	[J5]Illegal interrupt to MCU
ErrorDescription0055F132	[J5]The watchdog of MCU is timeout
ErrorDescription0055F133	[J5]S48V drop
ErrorDescription0055F134	[J5]The communication of EtherCAT is timeout
ErrorDescription0055F135	[J5]Joint movement range is NG in brake release status
ErrorDescription0055F136	[J5]Brake off current is abnormal
ErrorDescription0055F137	[J5]S48V under low lim
ErrorDescription0055F138	[J5]S48V over high lim
ErrorDescription0055F139	[J5]M48V drop
ErrorDescription0055F141	[J5]Encoder 1 diagnosis error
ErrorDescription0055F142	[J5]Encoder 2 diagnosis error
ErrorDescription0055F143	[J5]Encoder 3 diagnosis error
ErrorDescription0055F144	[J5]Encoder 4 diagnosis error
ErrorDescription0055F145	[J5]Input side Encoder miss Z signal
ErrorDescription0055F146	[J4]Output side Encoder detect multiple Z signals in single-turn
ErrorDescription0055F147	[J5]Output side Encoder miss Z signal
ErrorDescription0055F148	[J5]Output side Encoder detect multiple Z signal in single-turn
ErrorDescription0055F149	[J5]Switch target encoder fail
ErrorDescription0055F1A1	[J5]FW version doesn't match HW version
ErrorDescription0055F1A2	[J5]CM FW version doesn't match CPU1 FW version



ErrorDescription0055F1A3	[J5]Flash history record load fail
ErrorDescription0055F1A7	[J5]FW and EEPROM type mismatch
ErrorDescription0055FF20	[J5][Error][Hardware]Solenoid current is NG
ErrorDescription0055FF21	[J5][Error][Hardware]Joint movement range is NG in brake release status
ErrorDescription0055FFA0	[J5][Error][Hardware]The voltage on DCBUS is too low (40V)
ErrorDescription0055FFA1	[J5][Error][Hardware]The voltage on DCBUS is too high (60V)
ErrorDescription0055FFA2	[J5]The acceleration on X direction of G sensor is out of range
ErrorDescription0055FFA3	[J5]The acceleration on Y direction of G sensor is out of range
ErrorDescription0055FFA4	[J5]The acceleration on Z direction of G sensor is out of range
ErrorDescription0055FFA5	[J5][Error][Hardware]The temperature on PCB is too high (90 degree Celsius)
ErrorDescription0055FFA6	[J5][Error][Hardware]The current in U phase of motor is too high
ErrorDescription0055FFA7	[J5][Error][Hardware]The current in V phase of motor is too high
ErrorDescription0055FFA8	[J5][Error][Hardware]The current in W phase of motor is too high
ErrorDescription0055FFA9	[J5]The overcurrent is protected by current sensor of U phase
ErrorDescription0055FFAA	[J5]The overcurrent is protected by current sensor of V phase
ErrorDescription0055FFAB	[J5][Error][Hardware]The protection is on for motor hold
ErrorDescription0055FFAC	[J5]The initial angle of three phase of motor is not correct
ErrorDescription0055FFAD	[J5]The index angle of encoder is not calibrated
ErrorDescription0055FFAE	[J5][Error][Hardware]Overcurrent in DCBUS
ErrorDescription0055FFAF	[J5][Error][System]The communication of EtherCAT is timeout
ErrorDescription0055FFB1	[J5][Error][System]The communication of SPI is timeout
ErrorDescription0055FFB2	[J5]Illegal interrupt to MCU
ErrorDescription0055FFB3	[J5]The watchdog of MCU is timeout
ErrorDescription0055FFB4	[J5]The initialization of joint coordinate is timeout
ErrorDescription0055FFB5	[J5]FW version doesn't match HW version
ErrorDescription0055FFB6	[J5]The process in main loop is timeout
ErrorDescription0055FFB7	[J5]Brake release failed.
ErrorDescription0055FFB8	[J5][Error][Hardware]Gate Driver NG
ErrorDescription0055FFB9	[J5][Error][Hardware]MOSFET NG
ErrorDescription0055FFBA	[J5][Error][Hardware]Current Sensor NG
ErrorDescription0055FFC0	[J5]The deviation is too high when initializing joint coordinate
ErrorDescription0055FFC1	[J5]Runin process R2: Z index miss
ErrorDescription0055FFC2	[J5]Runin process R2: multi Z index happened
ErrorDescription0055FFC3	[J5]Runin process R2: U signal NG
ErrorDescription0055FFC4	[J5]Runin process R2: V signal NG
ErrorDescription0055FFC5	[J5]Runin process R2: W signal NG
ErrorDescription0055FFC6	[J5]Runin process R2: the sequence of UVW is NG
ErrorDescription0055FFC7	[J5]Runin process R2: AB signal is NG
ErrorDescription0055FFC8	[J5]Failure in loading data from EEPROM
ErrorDescription0055FFC9	[J5]The electrical angle of motor is not correct (warning)
ErrorDescription0055FFCA	[J5][Error][Hardware]Multi Z index happened in encoder output
ErrorDescription0055FFCB	[J5]The deviation between command and current position is too high
ErrorDescription0055FFCC	[J5][Error][Hardware]The Z index signal is missing
ErrorDescription0055FFCD	[J5][Error][Hardware]Encoder connection failed
ErrorDescription0055FFCE	[J5][Error][Hardware]The compensation of encoder signal is too high
ErrorDescription0055FFCF	[J5][Error][Hardware]The protection is on for motor hold (type 2)
ErrorDescription0055FFD0	[J5]The UVW signal of encoder is NG

ErrorDescription0055FFD1	[J5][Error][Hardware]The data is abnormal when reading magnetic encoder.
ErrorDescription0055FFD2	[J5][Error][Hardware]The magnet is NG judged by magnetic encoder
ErrorDescription0055FFD3	[J5][Error][Hardware]The origin of joint module is out of preset
ErrorDescription0055FFD4	[J5]The data in EEPROM is dislocated
ErrorDescription0055FFD5	[J5]The parameters for joint module are abnormal
ErrorDescription0055FFD6	[J5]The process of I2C control flow is out of control
ErrorDescription0055FFD7	[J5]Runin process R2: index calibration failed
ErrorDescription0055FFD8	[J5][Hardware][Error]The resistance of UVW of motor is abnormal
ErrorDescription0055FFD9	[J5][Hardware][Error]The connection of UVW of motor is not correct
ErrorDescription0055FFDA	[J5]Runin process R2: the current in UVW phase is NG
ErrorDescription0055FFDB	[J5]Runin process R4: UVW calibration result is out of limit
ErrorDescription0055FFDC	[J5]Runin process : G sensor calibration result is out of limit
ErrorDescription0055FFDD	[J5]a error occurs when command changes the control mode.
ErrorDescription0055FFDE	[J5]Changing EtherCAT ESM when PDS is in OP mode
ErrorDescription0055FFDF	[J5]Unknown EtherCAT ESM command
ErrorDescription0055FFE0	[J5][Hardware][Error]The voltage of DC bus is low in EtherCAT OP mode
ErrorDescription0055FFE1	[J5]Online multiturn calibration failed
ErrorDescription0055FFE2	[J5]The magnetic encoder data is not stable in the position initialization process
ErrorDescription0055FFE3	[J5]The joint angle between "power on" and "position initialization" exceeds limit
ErrorDescription0055FFE4	[J5][Error][System]The position initialization process is timeout ("Z search" is not finished)
ErrorDescription0055FFE5	[J5]The position initialization process is timeout
ErrorDescription0055FFE6	[J5]The result is NG in position initialization process
ErrorDescription0055FFE7	[J5]Runin process: the process of g sensor calibration is NG
ErrorDescription0055FFE8	[J5][Hardware][Error]The output of g sensor is NG
ErrorDescription0055FFE9	[J5]The check sum result from EEPROM data is abnormal
ErrorDescription0055FFEA	[J5][Hardware][Error]The voltage of 5V is NG
ErrorDescription0055FFEB	[J5][Hardware][Error]The voltage of 12V is NG
ErrorDescription0055FFEC	[J5]The ADC compensation is out of limit
ErrorDescription0055FFED	[J5][Error][Hardware]The compensation of encoder signal is too high in ABS mode
ErrorDescription0055FFEE	[J5]The deviation is too high between latching index and position initialization process
ErrorDescription0055FFEF	[J5]The parameters of magnetic encoder are abnormal
ErrorDescription00650000	[J6]No Error
ErrorDescription0065F051	[J6]The current in U phase of motor is too high
ErrorDescription0065F052	[J6]The current in V phase of motor is too high
ErrorDescription0065F053	[J6]The current in W phase of motor is too high
ErrorDescription0065F054	[J6]Overcurrent in DCBUS
ErrorDescription0065F055	[J6]The voltage on DCBUS is too low
ErrorDescription0065F056	[J6]The voltage on DCBUS is too high
ErrorDescription0065F057	[J6]The compensation of ADC drift is out of limit
ErrorDescription0065F058	[J6]1.65V out of limit
ErrorDescription0065F059	[J6]12V out of limit
ErrorDescription0065F05A	[J6]6V out of limit
ErrorDescription0065F05B	[J6]3.3V out of limit
ErrorDescription0065F05C	[J6]1.2V out of limit
ErrorDescription0065F05D	[J6]Power supply status error
ErrorDescription0065F061	[J6]The speed command is too large
ErrorDescription0065F062	[J6]The deviation between target and current position is too large



ErrorDescription0065F063	[J6]Motor hold protection: duty command over
ErrorDescription0065F064	[J6]Motor hold protection: current feedback over
ErrorDescription0065F071	[J6]Gate Driver diagnosis error
ErrorDescription0065F072	[J6]The temperature of PCB is too high
ErrorDescription0065F073	[J6]The acceleration of G sensor is out of range
ErrorDescription0065F074	[J6]EEPROM polling timeout
ErrorDescription0065F075	[J6]Dual encoder deviation too large
ErrorDescription0065F0A4	[J6]Flash mismatch among L0 and SL1/2
ErrorDescription0065F0A5	[J6]CM error (warning)
ErrorDescription0065F0A6	[J6]ESI and EEPROM SN mismatch (warning)
ErrorDescription0065F111	[J6]EEPROM data load fail
ErrorDescription0065F112	[J6]G sensor initialization fail
ErrorDescription0065F113	[J6]Gate driver set fail
ErrorDescription0065F114	[J6]Power supply status error
ErrorDescription0065F115	[J6]Encoder architecture mismatch
ErrorDescription0065F116	[J6]Find zone of absolute position fail
ErrorDescription0065F117	[J6]Absolute position mapping Error
ErrorDescription0065F118	[J6]Absolute position over limit at startup
ErrorDescription0065F119	[J6]The resistance of UVW of motor is abnormal
ErrorDescription0065F11A	[J6]The connection of UVW of motor is not correct
ErrorDescription0065F11B	[J6]Encoder connection failed
ErrorDescription0065F11C	[J6]Encoder diagnosis error during init process
ErrorDescription0065F121	[J6]Runin: DCBus V calibration fail
ErrorDescription0065F122	[J6]Runin: G sensor calibration process is NG
ErrorDescription0065F123	[J6]Runin: G sensor calibration result is out of limit
ErrorDescription0065F124	[J6]Runin: Encoder check fail: Z signal is abnormal
ErrorDescription0065F125	[J6]Runin: Encoder check fail: AB signal is NG
ErrorDescription0065F126	[J6]Runin: Encoder check fail: the sequence of UVW wire is reverse
ErrorDescription0065F127	[J6]Runin: Index calibration process fail
ErrorDescription0065F128	[J6]Runin: index calibration result fail
ErrorDescription0065F129	[J6]"Z search" timeout
ErrorDescription0065F12A	[J6]Runin: Multiturn calibration fail
ErrorDescription0065F12B	[J6]The parameters of joint module are abnormal
ErrorDescription0065F131	[J6]Illegal interrupt to MCU
ErrorDescription0065F132	[J6]The watchdog of MCU is timeout
ErrorDescription0065F133	[J6]S48V drop
ErrorDescription0065F134	[J6]The communication of EtherCAT is timeout
ErrorDescription0065F135	[J6]Joint movement range is NG in brake release status
ErrorDescription0065F136	[J6]Brake off current is abnormal
ErrorDescription0065F137	[J6]S48V under low lim
ErrorDescription0065F138	[J6]S48V over high lim
ErrorDescription0065F139	[J6]M48V drop
ErrorDescription0065F141	[J6]Encoder 1 diagnosis error
ErrorDescription0065F142	[J6]Encoder 2 diagnosis error
ErrorDescription0065F143	[J6]Encoder 3 diagnosis error
ErrorDescription0065F144	[J6]Encoder 4 diagnosis error
ErrorDescription0065F145	[J6]Input side Encoder miss Z signal

ErrorDescription0065F146	[J5]Output side Encoder detect multiple Z signals in single-turn
ErrorDescription0065F147	[J6]Output side Encoder miss Z signal
ErrorDescription0065F148	[J6]Output side Encoder detect multiple Z signal in single-turn
ErrorDescription0065F149	[J6]Switch target encoder fail
ErrorDescription0065F1A1	[J6]FW version doesn't match HW version
ErrorDescription0065F1A2	[J6]CM FW version doesn't match CPU1 FW version
ErrorDescription0065F1A3	[J6]Flash history record load fail
ErrorDescription0065F1A7	[J6]FW and EEPROM type mismatch
ErrorDescription0065FF20	[J6][Error][Hardware]Solenoid current is NG
ErrorDescription0065FF21	[J6][Error][Hardware]Joint movement range is NG in brake release status
ErrorDescription0065FFA0	[J6][Error][Hardware]The voltage on DCBUS is too low (40V)
ErrorDescription0065FFA1	[J6][Error][Hardware]The voltage on DCBUS is too high (60V)
ErrorDescription0065FFA2	[J6]The acceleration on X direction of G sensor is out of range
ErrorDescription0065FFA3	[J6]The acceleration on Y direction of G sensor is out of range
ErrorDescription0065FFA4	[J6]The acceleration on Z direction of G sensor is out of range
ErrorDescription0065FFA5	[J6][Error][Hardware]The temperature on PCB is too high (90 degree Celsius)
ErrorDescription0065FFA6	[J6][Error][Hardware]The current in U phase of motor is too high
ErrorDescription0065FFA7	[J6][Error][Hardware]The current in V phase of motor is too high
ErrorDescription0065FFA8	[J6][Error][Hardware]The current in W phase of motor is too high
ErrorDescription0065FFA9	[J6]The overcurrent is protected by current sensor of U phase
ErrorDescription0065FFAA	[J6]The overcurrent is protected by current sensor of V phase
ErrorDescription0065FFAB	[J6][Error][Hardware]The protection is on for motor hold
ErrorDescription0065FFAC	[J6]The initial angle of three phase of motor is not correct
ErrorDescription0065FFAD	[J6]The index angle of encoder is not calibrated
ErrorDescription0065FFAE	[J6][Error][Hardware]Overcurrent in DCBUS
ErrorDescription0065FFAF	[J6][Error][System]The communication of EtherCAT is timeout
ErrorDescription0065FFB1	[J6][Error][System]The communication of SPI is timeout
ErrorDescription0065FFB2	[J6]Illegal interrupt to MCU
ErrorDescription0065FFB3	[J6]The watchdog of MCU is timeout
ErrorDescription0065FFB4	[J6]The initialization of joint coordinate is timeout
ErrorDescription0065FFB5	[J6]FW version doesn't match HW version
ErrorDescription0065FFB6	[J6]The process in main loop is timeout
ErrorDescription0065FFB7	[J6]Brake release failed.
ErrorDescription0065FFB8	[J6][Error][Hardware]Gate Driver NG
ErrorDescription0065FFB9	[J6][Error][Hardware]MOSFET NG
ErrorDescription0065FFBA	[J6][Error][Hardware]Current Sensor NG
ErrorDescription0065FFC0	[J6]The deviation is too high when initializing joint coordinate
ErrorDescription0065FFC1	[J6]Runin process R2: Z index miss
ErrorDescription0065FFC2	[J6]Runin process R2: multi Z index happened
ErrorDescription0065FFC3	[J6]Runin process R2: U signal NG
ErrorDescription0065FFC4	[J6]Runin process R2: V signal NG
ErrorDescription0065FFC5	[J6]Runin process R2: W signal NG
ErrorDescription0065FFC6	[J6]Runin process R2: the sequence of UVW is NG
ErrorDescription0065FFC7	[J6]Runin process R2: AB signal is NG
ErrorDescription0065FFC8	[J6]Failure in loading data from EEPROM
ErrorDescription0065FFC9	[J6]The electrical angle of motor is not correct (warning)
ErrorDescription0065FFCA	[J6][Error][Hardware]Multi Z index happened in encoder output

ErrorDescription0065FFCB	[J6]The deviation between command and current position is too high
ErrorDescription0065FFCC	[J6][Error][Hardware]The Z index signal is missing
ErrorDescription0065FFCD	[J6][Error][Hardware]Encoder connection failed
ErrorDescription0065FFCE	[J6][Error][Hardware]The compensation of encoder signal is too high
ErrorDescription0065FFCF	[J6][Error][Hardware]The protection is on for motor hold (type 2)
ErrorDescription0065FFD0	[J6]The UVW signal of encoder is NG
ErrorDescription0065FFD1	[J6][Error][Hardware]The data is abnormal when reading magnetic encoder.
ErrorDescription0065FFD2	[J6][Error][Hardware]The magnet is NG judged by magnetic encoder
ErrorDescription0065FFD3	[J6][Error][Hardware]The origin of joint module is out of preset
ErrorDescription0065FFD4	[J6]The data in EEPROM is dislocated
ErrorDescription0065FFD5	[J6]The parameters for joint module are abnormal
ErrorDescription0065FFD6	[J6]The process of I2C control flow is out of control
ErrorDescription0065FFD7	[J6]Runin process R2: index calibration failed
ErrorDescription0065FFD8	[J6][Hardware][Error]The resistance of UVW of motor is abnormal
ErrorDescription0065FFD9	[J6][Hardware][Error]The connection of UVW of motor is not correct
ErrorDescription0065FFDA	[J6]Runin process R2: the current in UVW phase is NG
ErrorDescription0065FFDB	[J6]Runin process R4: UVW calibration result is out of limit
ErrorDescription0065FFDC	[J6]Runin process : G sensor calibration result is out of limit
ErrorDescription0065FFDD	[J6]a error occurs when command changes the control mode.
ErrorDescription0065FFDE	[J6]Changing EtherCAT ESM when PDS is in OP mode
ErrorDescription0065FFDF	[J6]Unknown EtherCAT ESM command
ErrorDescription0065FFE0	[J6][Hardware][Error]The voltage of DC bus is low in EtherCAT OP mode
ErrorDescription0065FFE1	[J6]Online multiturn calibration failed
ErrorDescription0065FFE2	[J6]The magnetic encoder data is not stable in the position initialization process
ErrorDescription0065FFE3	[J6]The joint angle between "power on" and "position initialization" exceeds limit
ErrorDescription0065FFE4	[J6][Error][System]The position initialization process is timeout ("Z search" is not finished)
ErrorDescription0065FFE5	[J6]The position initialization process is timeout
ErrorDescription0065FFE6	[J6]The result is NG in position initialization process
ErrorDescription0065FFE7	[J6]Runin process: the process of g sensor calibration is NG
ErrorDescription0065FFE8	[J6][Hardware][Error]The output of g sensor is NG
ErrorDescription0065FFE9	[J6]The check sum result from EEPROM data is abnormal
ErrorDescription0065FFEA	[J6][Hardware][Error]The voltage of 5V is NG
ErrorDescription0065FFEB	[J6][Hardware][Error]The voltage of 12V is NG
ErrorDescription0065FFEC	[J6]The ADC compensation is out of limit
ErrorDescription0065FFED	[J6][Error][Hardware]The compensation of encoder signal is too high in ABS mode
ErrorDescription0065FFEE	[J6]The deviation is too high between latching index and position initialization process
ErrorDescription0065FFEF	[J6]The parameters of magnetic encoder are abnormal
ErrorDescription0016AA11	[J1]RAM M0 march error
ErrorDescription0016AA12	[J1]RAM M1 march error
ErrorDescription0016AA13	[J1]RAM LS0 march error
ErrorDescription0016AA14	[J1]RAM LS1 march error
ErrorDescription0016AA15	[J1]RAM LS2 march error
ErrorDescription0016AA16	[J1]RAM LS3 march error
ErrorDescription0016AA17	[J1]RAM LS4 march error
ErrorDescription0016AA18	[J1]RAM LS5 march error
ErrorDescription0016AA19	[J1]RAM LS6 march error
ErrorDescription0016AA1A	[J1]RAM LS7 march error

ErrorDescription0016AA1B	[J1]RAM GS0-1 march error
ErrorDescription0016AA1C	[J1]RAM GS0-2 march error
ErrorDescription0016AA1D	[J1]RAM GS1-1 march error
ErrorDescription0016AA1E	[J1]RAM GS1-2 march error
ErrorDescription0016AA1F	[J1]RAM GS2-1 march error
ErrorDescription0016AA21	[J1]RAM GS2-2 march error
ErrorDescription0016AA22	[J1]RAM GS3-1 march error
ErrorDescription0016AA23	[J1]RAM GS3-2 march error
ErrorDescription0016AA24	[J6]Output side Encoder detect multiple Z signals in single-turn
ErrorDescription0016AA25	[J1]SWBIST error
ErrorDescription0016AA2C	[J1]HWBIST error
ErrorDescription0016AA2E	[J1]Flash ECC error
ErrorDescription0016AA2F	[J1]Flash CRC error
ErrorDescription0016AA33	[J1]Watchdog timeout
ErrorDescription0016AA34	[J1]Sync step timeout
ErrorDescription0016AA35	[J1]Sync step timeout
ErrorDescription0016AA36	[J1]Sync step timeout
ErrorDescription0016AA37	[J1]Wrong Logic ID detected
ErrorDescription0016AA38	[J1]Timer0 INT out of range
ErrorDescription0016AA39	[J1]Timer0 INT out of range
ErrorDescription0016AA3A	[J1]Timer1 INT out of range
ErrorDescription0016AA3B	[J1]Timer1 INT out of range
ErrorDescription0016AA3C	[J1]Async digital input
ErrorDescription0016BB11	[J1]Cross check timeout
ErrorDescription0016BB12	[J1]Cross check timeout
ErrorDescription0016BB13	[J1]Cross check timeout
ErrorDescription0016BB14	[J1]Cross check timeout
ErrorDescription0016BB15	[J1]Cross check timeout
ErrorDescription0016BB16	[J1]Cross check timeout
ErrorDescription0016BB17	[J1]CRC cross check error
ErrorDescription0016BB18	[J1]CRC cross check error
ErrorDescription0016BB19	[J1]Cross check timeout
ErrorDescription0016BB1A	[J1]Tmsafe frame error
ErrorDescription0016BB1B	[J1]Tmsafe slave ID error
ErrorDescription0016BB1C	[J1]ADC cross check error
ErrorDescription0016BB1D	[J1]ADC cross check error
ErrorDescription0016BB1E	[J1]QEP cross check error
ErrorDescription0016BB1F	[J1]SL version mismatch
ErrorDescription0016CC11	[J1]1.2V out of range
ErrorDescription0016CC12	[J1]1.2V out of range
ErrorDescription0016CC13	[J1]3.3V out of range
ErrorDescription0016CC14	[J1]3.3V out of range
ErrorDescription0016CC15	[J1]1.2V out of range
ErrorDescription0016CC16	[J1]1.2V out of range
ErrorDescription0016CC17	[J1]3.3V out of range
ErrorDescription0016CC18	[J1]48V out of range
ErrorDescription0016CC1B	[J1]48V out of range

ErrorDescription0016CC1C	[J1]48V out of range
ErrorDescription0016CC1D	[J1]12V out of range
ErrorDescription0016CC1E	[J1]12V out of range
ErrorDescription0016CC1F	[J1]6V out of range
ErrorDescription0016CC21	[J1]6V out of range
ErrorDescription0016CC22	[J1]5V out of range
ErrorDescription0016CC23	[J1]5V out of range
ErrorDescription0016CC24	[J1]5V out of range
ErrorDescription0016CC25	[J1]5V out of range
ErrorDescription0016DD15	[J1]1.2V self check error
ErrorDescription0016DD16	[J1]3.3V self check error
ErrorDescription0016DD17	[J1]1.2V self check error
ErrorDescription0016DD18	[J1]48V self check error
ErrorDescription0016DD1A	[J1]48V self check error
ErrorDescription0016DD1B	[J1]12V self check error
ErrorDescription0016DD1C	[J1]6V self check error
ErrorDescription0016DD1D	[J1]1.9V self check error
ErrorDescription0016DD1E	[J1]Device temperature self check error
ErrorDescription0016DD1F	[J1]Device temperature self check error
ErrorDescription0016DD21	[J1]encoder 1 self check error
ErrorDescription0016DD22	[J1]encoder 2 self check error
ErrorDescription0016DD23	[J1]encoder 3 self check error
ErrorDescription0016DD24	[J1]3-phase current error
ErrorDescription0016DD25	[J1]3-phase current error
ErrorDescription0016DD26	[J1]3-phase current error
ErrorDescription0016DD27	[J1]3-phase current error
ErrorDescription0016DD28	[J1]encoder cross check error
ErrorDescription0016DD29	[J1]encoder 1 latch signal error
ErrorDescription0016DD2A	[J1]encoder 2 latch signal error
ErrorDescription0016DD2B	[J1]encoder 1 cross check error
ErrorDescription0016DD2C	[J1]encoder 2 cross check error
ErrorDescription0016DD2D	[J1]5V cross check error
ErrorDescription0016DD2E	[J1]5V cross check error
ErrorDescription0016EE11	[J1]Safety parameter timeout
ErrorDescription0016EE12	[J1]Invalid Safety parameter
ErrorDescription0016EE13	[J1]Encoder SSI read fail
ErrorDescription0016EE14	[J1]Safety parameter load fail
ErrorDescription0016EE15	[J1]Previous position mismatch
ErrorDescription0016EE16	[J1]Previous position mismatch
ErrorDescription0016EE17	[J1]Previous position mismatch
ErrorDescription0016EE18	[J1]Tmsafe command error
ErrorDescription0016EE19	[J1]Encoder init timeout
ErrorDescription0016EE1A	[J1]absolute position initialization timeout
ErrorDescription0016EE1B	[J1]Encoder SSI cross check fail
ErrorDescription0016F003	[J1]Previous position mismatch
ErrorDescription0016F004	[J1]Absolute position mismatch
ErrorDescription0016F005	[J1]Previous position read fail

ErrorDescription0016F00E	[J1]Fail to map 2-side encoder
ErrorDescription0016F01A	[J1]Fail to map 2-side encoder
ErrorDescription0026AA11	[J2]RAM M0 march error
ErrorDescription0026AA12	[J2]RAM M1 march error
ErrorDescription0026AA13	[J2]RAM LS0 march error
ErrorDescription0026AA14	[J2]RAM LS1 march error
ErrorDescription0026AA15	[J2]RAM LS2 march error
ErrorDescription0026AA16	[J2]RAM LS3 march error
ErrorDescription0026AA17	[J2]RAM LS4 march error
ErrorDescription0026AA18	[J2]RAM LS5 march error
ErrorDescription0026AA19	[J2]RAM LS6 march error
ErrorDescription0026AA1A	[J2]RAM LS7 march error
ErrorDescription0026AA1B	[J2]RAM GS0-1 march error
ErrorDescription0026AA1C	[J2]RAM GS0-2 march error
ErrorDescription0026AA1D	[J2]RAM GS1-1 march error
ErrorDescription0026AA1E	[J2]RAM GS1-2 march error
ErrorDescription0026AA1F	[J2]RAM GS2-1 march error
ErrorDescription0026AA21	[J2]RAM GS2-2 march error
ErrorDescription0026AA22	[J2]RAM GS3-1 march error
ErrorDescription0026AA23	[J2]RAM GS3-2 march error
ErrorDescription0026AA24	[J2]SWBIST error
ErrorDescription0026AA25	[J2]SWBIST error
ErrorDescription0026AA2C	[J2]HWBIST error
ErrorDescription0026AA2E	[J2]Flash ECC error
ErrorDescription0026AA2F	[J2]Flash CRC error
ErrorDescription0026AA33	[J2]Watchdog timeout
ErrorDescription0026AA34	[J2]Sync step timeout
ErrorDescription0026AA35	[J2]Sync step timeout
ErrorDescription0026AA36	[J2]Sync step timeout
ErrorDescription0026AA37	[J2]Wrong Logic ID detected
ErrorDescription0026AA38	[J2]Timer0 INT out of range
ErrorDescription0026AA39	[J2]Timer0 INT out of range
ErrorDescription0026AA3A	[J2]Timer1 INT out of range
ErrorDescription0026AA3B	[J2]Timer1 INT out of range
ErrorDescription0026AA3C	[J2]Async digital input
ErrorDescription0026BB11	[J2]Cross check timeout
ErrorDescription0026BB12	[J2]Cross check timeout
ErrorDescription0026BB13	[J2]Cross check timeout
ErrorDescription0026BB14	[J2]Cross check timeout
ErrorDescription0026BB15	[J2]Cross check timeout
ErrorDescription0026BB16	[J2]Cross check timeout
ErrorDescription0026BB17	[J2]CRC cross check error
ErrorDescription0026BB18	[J2]CRC cross check error
ErrorDescription0026BB19	[J2]Cross check timeout
ErrorDescription0026BB1A	[J2]Tmsafe frame error
ErrorDescription0026BB1B	[J2]Tmsafe slave ID error
ErrorDescription0026BB1C	[J2]ADC cross check error



ErrorDescription0026BB1D	[J2]ADC cross check error
ErrorDescription0026BB1E	[J2]QEP cross check error
ErrorDescription0026BB1F	[J2]SL version mismatch
ErrorDescription0026CC11	[J2]1.2V out of range
ErrorDescription0026CC12	[J2]1.2V out of range
ErrorDescription0026CC13	[J2]3.3V out of range
ErrorDescription0026CC14	[J2]3.3V out of range
ErrorDescription0026CC15	[J2]1.2V out of range
ErrorDescription0026CC16	[J2]1.2V out of range
ErrorDescription0026CC17	[J2]3.3V out of range
ErrorDescription0026CC18	[J2]48V out of range
ErrorDescription0026CC1B	[J2]48V out of range
ErrorDescription0026CC1C	[J2]48V out of range
ErrorDescription0026CC1D	[J2]12V out of range
ErrorDescription0026CC1E	[J2]12V out of range
ErrorDescription0026CC1F	[J2]6V out of range
ErrorDescription0026CC21	[J2]6V out of range
ErrorDescription0026CC22	[J2]5V out of range
ErrorDescription0026CC23	[J2]5V out of range
ErrorDescription0026CC24	[J2]5V out of range
ErrorDescription0026CC25	[J2]5V out of range
ErrorDescription0026DD15	[J2]1.2V self check error
ErrorDescription0026DD16	[J2]3.3V self check error
ErrorDescription0026DD17	[J2]1.2V self check error
ErrorDescription0026DD18	[J2]48V self check error
ErrorDescription0026DD1A	[J2]48V self check error
ErrorDescription0026DD1B	[J2]12V self check error
ErrorDescription0026DD1C	[J2]6V self check error
ErrorDescription0026DD1D	[J2]1.9V self check error
ErrorDescription0026DD1E	[J2]Device temperature self check error
ErrorDescription0026DD1F	[J2]Device temperature self check error
ErrorDescription0026DD21	[J2]encoder 1 self check error
ErrorDescription0026DD22	[J2]encoder 2 self check error
ErrorDescription0026DD23	[J2]encoder 3 self check error
ErrorDescription0026DD24	[J2]3-phase current error
ErrorDescription0026DD25	[J2]3-phase current error
ErrorDescription0026DD26	[J2]3-phase current error
ErrorDescription0026DD27	[J2]3-phase current error
ErrorDescription0026DD28	[J2]encoder cross check error
ErrorDescription0026DD29	[J2]encoder 1 latch signal error
ErrorDescription0026DD2A	[J2]encoder 2 latch signal error
ErrorDescription0026DD2B	[J2]encoder 1 cross check error
ErrorDescription0026DD2C	[J2]encoder 2 cross check error
ErrorDescription0026DD2D	[J2]5V cross check error
ErrorDescription0026DD2E	[J2]5V cross check error
ErrorDescription0026EE11	[J2]Safety parameter timeout
ErrorDescription0026EE12	[J2]Invalid Safety parameter

ErrorDescription0026EE13	[J2]Encoder SSI read fail
ErrorDescription0026EE14	[J2]Safety parameter load fail
ErrorDescription0026EE15	[J2]Previous position mismatch
ErrorDescription0026EE16	[J2]Previous position mismatch
ErrorDescription0026EE17	[J2]Previous position mismatch
ErrorDescription0026EE18	[J2]Tmsafe command error
ErrorDescription0026EE19	[J2]Encoder init timeout
ErrorDescription0026EE1A	[J2]absolute position initialization timeout
ErrorDescription0026EE1B	[J2]Encoder SSI cross check fail
ErrorDescription0026F003	[J2]Previous position mismatch
ErrorDescription0026F004	[J2]Absolute position mismatch
ErrorDescription0026F005	[J2]Previous position read fail
ErrorDescription0026F00E	[J2]Fail to map 2-side encoder
ErrorDescription0026F01A	[J2]Fail to map 2-side encoder
ErrorDescription0036AA11	[J3]RAM M0 march error
ErrorDescription0036AA12	[J3]RAM M1 march error
ErrorDescription0036AA13	[J3]RAM LS0 march error
ErrorDescription0036AA14	[J3]RAM LS1 march error
ErrorDescription0036AA15	[J3]RAM LS2 march error
ErrorDescription0036AA16	[J3]RAM LS3 march error
ErrorDescription0036AA17	[J3]RAM LS4 march error
ErrorDescription0036AA18	[J3]RAM LS5 march error
ErrorDescription0036AA19	[J3]RAM LS6 march error
ErrorDescription0036AA1A	[J3]RAM LS7 march error
ErrorDescription0036AA1B	[J3]RAM GS0-1 march error
ErrorDescription0036AA1C	[J3]RAM GS0-2 march error
ErrorDescription0036AA1D	[J3]RAM GS1-1 march error
ErrorDescription0036AA1E	[J3]RAM GS1-2 march error
ErrorDescription0036AA1F	[J3]RAM GS2-1 march error
ErrorDescription0036AA21	[J3]RAM GS2-2 march error
ErrorDescription0036AA22	[J3]RAM GS3-1 march error
ErrorDescription0036AA23	[J3]RAM GS3-2 march error
ErrorDescription0036AA24	[J3]SWBIST error
ErrorDescription0036AA25	[J3]SWBIST error
ErrorDescription0036AA2C	[J3]HWBIST error
ErrorDescription0036AA2E	[J3]Flash ECC error
ErrorDescription0036AA2F	[J3]Flash CRC error
ErrorDescription0036AA33	[J3]Watchdog timeout
ErrorDescription0036AA34	[J3]Sync step timeout
ErrorDescription0036AA35	[J3]Sync step timeout
ErrorDescription0036AA36	[J3]Sync step timeout
ErrorDescription0036AA37	[J3]Wrong Logic ID detected
ErrorDescription0036AA38	[J3]Timer0 INT out of range
ErrorDescription0036AA39	[J3]Timer0 INT out of range
ErrorDescription0036AA3A	[J3]Timer1 INT out of range
ErrorDescription0036AA3B	[J3]Timer1 INT out of range
ErrorDescription0036AA3C	[J3]Async digital input



ErrorDescription0036BB11	[J3]Cross check timeout
ErrorDescription0036BB12	[J3]Cross check timeout
ErrorDescription0036BB13	[J3]Cross check timeout
ErrorDescription0036BB14	[J3]Cross check timeout
ErrorDescription0036BB15	[J3]Cross check timeout
ErrorDescription0036BB16	[J3]Cross check timeout
ErrorDescription0036BB17	[J3]CRC cross check error
ErrorDescription0036BB18	[J3]CRC cross check error
ErrorDescription0036BB19	[J3]Cross check timeout
ErrorDescription0036BB1A	[J3]Tmsafe frame error
ErrorDescription0036BB1B	[J3]Tmsafe slave ID error
ErrorDescription0036BB1C	[J3]ADC cross check error
ErrorDescription0036BB1D	[J3]ADC cross check error
ErrorDescription0036BB1E	[J3]QEP cross check error
ErrorDescription0036BB1F	[J3]SL version mismatch
ErrorDescription0036CC11	[J3]1.2V out of range
ErrorDescription0036CC12	[J3]1.2V out of range
ErrorDescription0036CC13	[J3]3.3V out of range
ErrorDescription0036CC14	[J3]3.3V out of range
ErrorDescription0036CC15	[J3]1.2V out of range
ErrorDescription0036CC16	[J3]1.2V out of range
ErrorDescription0036CC17	[J3]3.3V out of range
ErrorDescription0036CC18	[J3]48V out of range
ErrorDescription0036CC1B	[J3]48V out of range
ErrorDescription0036CC1C	[J3]48V out of range
ErrorDescription0036CC1D	[J3]12V out of range
ErrorDescription0036CC1E	[J3]12V out of range
ErrorDescription0036CC1F	[J3]6V out of range
ErrorDescription0036CC21	[J3]6V out of range
ErrorDescription0036CC22	[J3]5V out of range
ErrorDescription0036CC23	[J3]5V out of range
ErrorDescription0036CC24	[J3]5V out of range
ErrorDescription0036CC25	[J3]5V out of range
ErrorDescription0036DD15	[J3]1.2V self check error
ErrorDescription0036DD16	[J3]3.3V self check error
ErrorDescription0036DD17	[J3]1.2V self check error
ErrorDescription0036DD18	[J3]48V self check error
ErrorDescription0036DD1A	[J3]48V self check error
ErrorDescription0036DD1B	[J3]12V self check error
ErrorDescription0036DD1C	[J3]6V self check error
ErrorDescription0036DD1D	[J3]1.9V self check error
ErrorDescription0036DD1E	[J3]Device temperature self check error
ErrorDescription0036DD1F	[J3]Device temperature self check error
ErrorDescription0036DD21	[J3]encoder 1 self check error
ErrorDescription0036DD22	[J3]encoder 2 self check error
ErrorDescription0036DD23	[J3]encoder 3 self check error
ErrorDescription0036DD24	[J3]3-phase current error

ErrorDescription0036DD25	[J3]3-phase current error
ErrorDescription0036DD26	[J3]3-phase current error
ErrorDescription0036DD27	[J3]3-phase current error
ErrorDescription0036DD28	[J3]encoder cross check error
ErrorDescription0036DD29	[J3]encoder 1 latch signal error
ErrorDescription0036DD2A	[J3]encoder 2 latch signal error
ErrorDescription0036DD2B	[J3]encoder 1 cross check error
ErrorDescription0036DD2C	[J3]encoder 2 cross check error
ErrorDescription0036DD2D	[J3]5V cross check error
ErrorDescription0036DD2E	[J3]5V cross check error
ErrorDescription0036EE11	[J3]Safety parameter timeout
ErrorDescription0036EE12	[J3]Invalid Safety parameter
ErrorDescription0036EE13	[J3]Encoder SSI read fail
ErrorDescription0036EE14	[J3]Safety parameter load fail
ErrorDescription0036EE15	[J3]Previous position mismatch
ErrorDescription0036EE16	[J3]Previous position mismatch
ErrorDescription0036EE17	[J3]Previous position mismatch
ErrorDescription0036EE18	[J3]Tmsafe command error
ErrorDescription0036EE19	[J3]Encoder init timeout
ErrorDescription0036EE1A	[J3]absolute position initialization timeout
ErrorDescription0036EE1B	[J3]Encoder SSI cross check fail
ErrorDescription0036F003	[J3]Previous position mismatch
ErrorDescription0036F004	[J3]Absolute position mismatch
ErrorDescription0036F005	[J3]Previous position read fail
ErrorDescription0036F00E	[J3]Fail to map 2-side encoder
ErrorDescription0036F01A	[J3]Fail to map 2-side encoder
ErrorDescription0046AA11	[J4]RAM M0 march error
ErrorDescription0046AA12	[J4]RAM M1 march error
ErrorDescription0046AA13	[J4]RAM LS0 march error
ErrorDescription0046AA14	[J4]RAM LS1 march error
ErrorDescription0046AA15	[J4]RAM LS2 march error
ErrorDescription0046AA16	[J4]RAM LS3 march error
ErrorDescription0046AA17	[J4]RAM LS4 march error
ErrorDescription0046AA18	[J4]RAM LS5 march error
ErrorDescription0046AA19	[J4]RAM LS6 march error
ErrorDescription0046AA1A	[J4]RAM LS7 march error
ErrorDescription0046AA1B	[J4]RAM GS0-1 march error
ErrorDescription0046AA1C	[J4]RAM GS0-2 march error
ErrorDescription0046AA1D	[J4]RAM GS1-1 march error
ErrorDescription0046AA1E	[J4]RAM GS1-2 march error
ErrorDescription0046AA1F	[J4]RAM GS2-1 march error
ErrorDescription0046AA21	[J4]RAM GS2-2 march error
ErrorDescription0046AA22	[J4]RAM GS3-1 march error
ErrorDescription0046AA23	[J4]RAM GS3-2 march error
ErrorDescription0046AA24	[J4]SWBIST error
ErrorDescription0046AA25	[J4]SWBIST error
ErrorDescription0046AA2C	[J4]HWBIST error

ErrorDescription0046AA2E	[J4]Flash ECC error
ErrorDescription0046AA2F	[J4]Flash CRC error
ErrorDescription0046AA33	[J4]Watchdog timeout
ErrorDescription0046AA34	[J4]Sync step timeout
ErrorDescription0046AA35	[J4]Sync step timeout
ErrorDescription0046AA36	[J4]Sync step timeout
ErrorDescription0046AA37	[J4]Wrong Logic ID detected
ErrorDescription0046AA38	[J4]Timer0 INT out of range
ErrorDescription0046AA39	[J4]Timer0 INT out of range
ErrorDescription0046AA3A	[J4]Timer1 INT out of range
ErrorDescription0046AA3B	[J4]Timer1 INT out of range
ErrorDescription0046AA3C	[J4]Async digital input
ErrorDescription0046BB11	[J4]Cross check timeout
ErrorDescription0046BB12	[J4]Cross check timeout
ErrorDescription0046BB13	[J4]Cross check timeout
ErrorDescription0046BB14	[J4]Cross check timeout
ErrorDescription0046BB15	[J4]Cross check timeout
ErrorDescription0046BB16	[J4]Cross check timeout
ErrorDescription0046BB17	[J4]CRC cross check error
ErrorDescription0046BB18	[J4]CRC cross check error
ErrorDescription0046BB19	[J4]Cross check timeout
ErrorDescription0046BB1A	[J4]Tmsafe frame error
ErrorDescription0046BB1B	[J4]Tmsafe slave ID error
ErrorDescription0046BB1C	[J4]ADC cross check error
ErrorDescription0046BB1D	[J4]ADC cross check error
ErrorDescription0046BB1E	[J4]QEP cross check error
ErrorDescription0046BB1F	[J4]SL version mismatch
ErrorDescription0046CC11	[J4]1.2V out of range
ErrorDescription0046CC12	[J4]1.2V out of range
ErrorDescription0046CC13	[J4]3.3V out of range
ErrorDescription0046CC14	[J4]3.3V out of range
ErrorDescription0046CC15	[J4]1.2V out of range
ErrorDescription0046CC16	[J4]1.2V out of range
ErrorDescription0046CC17	[J4]3.3V out of range
ErrorDescription0046CC18	[J4]48V out of range
ErrorDescription0046CC1B	[J4]48V out of range
ErrorDescription0046CC1C	[J4]48V out of range
ErrorDescription0046CC1D	[J4]12V out of range
ErrorDescription0046CC1E	[J4]12V out of range
ErrorDescription0046CC1F	[J4]6V out of range
ErrorDescription0046CC21	[J4]6V out of range
ErrorDescription0046CC22	[J4]5V out of range
ErrorDescription0046CC23	[J4]5V out of range
ErrorDescription0046CC24	[J4]5V out of range
ErrorDescription0046CC25	[J4]5V out of range
ErrorDescription0046DD15	[J4]1.2V self check error
ErrorDescription0046DD16	[J4]3.3V self check error

ErrorDescription0046DD17	[J4]1.2V self check error
ErrorDescription0046DD18	[J4]48V self check error
ErrorDescription0046DD1A	[J4]48V self check error
ErrorDescription0046DD1B	[J4]12V self check error
ErrorDescription0046DD1C	[J4]6V self check error
ErrorDescription0046DD1D	[J4]1.9V self check error
ErrorDescription0046DD1E	[J4]Device temperature self check error
ErrorDescription0046DD1F	[J4]Device temperature self check error
ErrorDescription0046DD21	[J4]encoder 1 self check error
ErrorDescription0046DD22	[J4]encoder 2 self check error
ErrorDescription0046DD23	[J4]encoder 3 self check error
ErrorDescription0046DD24	[J4]3-phase current error
ErrorDescription0046DD25	[J4]3-phase current error
ErrorDescription0046DD26	[J4]3-phase current error
ErrorDescription0046DD27	[J4]3-phase current error
ErrorDescription0046DD28	[J4]encoder cross check error
ErrorDescription0046DD29	[J4]encoder 1 latch signal error
ErrorDescription0046DD2A	[J4]encoder 2 latch signal error
ErrorDescription0046DD2B	[J4]encoder 1 cross check error
ErrorDescription0046DD2C	[J4]encoder 2 cross check error
ErrorDescription0046DD2D	[J4]5V cross check error
ErrorDescription0046DD2E	[J4]5V cross check error
ErrorDescription0046EE11	[J4]Safety parameter timeout
ErrorDescription0046EE12	[J4]Invalid Safety parameter
ErrorDescription0046EE13	[J4]Encoder SSI read fail
ErrorDescription0046EE14	[J4]Safety parameter load fail
ErrorDescription0046EE15	[J4]Previous position mismatch
ErrorDescription0046EE16	[J4]Previous position mismatch
ErrorDescription0046EE17	[J4]Previous position mismatch
ErrorDescription0046EE18	[J4]Tmsafe command error
ErrorDescription0046EE19	[J4]Encoder init timeout
ErrorDescription0046EE1A	[J4]absolute position initialization timeout
ErrorDescription0046EE1B	[J4]Encoder SSI cross check fail
ErrorDescription0046F003	[J4]Previous position mismatch
ErrorDescription0046F004	[J4]Absolute position mismatch
ErrorDescription0046F005	[J4]Previous position read fail
ErrorDescription0046F00E	[J4]Fail to map 2-side encoder
ErrorDescription0046F01A	[J4]Fail to map 2-side encoder
ErrorDescription0056AA11	[J5]RAM M0 march error
ErrorDescription0056AA12	[J5]RAM M1 march error
ErrorDescription0056AA13	[J5]RAM LS0 march error
ErrorDescription0056AA14	[J5]RAM LS1 march error
ErrorDescription0056AA15	[J5]RAM LS2 march error
ErrorDescription0056AA16	[J5]RAM LS3 march error
ErrorDescription0056AA17	[J5]RAM LS4 march error
ErrorDescription0056AA18	[J5]RAM LS5 march error
ErrorDescription0056AA19	[J5]RAM LS6 march error

ErrorDescription0056AA1A	[J5]RAM LS7 march error
ErrorDescription0056AA1B	[J5]RAM GS0-1 march error
ErrorDescription0056AA1C	[J5]RAM GS0-2 march error
ErrorDescription0056AA1D	[J5]RAM GS1-1 march error
ErrorDescription0056AA1E	[J5]RAM GS1-2 march error
ErrorDescription0056AA1F	[J5]RAM GS2-1 march error
ErrorDescription0056AA21	[J5]RAM GS2-2 march error
ErrorDescription0056AA22	[J5]RAM GS3-1 march error
ErrorDescription0056AA23	[J5]RAM GS3-2 march error
ErrorDescription0056AA24	[J5]SWBIST error
ErrorDescription0056AA25	[J5]SWBIST error
ErrorDescription0056AA2C	[J5]HWBIST error
ErrorDescription0056AA2E	[J5]Flash ECC error
ErrorDescription0056AA2F	[J5]Flash CRC error
ErrorDescription0056AA33	[J5]Watchdog timeout
ErrorDescription0056AA34	[J5]Sync step timeout
ErrorDescription0056AA35	[J5]Sync step timeout
ErrorDescription0056AA36	[J5]Sync step timeout
ErrorDescription0056AA37	[J5]Wrong Logic ID detected
ErrorDescription0056AA38	[J5]Timer0 INT out of range
ErrorDescription0056AA39	[J5]Timer0 INT out of range
ErrorDescription0056AA3A	[J5]Timer1 INT out of range
ErrorDescription0056AA3B	[J5]Timer1 INT out of range
ErrorDescription0056AA3C	[J5]Async digital input
ErrorDescription0056BB11	[J5]Cross check timeout
ErrorDescription0056BB12	[J5]Cross check timeout
ErrorDescription0056BB13	[J5]Cross check timeout
ErrorDescription0056BB14	[J5]Cross check timeout
ErrorDescription0056BB15	[J5]Cross check timeout
ErrorDescription0056BB16	[J5]Cross check timeout
ErrorDescription0056BB17	[J5]CRC cross check error
ErrorDescription0056BB18	[J5]CRC cross check error
ErrorDescription0056BB19	[J5]Cross check timeout
ErrorDescription0056BB1A	[J5]Tmsafe frame error
ErrorDescription0056BB1B	[J5]Tmsafe slave ID error
ErrorDescription0056BB1C	[J5]ADC cross check error
ErrorDescription0056BB1D	[J5]ADC cross check error
ErrorDescription0056BB1E	[J5]QEP cross check error
ErrorDescription0056BB1F	[J5]SL version mismatch
ErrorDescription0056CC11	[J5]1.2V out of range
ErrorDescription0056CC12	[J5]1.2V out of range
ErrorDescription0056CC13	[J5]3.3V out of range
ErrorDescription0056CC14	[J5]3.3V out of range
ErrorDescription0056CC15	[J5]1.2V out of range
ErrorDescription0056CC16	[J5]1.2V out of range
ErrorDescription0056CC17	[J5]3.3V out of range
ErrorDescription0056CC18	[J5]48V out of range

ErrorDescription0056CC1B	[J5]48V out of range
ErrorDescription0056CC1C	[J5]48V out of range
ErrorDescription0056CC1D	[J5]12V out of range
ErrorDescription0056CC1E	[J5]12V out of range
ErrorDescription0056CC1F	[J5]6V out of range
ErrorDescription0056CC21	[J5]6V out of range
ErrorDescription0056CC22	[J5]5V out of range
ErrorDescription0056CC23	[J5]5V out of range
ErrorDescription0056CC24	[J5]5V out of range
ErrorDescription0056CC25	[J5]5V out of range
ErrorDescription0056DD15	[J5]1.2V self check error
ErrorDescription0056DD16	[J5]3.3V self check error
ErrorDescription0056DD17	[J5]1.2V self check error
ErrorDescription0056DD18	[J5]48V self check error
ErrorDescription0056DD1A	[J5]48V self check error
ErrorDescription0056DD1B	[J5]12V self check error
ErrorDescription0056DD1C	[J5]6V self check error
ErrorDescription0056DD1D	[J5]1.9V self check error
ErrorDescription0056DD1E	[J5]Device temperature self check error
ErrorDescription0056DD1F	[J5]Device temperature self check error
ErrorDescription0056DD21	[J5]encoder 1 self check error
ErrorDescription0056DD22	[J5]encoder 2 self check error
ErrorDescription0056DD23	[J5]encoder 3 self check error
ErrorDescription0056DD24	[J5]3-phase current error
ErrorDescription0056DD25	[J5]3-phase current error
ErrorDescription0056DD26	[J5]3-phase current error
ErrorDescription0056DD27	[J5]3-phase current error
ErrorDescription0056DD28	[J5]encoder cross check error
ErrorDescription0056DD29	[J5]encoder 1 latch signal error
ErrorDescription0056DD2A	[J5]encoder 2 latch signal error
ErrorDescription0056DD2B	[J5]encoder 1 cross check error
ErrorDescription0056DD2C	[J5]encoder 2 cross check error
ErrorDescription0056DD2D	[J5]5V cross check error
ErrorDescription0056DD2E	[J5]5V cross check error
ErrorDescription0056EE11	[J5]Safety parameter timeout
ErrorDescription0056EE12	[J5]Invalid Safety parameter
ErrorDescription0056EE13	[J5]Encoder SSI read fail
ErrorDescription0056EE14	[J5]Safety parameter load fail
ErrorDescription0056EE15	[J5]Previous position mismatch
ErrorDescription0056EE16	[J5]Previous position mismatch
ErrorDescription0056EE17	[J5]Previous position mismatch
ErrorDescription0056EE18	[J5]Tmsafe command error
ErrorDescription0056EE19	[J5]Encoder init timeout
ErrorDescription0056EE1A	[J5]absolute position initialization timeout
ErrorDescription0056EE1B	[J5]Encoder SSI cross check fail
ErrorDescription0056F003	[J5]Previous position mismatch
ErrorDescription0056F004	[J5]Absolute position mismatch

ErrorDescription0056F005	[J5]Previous position read fail
ErrorDescription0056F00E	[J5]Fail to map 2-side encoder
ErrorDescription0056F01A	[J5]Fail to map 2-side encoder
ErrorDescription0066AA11	[J6]RAM M0 march error
ErrorDescription0066AA12	[J6]RAM M1 march error
ErrorDescription0066AA13	[J6]RAM LS0 march error
ErrorDescription0066AA14	[J6]RAM LS1 march error
ErrorDescription0066AA15	[J6]RAM LS2 march error
ErrorDescription0066AA16	[J6]RAM LS3 march error
ErrorDescription0066AA17	[J6]RAM LS4 march error
ErrorDescription0066AA18	[J6]RAM LS5 march error
ErrorDescription0066AA19	[J6]RAM LS6 march error
ErrorDescription0066AA1A	[J6]RAM LS7 march error
ErrorDescription0066AA1B	[J6]RAM GS0-1 march error
ErrorDescription0066AA1C	[J6]RAM GS0-2 march error
ErrorDescription0066AA1D	[J6]RAM GS1-1 march error
ErrorDescription0066AA1E	[J6]RAM GS1-2 march error
ErrorDescription0066AA1F	[J6]RAM GS2-1 march error
ErrorDescription0066AA21	[J6]RAM GS2-2 march error
ErrorDescription0066AA22	[J6]RAM GS3-1 march error
ErrorDescription0066AA23	[J6]RAM GS3-2 march error
ErrorDescription0066AA24	[J6]SWBIST error
ErrorDescription0066AA25	[J6]SWBIST error
ErrorDescription0066AA2C	[J6]HWBIST error
ErrorDescription0066AA2E	[J6]Flash ECC error
ErrorDescription0066AA2F	[J6]Flash CRC error
ErrorDescription0066AA33	[J6]Watchdog timeout
ErrorDescription0066AA34	[J6]Sync step timeout
ErrorDescription0066AA35	[J6]Sync step timeout
ErrorDescription0066AA36	[J6]Sync step timeout
ErrorDescription0066AA37	[J6]Wrong Logic ID detected
ErrorDescription0066AA38	[J6]Timer0 INT out of range
ErrorDescription0066AA39	[J6]Timer0 INT out of range
ErrorDescription0066AA3A	[J6]Timer1 INT out of range
ErrorDescription0066AA3B	[J6]Timer1 INT out of range
ErrorDescription0066AA3C	[J6]Async digital input
ErrorDescription0066BB11	[J6]Cross check timeout
ErrorDescription0066BB12	[J6]Cross check timeout
ErrorDescription0066BB13	[J6]Cross check timeout
ErrorDescription0066BB14	[J6]Cross check timeout
ErrorDescription0066BB15	[J6]Cross check timeout
ErrorDescription0066BB16	[J6]Cross check timeout
ErrorDescription0066BB17	[J6]CRC cross check error
ErrorDescription0066BB18	[J6]CRC cross check error
ErrorDescription0066BB19	[J6]Cross check timeout
ErrorDescription0066BB1A	[J6]Tmsafe frame error
ErrorDescription0066BB1B	[J6]Tmsafe slave ID error



ErrorDescription0066BB1C	[J6]ADC cross check error
ErrorDescription0066BB1D	[J6]ADC cross check error
ErrorDescription0066BB1E	[J6]QEP cross check error
ErrorDescription0066BB1F	[J6]SL version mismatch
ErrorDescription0066CC11	[J6]1.2V out of range
ErrorDescription0066CC12	[J6]1.2V out of range
ErrorDescription0066CC13	[J6]3.3V out of range
ErrorDescription0066CC14	[J6]3.3V out of range
ErrorDescription0066CC15	[J6]1.2V out of range
ErrorDescription0066CC16	[J6]1.2V out of range
ErrorDescription0066CC17	[J6]3.3V out of range
ErrorDescription0066CC18	[J6]48V out of range
ErrorDescription0066CC1B	[J6]48V out of range
ErrorDescription0066CC1C	[J6]48V out of range
ErrorDescription0066CC1D	[J6]12V out of range
ErrorDescription0066CC1E	[J6]12V out of range
ErrorDescription0066CC1F	[J6]6V out of range
ErrorDescription0066CC21	[J6]6V out of range
ErrorDescription0066CC22	[J6]5V out of range
ErrorDescription0066CC23	[J6]5V out of range
ErrorDescription0066CC24	[J6]5V out of range
ErrorDescription0066CC25	[J6]5V out of range
ErrorDescription0066DD15	[J6]1.2V self check error
ErrorDescription0066DD16	[J6]3.3V self check error
ErrorDescription0066DD17	[J6]1.2V self check error
ErrorDescription0066DD18	[J6]48V self check error
ErrorDescription0066DD1A	[J6]48V self check error
ErrorDescription0066DD1B	[J6]12V self check error
ErrorDescription0066DD1C	[J6]6V self check error
ErrorDescription0066DD1D	[J6]1.9V self check error
ErrorDescription0066DD1E	[J6]Device temperature self check error
ErrorDescription0066DD1F	[J6]Device temperature self check error
ErrorDescription0066DD21	[J6]encoder 1 self check error
ErrorDescription0066DD22	[J6]encoder 2 self check error
ErrorDescription0066DD23	[J6]encoder 3 self check error
ErrorDescription0066DD24	[J6]3-phase current error
ErrorDescription0066DD25	[J6]3-phase current error
ErrorDescription0066DD26	[J6]3-phase current error
ErrorDescription0066DD27	[J6]3-phase current error
ErrorDescription0066DD28	[J6]encoder cross check error
ErrorDescription0066DD29	[J6]encoder 1 latch signal error
ErrorDescription0066DD2A	[J6]encoder 2 latch signal error
ErrorDescription0066DD2B	[J6]encoder 1 cross check error
ErrorDescription0066DD2C	[J6]encoder 2 cross check error
ErrorDescription0066DD2D	[J6]5V cross check error
ErrorDescription0066DD2E	[J6]5V cross check error
ErrorDescription0066EE11	[J6]Safety parameter timeout



ErrorDescription0066EE12	[J6]Invalid Safety parameter
ErrorDescription0066EE13	[J6]Encoder SSI read fail
ErrorDescription0066EE14	[J6]Safety parameter load fail
ErrorDescription0066EE15	[J6]Previous position mismatch
ErrorDescription0066EE16	[J6]Previous position mismatch
ErrorDescription0066EE17	[J6]Previous position mismatch
ErrorDescription0066EE18	[J6]Tmsafe command error
ErrorDescription0066EE19	[J6]Encoder init timeout
ErrorDescription0066EE1A	[J6]absolute position initialization timeout
ErrorDescription0066EE1B	[J6]Encoder SSI cross check fail
ErrorDescription0066F003	[J6]Previous position mismatch
ErrorDescription0066F004	[J6]Absolute position mismatch
ErrorDescription0066F005	[J6]Previous position read fail
ErrorDescription0066F00E	[J6]Fail to map 2-side encoder
ErrorDescription0066F01A	[J6]Fail to map 2-side encoder
ErrorSuggestion00000001	<p>[Cause] Motion assigned is invalid, mostly because of over working range</p> <p>[Caution]</p> <ol style="list-style-type: none"> <li>1. Check if the robot is under Singularity</li> <li>2. Check if the motion assigned in MOVE node is out of specification</li> </ol> <p>[Additional Explanation] This error is not likely happens, instead, the system will report error code 0x00000009</p> <p>[Additional Explanation] If the settings of MOVE node is out of specification, such as, moving along X axis by 99999 mm</p> <p>[Additional Explanation] If the motion assigned is sure to be correct but with this error occurs, contact and report to Techman Robot Inc.</p> <p>[Solution]</p> <p>To restore the robot from error status:</p> <ol style="list-style-type: none"> <li>1. Trigger Robot Stick Reset button or user connected Reset input to back to normal operation.</li> </ol> <p>Adjust the motion related nodes in the current project:</p> <ol style="list-style-type: none"> <li>1. Make sure the points used in a Project would not lead to any Singularity</li> <li>2. Make sure the motion (distance, rotation) assigned in move is available</li> </ol>
ErrorSuggestion00000005	<p>[Cause] Receive Stop Motion Command</p> <p>[Solution]</p> <p>Clear this error and keep on going</p>
ErrorSuggestion00000008	<p>[Cause] Motion assigned is invalid</p> <p>[Caution]</p> <ol style="list-style-type: none"> <li>1. Check if the robot is under Singularity</li> <li>2. Check if the motion assigned in MOVE node is out of specification</li> </ol> <p>[Additional Explanation] If the settings of MOVE node is out of specification, such as, moving along X axis by 99999 mm</p> <p>[Additional Explanation] If the motion assigned is sure to be correct but with this error occurs, contact and report to Techman Robot Inc.</p> <p>[Solution]</p> <p>To restore the robot from error status:</p> <ol style="list-style-type: none"> <li>1. Trigger Robot Stick Reset button or user connected Reset input to back to normal operation.</li> </ol> <p>Adjust the motion related nodes in the current project:</p> <ol style="list-style-type: none"> <li>1. Make sure the points used in a Project would not lead to any Singularity</li> <li>2. Make sure the motion (distance, rotation) assigned in move is available</li> </ol>

ErrorSuggestion00000009

[Cause] Motion assigned is invalid

[Caution]

1. Check if the robot is under Singularity
2. Check if the motion assigned in MOVE node is out of specification

[Additional Explanation] If the settings of MOVE node is out of specification, such as, moving along X axis by 99999 mm

[Additional Explanation] If the motion assigned is sure to be correct but with this error occurs, contact and report to Techman Robot Inc.

[Solution]

To restore the robot from error status:

1. Trigger Robot Stick Reset button or user connected Reset input to back to normal operation.

Adjust the motion related nodes in the current project:

1. Make sure the points used in a Project would not lead to any Singularity
2. Make sure the motion (distance, rotation) assigned in move is available

ErrorSuggestion0000000A

[Cause]

1. 3 points which build a coordinate frame are on the same line
2. Motion path set at the position that Robot arm cannot reach.
3. End point set at the singularity.

[Caution]

1. Check if the custom base is set properly
2. Check if the path used is reachable or not

[Precaution] Improper custom base or path might lead to unexpected risk to safety

[Solution]

1. Trigger Robot Stick Reset button or user connected Reset input to back to normal operation.
2. Correct the invalid settings
3. If this problem still occurs, contact a qualified service engineer for further analysis with log files
4. Make sure that these 3 points which build a coordinate frame were not on the same line or adjust the flow to let motion path in the working range and away from the singularity

ErrorSuggestion0000000B

[Cause]

1. The direction of trajectory movement is parallel or nearly parallel to the direction of TCP tool-z
2. Trajectory movement is static or fixed-point movement

[Caution]

1. Check if the direction of trajectory movement in F/T Subflow is parallel or nearly parallel to the direction of TCP tool-z
2. Check if the direction of trajectory movement in F/T Subflow is static or fixed-point movement

[Solution]

1. Trigger Robot Stick Reset button or user connected Reset input to back to normal operation
2. Make sure that trajectory movement is not static and fixed-point movement
3. Adjust the trajectory in F/T Subflow so that the direction of movement is not parallel and nearly parallel to the direction of TCP tool-z
4. Either adjust the posture of TCP to so that the direction of tool-z is not parallel and nearly parallel to the direction of trajectory movement in F/T Subflow
5. To maintain the same TCP posture and trajectory movement in F/T Subflow, adjust the posture setting of TCP relative to robot end flange so that the direction of TCP tool-z is not parallel and nearly parallel to the direction of trajectory movement in F/T Subflow
6. Either choose tool or point as the reference coordinate system

ErrorSuggestion00000010	[Cause] Tool Connected Failure With Robot [Solution] Please make sure that motion path is in the working range and the path is far away from the singularity
ErrorSuggestion00000011	[Cause] Inverse Kinematics Failure, Motion Blending Issue [Solution] Please make sure that motion path is in the working range and the path is far away from the singularity
ErrorSuggestion00000012	[Cause] Motion assigned is invalid, mostly because of singularity [Caution] 1. Check if the robot is under Singularity 2. Check if the motion assigned in MOVE node may lead to any singularity [Additional Explanation] This error is not likely happens, instead, the system will report error code 0x00000009 [Additional Explanation] If the motion assigned is sure to be correct but with this error occurs, contact and report to Techman Robot Inc. [Solution] To restore the robot from error status: 1. Trigger Robot Stick Reset button or user connected Reset input to back to normal operation. Adjust the motion related nodes in the current project: 1. Make sure the points used in a Project would not lead to any singularity 2. Make sure the motion (distance, rotation) assigned in move is available
ErrorSuggestion00000013	Please contact the original purchase of the manufacturer or a third party designated maintenance unit.
ErrorSuggestion00000014	[Cause] The current approaching action requires a huge variation of joint angles which is over the ability that the motors can do in a single servo command [Caution] 1. Check if the current posture or the destination point is near a singularity point. 2. Check if the motion path would likely pass through a internal singularity point. 3. Check if the project speed or speed settings of the points are too fast. [Additional Explanation] If the robot moves under the circumstances of singularity (both internal and external) with LINE on motion setting, that may easily cause this error. 1. Avoid postures or motion paths near singularities. 2. Decrease speed If you want to keep the posture or motion path smooth. [Solution] To restore the robot from error status: 1. Trigger Robot Stick Reset button or user connected Reset input to back to normal operation.
ErrorSuggestion00000015	Please make sure that these 3 points which build the circular path are not on the line.
ErrorSuggestion00000016	Please contact the original purchase of the manufacturer or a third party designated maintenance unit.
ErrorSuggestion00000017	Please contact the original purchase of the manufacturer or a third party designated maintenance unit.
ErrorSuggestion00000018	Please make sure that motion path is in the working range and the path is far away from the singularity
ErrorSuggestion00000019	[Cause] Robot cannot be stop at the assigned point position with Precise positioning option is checked. [Caution] [Additional Explanations] Since the joint driver cannot move to the assigned point position successfully, it would cause this error. [Solution(End User)] Check if this error is easily triggered at a specific point. If yes, please modify the project to avoid this specific point. [Solution(Robot Maintenance Staff)] Follow Troubleshooting Guide "Joints error" for troubleshooting.

ErrorSuggestion0000001A	<p>[Cause] Robot detects the LINE motion cannot be executed successfully</p> <p>[Caution] Check if the motion is LINE while the blending radius is set to 0</p> <p>[Additional Explanations] Robot detects the user input the invalid values in the By Radius settings which cannot be executed successfully.</p> <p>[Additional Explanation] This could probably happens on POINT or MOVE node</p> <p>[Solution]</p> <p>To restore the robot from error status:</p> <ol style="list-style-type: none"> <li>1. Trigger Robot Stick Reset button or user connected Reset input to back to normal operation.</li> <li>2. Before running project, check if there is any motion related nodes set to be LINE while the blending radius is set to 0</li> </ol>
ErrorSuggestion0000001B	<p>[Cause] Target of Line Motion is Out of reachable point of Robot</p> <p>[Solution] Check if Target Point of Line Motion is reasonable</p>
ErrorSuggestion0000001C	<p>[Cause] Target of PtP Motion is Out of Joint Boundary</p> <p>[Solution] Check if Target Point of PtP Motion is reasonable</p>
ErrorSuggestion00000021	<p>[Cause] The robot detected an exceeding TCP speed or Joint speed which is over the limit of the Safety Settings</p> <p>[Caution]</p> <ol style="list-style-type: none"> <li>1. Check and make sure the TCP speed limit or Joint speed limit on Settings\Safety Settings\Safety Stop Criteria is suitable.</li> <li>2. Check and make sure the TCP speed limit or Joint speed limit on, Settings\Safety Settings\Collaborative Setting\More Limit Setting, is suitable for Collaborative Mode</li> <li>3. Make sure the settings of TCP used are correct, especially the Pose of TCP.</li> <li>4. Check if the issued point is PTP on motion setting.</li> <li>5. Check if the issued point is LINE on motion setting(ABS).</li> </ol> <p>[Precaution] This error message would only show in the servo log and would be read by system's voice. It will not be displayed in a HMI error window.</p> <p>[Additional Explanation]</p> <p>If the robot moves under the circumstances of singularity (both internal and external) with PTP on motion setting, that may easily cause this error.</p> <ol style="list-style-type: none"> <li>1. Avoid postures or motion paths near singularities.</li> <li>2. Decrease the speed If you want to keep the posture or motion path smooth.</li> <li>3. Make sure the speed limit values of the Safety Settings are suitable in both Manual/Auto Mode and collaborative work space.</li> </ol> <p>[Solution]</p> <p>To restore the robot from error status:</p> <ol style="list-style-type: none"> <li>1. Trigger Robot Stick Reset button or user connected Reset input to back to normal operation.</li> </ol>
ErrorSuggestion00000022	<p>[Cause] The robot detected an exceeding TCP force or Joint torque which is over the limit of the Safety Setting</p> <p>[Caution]</p> <ol style="list-style-type: none"> <li>1. Check if the robot collides with anything.</li> <li>2. Check and make sure the TCP force limit is suitable.</li> <li>3. Make sure the settings of all TCP/Joint torque used are correct including the pose of TCP, Mass, Mass Center Frame and Principal Moments of Inertia.</li> <li>4. Make sure the payload setting is correct on every motion related node of the flow, e.g. Point, Move, Pallet, etc.</li> <li>5. Make sure there are no sudden pauses/stops in the project while the robot is moving at high speed.</li> </ol> <p>[Precaution] Tool with Mass Center Frame far from the flange will add heavy external torque onto the robot. Without the correct TCP settings (including, TCP pose, Mass, Mass Center Frame and Principal Moments of Inertia), the Servo System would likely mistake this for a error.</p> <p>[Additional Explanation]</p>

ErrorSuggestion00000023	<p>The result of TCP force is achieved by calculation. This calculation will be dysfunctional when the robot passes through a singularity zone, and could mistakenly trigger this error.</p> <ol style="list-style-type: none"> <li>1. Avoid postures or motion paths near singularities.</li> <li>2. Decrease the speed If you want to keep the posture or motion path smooth.</li> <li>3. Make sure the speed limit values of the Safety Settings are suitable in both Manual/Auto Mode and collaborative work space.</li> </ol> <p>[Solution]</p> <p>To restore the robot from error status:</p> <ol style="list-style-type: none"> <li>1. Trigger Robot Stick Reset button or user connected Reset input to back to normal operation.</li> </ol> <p>[Cause] TCP speed and force are both over limit at the same time</p> <p>[Caution]</p> <ol style="list-style-type: none"> <li>1. Check if the robot has been moving too fast currently</li> <li>2. Check if the robot has collided to anything</li> </ol> <p>[Additional Explanation] This error code is not likely happen, low possibility, since it always trigger either 0x21 or 0x22 at the first place</p> <p>[Precaution]</p> <p>Assess if it is necessary to drag the robot to a safer space by safe startup mode</p> <ol style="list-style-type: none"> <li>1. Make sure the speed of the current is within specification</li> <li>2. Make sure the robot would not collide with the surroundings during project run</li> </ol>
ErrorSuggestion00000024	<p>[Solution]</p> <p>To restore the robot from error status:</p> <ol style="list-style-type: none"> <li>1. Trigger Robot Stick Reset button or user connected Reset input to back to normal operation.</li> <li>2. Reduce the payload or the motion speed.</li> <li>3. Revise the safety criteria.</li> </ol> <p>[Cause] The robot detected an intense shake.</p> <p>[Caution]</p> <ol style="list-style-type: none"> <li>1. Check if the robot collided with anything in Collaborative Mode.</li> <li>2. Check the robot stability while the project is running.</li> </ol> <p>[Precaution] The environment or location of the robot should be stable.</p> <p>[Solution]</p> <ol style="list-style-type: none"> <li>1. Ensure that the robot's posture, location and motion does not collide with anything.</li> <li>2. Move or place the robot in a location where it is stable while a project is running.</li> </ol>
ErrorSuggestion00000028	<p>Please reboot the robot. If the error still occurs, please contact the original purchase of the manufacturer or a third party designated maintenance unit.</p>
ErrorSuggestion0000002D	<p>[Cause] joint type is not match the product of the vendor.</p>
ErrorSuggestion0000002E	<p>gear ratio is not match the model</p>
ErrorSuggestion0000002F	<p>Please reboot the robot. If the error still occurs, please contact the original purchase of the manufacturer or a third party designated maintenance unit.</p>
ErrorSuggestion00000030	<p>[Cause] I/O Board's current over the spec range(1.5A).</p> <p>[Caution]</p> <p>[Additional Explanations] If the external devices are abnormal that cause current are too large, it would cause this error.</p> <p>[Solution]</p> <ol style="list-style-type: none"> <li>1. Remove all external devices first</li> <li>2. After restart the robot, the problem still occurs, contact a qualified service engineer for further analysis</li> <li>3. Make sure all external device will not consumed over 1.5A from Control box IO</li> </ol>

ErrorSuggestion00000031	Please reboot the robot. If the error still occurs, please contact the original purchase of the manufacturer or a third party designated maintenance unit.
ErrorSuggestion00000032	Please reboot the robot. If the error still occurs, please contact the original purchase of the manufacturer or a third party designated maintenance unit.
ErrorSuggestion00000033	[Cause] The TCP speed is too high and over the limit during any operation under Manual Mode [Caution] 1. Check speed limit in Safety Settings. 2. Check if the TCP position settings from the flange. [Additional Explanation] This error is not likely happen, usually, other error safety related error code might be triggered first 1. Make sure the safety settings is suitable. 2. Make sure any motion related operation (Hand-guiding, Step-run, Controller) moves within the limits. [Solution] To restore the robot from error status: 1. Trigger Robot Stick Reset button or user connected Reset input to back to normal operation. 2. Adjust the TCP settings and the Safety Settings. 3. Decrease the setting of the speed and the setting of the angular velocity under the Manual Mode.
ErrorSuggestion00000034	Please reboot the robot. If the error still occurs, please contact the original purchase of the manufacturer or a third party designated maintenance unit.
ErrorSuggestion00000035	[Cause] System has detected an error on joint driver [Caution] Check the other error code come along with it. [Additional Explanation] If there is any joint's driver component error occur.it world all report this error code but user can check the next error code which along with this error to get the further information. [Solution] 1. Depend on the error code after this error, find the corresponding error code description in the error code table.
ErrorSuggestion00000036	Please reboot the robot. If the error still occurs, please contact the original purchase of the manufacturer or a third party designated maintenance unit.
ErrorSuggestion00000037	Please reboot the robot. If the error still occurs, please contact the original purchase of the manufacturer or a third party designated maintenance unit.
ErrorSuggestion00000038	Please reboot the robot. If the error still occurs, please contact the original purchase of the manufacturer or a third party designated maintenance unit.
ErrorSuggestion00000039	Please reboot the robot. If the error still occurs, please contact the original purchase of the manufacturer or a third party designated maintenance unit.
ErrorSuggestion0000003A	Please reboot the robot. If the error still occurs, please contact the original purchase of the manufacturer or a third party designated maintenance unit.
ErrorSuggestion0000003B	[Cause] The joint number is different from the joint number in setting [Caution] Check if any robot joint has been replaced recently [Additional Explanation] This often occurs if the robot joint(s) been replaced or fixed but without proper update on EEPROM [Solution] Contact a qualified service engineer for further analysis [Agent-only] Make sure EEPROM be updated after replacing a joint module or Power board
ErrorSuggestion0000003C	[Cause] EtherCAT connection failure during power on [Caution] 1. Check if the robot cable is connected or not 2. If the robot cable is well connected, have a qualified service engineer to check if the Ethernet cable between Power Control Board and IPC Board is connected properly [Restriction] Power off the system and also unplug the power cable before opening the control box

	<p>[Additional Explanation] This error would only happen during power on, and is shown on the HMI Error Page only. Pressing and releasing ESTOP too often might cause this error.</p> <p>[Solution(End User)]</p> <ol style="list-style-type: none"> <li>1. Power off the system first</li> <li>2. Check and confirm the corresponding wire/cable is connected properly</li> <li>3. Power on the system</li> <li>4. Before power on the system, you could double check robot cable is well connected to the Control Box</li> </ol> <p>[Solution(Robot Maintenance Staff)]</p> <ol style="list-style-type: none"> <li>1. Follow Troubleshooting Guide "Robot connection error" for troubleshooting.</li> <li>2. Follow Troubleshooting Guide "Robot voltage error" for troubleshooting.</li> </ol>
ErrorSuggestion0000003D	Please release the emergency button and reboot the robot. If the error still occurred, please contact the original purchase of the manufacturer or a third party designated maintenance unit.
ErrorSuggestion0000003E	<p>[Cause] The robot detected that voltage is over the specified range (43V~45V) in PreOP mode.</p> <p>[Caution]</p> <ol style="list-style-type: none"> <li>1. Power eater board malfunction.</li> <li>2. Power supply abnormal.</li> <li>3. Robot power cable short-circuited.</li> </ol> <p>[Additional Explanation] When a robot is equipped with a power eater board, a short circuit in the power supply or power cable would cause this error.</p> <p>[Additional Explanation] The threshold to trigger the PreOP error is lower than 40V(Electric motor),power eater board is lower than 36.</p> <p>[Solution(End User)]</p> <ol style="list-style-type: none"> <li>1. Perform the robot restart procedure.</li> <li>2. If a error still occurs after the restart, please contact a qualified service engineer for additional support.</li> <li>3. Ensure a secure connection at the power cable terminals.</li> </ol> <p>[Solution(Robot Maintenance Staff)]</p> <p>Check following status:</p> <ol style="list-style-type: none"> <li>1. Remove the Robot Cable and turn on control box, and check if voltage shown on LCM is between 46~48.</li> <li>2. Follow Troubleshooting Guide "Robot voltage error" for troubleshooting.</li> </ol>
ErrorSuggestion0000003F	N/a
ErrorSuggestion00000040	<p>[Cause]</p> <ol style="list-style-type: none"> <li>1. ESI returned unexpected data</li> <li>2. Joint PCB is abnormal</li> </ol> <p>[Additional Explanations] When Joint ESI does not match the default setting, it will report this error</p> <p>[Solution]</p> <p>After restart the robot, the problem still occurs, contact a qualified service engineer for further analysis with log files</p>
ErrorSuggestion00000041	<p>[Cause]</p> <ol style="list-style-type: none"> <li>1. EtherCAT related components are abnormal</li> <li>2. Joint PCB is abnormal</li> </ol> <p>[Additional Explanation] When Joint abnormal response SDO command, it will report this error</p> <p>[Solution]</p> <p>After restart the robot, the problem still occurs, contact a qualified service engineer for further analysis with log files</p>
ErrorSuggestion00000042	Please reboot the robot. If the error still occurs, please contact the original purchase of the manufacturer or a third party designated maintenance unit.
ErrorSuggestion00000043	<p>[Cause] TCP/IP stack abnormal.</p> <p>[Additional Explanation] This may happen if quality of the network is unstable</p> <p>[Solution]</p>



ErrorSuggestion00000044	<p>1. Make sure the network is stable</p> <p>2. After restart the robot, the problem still occurs, contact a qualified service engineer for further analysis with log files</p> <p>[Cause]</p> <p>1. EtherCAT related components are abnormal</p> <p>2. Joint PCB is abnormal</p> <p>[Additional Explanations] When failed to turn into DC SYNC in the EtherCAT loop, it will report this error</p> <p>[Solution]</p>
ErrorSuggestion00000045	<p>After restart the robot, the problem still occurs, contact a qualified service engineer for further analysis with log files</p> <p>Please reboot the robot. If the error still occurs, please contact the original purchase of the manufacturer or a third party designated maintenance unit.</p>
ErrorSuggestion00000046	<p>Please reboot the robot. If the error still occurs, please contact the original purchase of the manufacturer or a third party designated maintenance unit.</p>
ErrorSuggestion00000047	<p>Please reboot the robot. If the error still occurs, please contact the original purchase of the manufacturer or a third party designated maintenance unit.</p>
ErrorSuggestion00000048	<p>[Cause] The robot detect the voltage is over the spec(48V)range in ESM-OP mode</p> <p>[Additional Explanation] When robot has power supply or power cable short-circuited because of poor contact which would cause this error.</p> <p>[Additional Explanation] The threshold to trigger this error is power board's voltage lower than 48.</p> <p>[Solution]</p> <p>1. Make sure and regularly check if power cable are connected to the robot are firmed enough</p> <p>2. Before using robot, make sure the power supply is robust for robot running</p> <p>3. After restart the robot, the problem still occurs, contact a qualified service engineer for further analysis</p>
ErrorSuggestion00000049	<p>[Cause] Check the power supply is robust for robot running.</p> <p>[Additional Explanation] The threshold to trigger this error is power board's voltage lower than 48.</p> <p>[Solution]</p> <p>1. Before using robot, make sure the power supply is robust for robot running</p> <p>2. After restart the robot, the problem still occurs, contact a qualified service engineer for further analysis</p>
ErrorSuggestion0000004A	<p>Please reboot the robot. If the error still occurs, please contact the original purchase of the manufacturer or a third party designated maintenance unit.</p>
ErrorSuggestion0000004B	<p>[Cause] EtherCAT communication has been cut off while the robot is on</p> <p>[Caution] Check if there is any external EtherCAT devices, and if the Ethernet cable is loosen or if they are power off accidentally</p> <p>[Precaution] Power-off and unplug the power cable when checking inside the control box is necessary</p> <p>[Additional Explanation] This usually happens if any EtherCAT devices is cut off, for example, Ethernet cable is loosen or power-off accidentally</p> <p>[Additional Explanation]</p> <p>This may happens if the robot or control box has been placed on a unstable platform or having violent collision.</p> <p>1. Make sure all external EtherCAT devices are well connected and functional</p> <p>2. Make sure the robot would not be collided and be placed on a unstable platform</p> <p>[Solution(End User)]</p> <p>1. Shutdown the robot</p> <p>2. Restore the external EtherCAT devices and then reboot the robot</p> <p>3. If this still happens, contact a qualified service engineer for further analysis</p> <p>[Solution(Robot Maintenance Staff)]</p> <p>1. Follow Troubleshooting Guide "Robot connection error" for troubleshooting.</p> <p>2. Follow Troubleshooting Guide "Robot voltage error" for troubleshooting.</p>



ErrorSuggestion0000004C	<p>[Cause]</p> <ol style="list-style-type: none"> <li>1. EEPROM in Power Board is abnormal</li> <li>2. Power Board is abnormal</li> </ol> <p>[Additional Explanation] When failed to access EEPROM Data in the Power Board, it will report this error</p> <p>[Solution]</p> <p>Please help to unplug the stick cable from PCB and use the remote on/off to power on (please use TMflow power off function to shutdown system) the Control Box several times to see if the issue still there or not.</p> <p>After restart the robot, the problem still occurs, contact a qualified service engineer for further analysis</p>
ErrorSuggestion0000004D	<p>[Cause]</p> <ol style="list-style-type: none"> <li>1. EtherCAT related components are abnormal</li> <li>2. Joint PCB is abnormal</li> </ol> <p>[Additional Explanation] When failed to access live data from Joint, it will report this error</p> <p>[Solution]</p> <p>After restart the robot, the problem still occurs, contact a qualified service engineer for further analysis</p>
ErrorSuggestion0000004E	<p>[Cause] System has detected a mismatch of S/N between the robot and the control box</p> <p>[Caution] Check if the S/N (Serial Number) of the robot arm matches the one on the control box</p> <p>[Additional Explanation]</p> <p>If the S/Ns are correctly matched, there would other possibilities, such as:</p> <ol style="list-style-type: none"> <li>1. The Power Control Board is damaged</li> <li>2. The EEPROM is not updated correctly after replacing the Robot Joint or Power Control Board</li> </ol> <p>[Solution]</p> <ol style="list-style-type: none"> <li>1. Confirm and make sure the S/Ns are matched between the robot and the control box</li> <li>2. Else, contact a qualified service engineer for further analysis</li> <li>3. Before powering on the system, you could double check the connection about robot cable, and a suitable S/N match about robot arm and control box</li> <li>4. Service Engineers should follow the correct process when replacing the Robot Joints or Power Control Board</li> </ol>
ErrorSuggestion0000004F	<p>[Cause] The power control board is not detected during power on</p> <p>[Precaution] Power-off and unplug the power cable when checking inside the control box is necessary.</p> <p>[Additional Explanation] This usually happens if the control box has been placed on a unstable platform or having violent collision.</p> <p>[Additional Explanation] This error is less likely happens.</p> <p>[Solution(End User)]</p> <ol style="list-style-type: none"> <li>1. Turn off system power and check if every cable is connected rightly.</li> <li>2. Before turn on system power, please make sure to set robot on a stable platform, and check Robot Cable is connected toughly.</li> </ol> <p>[Solution(Robot Maintenance Staff)]</p> <ol style="list-style-type: none"> <li>1. Follow Troubleshooting Guide "Robot connection error" for troubleshooting.</li> <li>2. Follow Troubleshooting Guide "Robot voltage error" for troubleshooting.</li> </ol>
ErrorSuggestion00000050	<p>[Cause] The system could not detect the power control board, or the EtherCAT communication fails</p> <p>[Caution] Check if there is any external EtherCAT devices, and if the Ethernet cable is loosen or if they are power off accidentally</p> <p>[Precaution] Power-off and unplug the power cable when checking inside the control box is necessary</p> <p>[Additional Explanation] This usually happens if any EtherCAT devices is cut off, for example, Ethernet cable is loosen or power-off accidentally</p> <p>[Additional Explanation] This may happens if the robot or control box has been placed on a unstable platform or having violent collision.</p> <ol style="list-style-type: none"> <li>1. Make sure all external EtherCAT devices are well connected and functional</li> </ol>

ErrorSuggestion00000051	<p>2. Make sure the robot would not be collided and be placed on a unstable platform.</p> <p>[Solution(End User)]</p> <ol style="list-style-type: none"> <li>1. Shutdown the robot</li> <li>2. Restore the external EtherCAT devices and then reboot the robot</li> <li>3. If this still happens, contact a qualified service engineer for further analysis</li> </ol> <p>[Solution(Robot Maintenance Staff)]</p> <ol style="list-style-type: none"> <li>1. Follow Troubleshooting Guide "Robot connection error" for troubleshooting.</li> <li>2. Follow Troubleshooting Guide "Robot voltage error" for troubleshooting.</li> </ol> <p>[Cause] Power board's temperature is too high because of the environment is too hot or power board is abnormal.</p> <p>[Additional Explanation] The servo would trigger this error if the power board's temperature is higher than 80 °C.</p> <p>[Solution]</p> <ol style="list-style-type: none"> <li>1. Power off the robot and let it cool down for a while (suggest at least half a hour)</li> <li>2. Restart the robot, if the problem still occurs, contact a qualified service engineer for further analysis.</li> <li>3. Make sure the environment temperature is within the specification (0~50 °C) when robot is running.</li> </ol>
ErrorSuggestion00000052	<p>[Cause]</p> <ol style="list-style-type: none"> <li>1. ESTOP button on the Robot Stick has been pressed.</li> <li>2. The extension port(s) for ESTOP button has been triggered.</li> <li>3. The external safety device input discrepancy.</li> </ol> <p>[Caution]</p> <ol style="list-style-type: none"> <li>1. Check that the wire between the Robot Stick and the control box is securely connected and is not triggered.</li> <li>2. Check if the wire on the extension port(s) for ESTOP button is securely connected and is not triggered.</li> <li>3. Check if the wire on the external safety device port(s) is securely fastened.</li> </ol> <p>[Precaution]</p> <p>When the situation above is triggered, the robot will enter STO, which means the power is cut off after the robot speed has been decreased to zero. If there are any payloads on the TCP, without drive power, the TCP will tend to drop a little bit before coming to a complete stop. Please be aware of the tool (payload) colliding with objects in close proximity.</p> <ol style="list-style-type: none"> <li>1. Place the Robot Stick or the external ESTOP button in a location to make sure it is reachable while not being pressed accidentally.</li> <li>2. Check if the Robot Stick cable and the wire connected to the ESTOP ports are firmly connected.</li> <li>3. Ensure that all wires connected to the external safety device port(s) are securely connected.</li> </ol> <p>[Solution]</p> <ol style="list-style-type: none"> <li>1. If the ESTOP button on the Robot Stick has been pressed: <ol style="list-style-type: none"> <li>a. Release the ESTOP button.</li> <li>b. Trigger Robot Stick Reset button or user connected Reset input to power on the robot.</li> <li>c. If under Manual Mode, it requires the trigger of Enabling Switch function to release the brake of the robot.</li> </ol> </li> <li>2. If a external ESTOP button has been pressed: <ol style="list-style-type: none"> <li>a. Release the external ESTOP button.</li> <li>b. Trigger Robot Stick Reset button or user connected Reset input to power on the robot.</li> <li>c. If under Manual Mode, it requires the trigger of Enabling Switch function to release the brake of the robot.</li> </ol> </li> <li>3. If discrepancy happens in external safety device input: <ol style="list-style-type: none"> <li>a. Check and fix the wire connection on control box.</li> <li>b. Trigger the corresponded safety IO port for more than one seconds and than untrigger.</li> <li>c. Trigger Robot Stick Reset button or user connected Reset input to power on the robot.</li> <li>d. If under Manual Mode, it requires the trigger of Enabling Switch function to release the brake of the robot.</li> </ol> </li> </ol>
ErrorSuggestion00000053	<p>[Cause] The robot detected that voltage is over the specified range.</p> <p>[Caution] Ensure that the input power is within the working range.</p>

[Additional Explanation] Error can be caused when the payload is large, and the ABS speed is very fast.  
[Additional Explanation] a power eater board malfunction, power supply abnormality or a short circuited power cable can also be the cause of this error.

[Solution(End User)] To restore the robot from error status:

1. Avoid setting the ABS speed to fast in point nodes. This is especially important when the robot is moving with large payloads.
2. Ensure the power cables are securely connected.
3. Perform the robot restart procedure.
4. If there are any problems on the hardware after the restart procedure, please contact a qualified service engineer for additional support

[Solution(Robot Maintenance Staff)]

Check following status:

1. Remove the Robot Cable and turn on control box, and check if voltage shown on LCM is between 46~48.
2. Follow Troubleshooting Guide "Robot voltage error" for troubleshooting.

ErrorSuggestion00000054

[Cause] Power supply is abnormal

[Additional Explanation]

48V Power Supply over current may possibly caused by the following reasons:

1. There may have short circuit within the system (power supply, power board, joint)
2. The current project is with payload and speed over specification
3. The Joint is abnormal

[Additional Explanation]

1. Avoid and make sure the robot would not collided with the surroundings during running project or carrying
2. Prevent to use the robot with high speed and heavy payload that are out of specification

[Solution]

1. Restart the robot.
2. Remove the payload or slow down the project speed
3. If the problem still occur, contact a qualified service engineer for further analysis

ErrorSuggestion00000055

[Cause] The robot detect the current is over the range from 24V Power Supply.

[Additional Explanation]

24V Power Supply over current may possibly caused by the following reasons:

1. Power board is abnormal
2. IO is accidentally shorten
3. IO is connected with a over spec. load (1.5 a)
4. etc.

[Additional Explanation]

1. Beware and prevent short circuit on IO connection
2. Not to have over loading on IO power supply

[Solution]

1. Remove all IO connection and restart the robot
2. If the problem still occur, contact a qualified service engineer for further analysis

ErrorSuggestion00000056

[Cause] Robot detects a connection error on I/O Board

[Additional Explanation] If the control box is placed on a unstable platform, it may cause the cables loosen. Make sure the robot would not be collided and be placed on a unstable platform.

[Precaution] Power off and unplug the power cable before opening the control box for items checking

[Solution]

After restart the robot, the problem still occur, contact a qualified service engineer for further analysis

ErrorSuggestion00000057	<p>[Cause] Motor driver connection is abnormal</p> <p>[Precaution] Shutdown the robot before checking the inside of the joint. Make sure the robot is working on a stable platform</p> <p>[Solution]</p> <p>After restart the robot, the problem still occurs, contact a qualified service engineer for further analysis with log files.</p>
ErrorSuggestion00000058	<p>Please reboot the robot. If the error still occurs, please contact the original purchase of the manufacturer or a third party designated maintenance unit.</p>
ErrorSuggestion00000059	<p>Please reboot the robot. If the error still occurs, please contact the original purchase of the manufacturer or a third party designated maintenance unit.</p>
ErrorSuggestion0000005A	<p>Please reboot the robot. If the error still occurs, please contact the original purchase of the manufacturer or a third party designated maintenance unit.</p>
ErrorSuggestion0000005B	<p>Press the Play button on Robot Stick to resume.</p>
ErrorSuggestion0000005C	<p>[Cause]</p> <ol style="list-style-type: none"> <li>1. Robot Stick buzzer is abnormal</li> <li>2. Power Board is abnormal</li> </ol> <p>[Additional Explanation] When system get abnormal return data of stick buzzer, it will report this error</p> <p>[Solution]</p> <p>After restart the robot, the problem still occurs, contact a qualified service engineer for further analysis</p>
ErrorSuggestion0000005D	<p>[Cause] EtherCAT BUS is lost.</p> <p>[Additional Explanations] Usually, it requires 1ms to complete a communication cycle, but the last signal delayed for more than 5 ms.</p> <p>[Solution]</p> <p>After restart the robot, the problem still occurs, contact a qualified service engineer for further analysis with log files</p>
ErrorSuggestion0000005E	<p>[Cause] Safety Monitor Board detects some hardware or component are abnormal.</p> <p>[Caution]</p> <p>[Additional Explanations] Safety Monitor Board is responsible for monitoring whether each component has normal communication.</p> <p>[Solution] After restart the robot, the problem still occurs, contact a qualified service engineer for further analysis.</p>
ErrorSuggestion0000005F	<p>It is a test input pin triggered.</p>
ErrorSuggestion00000060	<p>[Cause] When user press FREE Button and using Controller with Robot Stick at same time, it would cause this issue.</p> <p>[Caution] Check the FREE Button or Controller are both pressed by something or someone at the same time</p> <p>[Additional Explanations] When user press FREE Button and using Controller at the same time, it means user send the motion command to robot, it would cause the conflict.</p> <p>[Solution]</p> <p>Stop pressing one of the FREE Button or Controller with Robot Stick. Check and avoid the FREE Button and the Controller with Robot Stick are triggered at same time.</p>
ErrorSuggestion00000061	<p>Motion command is not allowed with compliance mode at the same time</p>
ErrorSuggestion00000062	<p>[Cause] Robot reaches singularity during hand-guiding</p> <p>[Caution] Check the FreeBot settings on Controller, see if there are any axes is disabled</p> <p>[Additional Explanation] In ControllerFreeBot\Custom Setting, if some of the axe or joints are disabled, hand-guiding may trigger this error</p> <p>[Solution]</p> <ol style="list-style-type: none"> <li>1. Go to ControllerFreeBot and change the setting to "Free all Joints"</li> <li>2. Press the FREE button to drag the robot back from singularity position</li> <li>3. Make sure the motion of the robot will not trigger singularity before disabled the axes or joints for hand-guiding</li> </ol>
ErrorSuggestion00000063	<p>please set to "free all joints" in the teach mode and move the pose of the robot away from singularity.</p>

ErrorSuggestion00000066	<p>[Cause] Power Eater's temperature is too high because the environment is too hot or Power Eater is abnormal.</p> <p>[Additional Explanation] The servo would trigger this error if the Power Eater's temperature is higher than 80 °C.</p> <p>[Solution]</p> <ol style="list-style-type: none"> <li>1. Power off the robot and let it cool down for a while (suggest at least half a hour)</li> <li>2. Restart the robot, if the problem still occurs, contact a qualified service engineer for further analysis.</li> <li>3. Make sure the environment temperature is within the specification (0~50 °C) when robot is running.</li> </ol>
ErrorSuggestion0000006A	It is a test command
ErrorSuggestion0000006E	<p>[Cause] An unintended motion is detected while the robot is still in Cat. 2 Stop status.</p> <p>[Caution]</p> <ol style="list-style-type: none"> <li>1. Check the log for any Cat. 2 Stop codes prior to the current error code.</li> <li>2. Check if a collision occurred or if a joint is jammed</li> </ol> <p>[Additional Explanation] This safety function is automatically activated after every Cat.2 Stop. Encoders of each joint are monitored continuously to check if there is any unintended motion, until the user acknowledges and manually recovers the robot from Cat.2 Stop status. If there is any unintended motion, this safety function will trigger a Cat.0 Stop, cutting the power supply directly to the robot.</p> <p>[Precaution] When a unintended motion is detected while the robot is still in Cat. 2 Stop status, a Cat.0 Stop will issue, which means the power is cut off immediately; If there is any payload on the TCP, without drive power, the TCP will drop a little before coming to a complete stop. Please be aware that the tool (payload) does not collide with nearby objects.</p> <p>[Solution]</p> <ol style="list-style-type: none"> <li>1. Restart the robot.</li> <li>2. If the problem still occur, contact a qualified service engineer for further analysis.</li> </ol>
ErrorSuggestion0000006F	Please reboot the robot. If the error still occurs, please contact the original purchase of the manufacturer or a third party designated maintenance unit.
ErrorSuggestion00000070	<p>[Cause] Robot detects an unexpected error of vision servoing.</p> <p>[Caution] Robot detects an unexpected error of vision servoing.</p> <p>[Additional Explanation] This error should not likely happen.</p> <p>[Solution]</p> <p>If this error happens, contact to your agent or Techman Robot Inc. with the issued Project file.</p>
ErrorSuggestion00000071	Please make sure the Image is recognized and the vision servoing is keep working
ErrorSuggestion00000072	<p>[Cause] Robot is too close or at singularity during servoing process.</p> <p>[Caution] Check if the pose of the robot is too close or at singularity during vision serving process.</p> <p>[Additional Explanation]</p> <p>The possibility of robot moves into singularity depends of the initial (view) point chosen or the Moving Range settings of Visual Servoing</p> <ol style="list-style-type: none"> <li>1. Set up the initial (view) point of the vision job properly to make sure the robot would not enter Singularity</li> <li>2. Set up the Moving Range of Servoing properly to make sure the robot would not enter Singularity or hit anything of the layout</li> <li>3. It is suggested to use Fixed Point for object localization instead of Visual Servoing for non-open workspace (too narrow for servoing movement)</li> </ol> <p>[Precaution] Please assess the risk of collision during servoing during project editing</p> <p>[Solution]</p> <p>To restore the robot from error status:</p> <ol style="list-style-type: none"> <li>1. Press the STOP button on the Robot Stick to stop the project.</li> <li>2. Trigger Robot Stick Reset button or user connected Reset input to back to normal operation.</li> <li>3. Press FREE button to remove the robot from singularity.</li> </ol>
ErrorSuggestion00000073	Please calibrated the vision again.

ErrorSuggestion00000074	Please reboot the robot. If the error still occurs, please contact the original purchase of the manufacturer or a third party designated maintenance unit.
ErrorSuggestion00000075	Please make sure the Image is recognized stably.
ErrorSuggestion00000076	Please reboot the robot. If the error still occurs, please contact the original purchase of the manufacturer or a third party designated maintenance unit.
ErrorSuggestion00000080	Please contact the original purchase of the manufacturer or a third party designated maintenance unit.
ErrorSuggestion00000081	Please contact the original purchase of the manufacturer or a third party designated maintenance unit.
ErrorSuggestion00000082	Please contact the original purchase of the manufacturer or a third party designated maintenance unit.
ErrorSuggestion00000083	Please contact the original purchase of the manufacturer or a third party designated maintenance unit.
ErrorSuggestion00000084	Please contact the original purchase of the manufacturer or a third party designated maintenance unit.
ErrorSuggestion00000085	Please contact the original purchase of the manufacturer or a third party designated maintenance unit.
ErrorSuggestion00000086	Please contact the original purchase of the manufacturer or a third party designated maintenance unit.
ErrorSuggestion00000090	[Cause] Path execution error on PATH node [Caution] Check if the path would approaches any singularity [Additional Explanations] If the continuous point planned by user then execute occur error, it would cause this error. Make sure the path used would not approaches any singularity [Solution] 1. Press STOP button on the Robot Stick to stop the project 2. Adjust the path before usage
ErrorSuggestion000000A0	[Cause] Violate Encoder Standstill when no motion is allowed. [Caution] Check whether there are others error log along with this error. [Solution] 1. Restart the robot. 2. If the problem still occur, contact a qualified service engineer for further analysis.
ErrorSuggestion000000A1	[Cause] Violate Encoder Standstill when error occurred. [Caution] Check whether there are others error log along with this error. [Solution] 1. Restart the robot. 2. If the problem still occur, contact a qualified service engineer for further analysis.
ErrorSuggestion000000A2	[Cause] Violate Encoder Standstill when safeguard triggered [Caution] Check whether there are others error log along with this error. [Solution] 1. Restart the robot. 2. If the problem still occur, contact a qualified service engineer for further analysis.
ErrorSuggestion000000A3	[Cause] Violate Encoder Standstill when no motion is allowed. [Caution] Check whether there are others error log along with this error. [Solution] 1. Restart the robot. 2. If the problem still occur, contact a qualified service engineer for further analysis.
ErrorSuggestion000000A4	[Cause] Violate Encoder Standstill in stop area. [Caution] Check whether there are others error log along with this error. [Solution] 1. Restart the robot. 2. If the problem still occur, contact a qualified service engineer for further analysis.
ErrorSuggestion000000A6	[Cause] Dual channel Internal Protective Output do not trigger at the same time. [Caution] Fault(s) occurs in the internal system. [Solution]

ErrorSuggestion000000A7	<p>1. Restart the robot.</p> <p>2. If the problem still occur, contact a qualified service engineer for further analysis.</p> <p>[Cause] Dual channel Encoder Standstill Output do not trigger at the same time.</p> <p>[Caution] Fault(s) occurs in the internal system.</p> <p>[Solution]</p> <p>1. Restart the robot.</p> <p>2. If the problem still occur, contact a qualified service engineer for further analysis.</p>
ErrorSuggestion000000A8	<p>[Cause] Dual channel emergency stop ports do not trigger at the same time.</p> <p>[Caution] Check if the wire on the extension port(s) for emergency stop is securely fastened.</p> <p>[Additional Explanations] In order to comply with safety regulations, the emergency button external ports were designed to be simultaneously triggered.</p> <p>[Solution]</p> <p>1. Check and fix the wire connection on control box.</p> <p>2. Trigger the corresponded safety IO port for more than one seconds and than untrigger.</p> <p>3. Trigger Robot Stick Reset button or user connected Reset input to power on the robot.</p> <p>4. If under Manual Mode, it requires the trigger of Enabling Switch function to release the brake of the robot.</p>
ErrorSuggestion000000A9	<p>[Cause] Dual channel safeguard port A do not trigger at the same time.</p> <p>[Caution] Check if the wire on the external port(s) is securely fastened.</p> <p>[Solution]</p> <p>1. Check and fix the wire connection on control box.</p> <p>2. Trigger the corresponded safety IO port for more than one seconds and than untrigger.</p> <p>3. Trigger Robot Stick Reset button or user connected Reset input to power on the robot.</p> <p>4. If under Manual Mode, it requires the trigger of Enabling Switch function to release the brake of the robot.</p>
ErrorSuggestion000000AA	<p>[Cause] Dual channel safeguard port B do not trigger at the same time.</p> <p>[Caution] Check if the wire on the external port(s) is securely fastened.</p> <p>[Solution]</p> <p>1. Check and fix the wire connection on control box.</p> <p>2. Trigger the corresponded safety IO port for more than one seconds and than untrigger.</p> <p>3. Trigger Robot Stick Reset button or user connected Reset input to power on the robot.</p> <p>4. If under Manual Mode, it requires the trigger of Enabling Switch function to release the brake of the robot.</p>
ErrorSuggestion000000AB	<p>[Cause] Dual channel Enabling Switch Ports do not trigger at the same time.</p> <p>[Caution] Check if the wire on the external port(s) is securely fastened.</p> <p>[Solution]</p> <p>1. Check and fix the wire connection on control box.</p> <p>2. Trigger the corresponded safety IO port for more than one seconds and than untrigger.</p> <p>3. Trigger Robot Stick Reset button or user connected Reset input to power on the robot.</p> <p>4. If under Manual Mode, it requires the trigger of Enabling Switch function to release the brake of the robot.</p>
ErrorSuggestion000000AD	<p>[Cause] Dual channel Emergency Stop Output do not trigger at the same time.</p> <p>[Caution] Fault(s) occurs in the internal system.</p> <p>[Solution]</p> <p>1. Restart the robot.</p> <p>2. If the problem still occur, contact a qualified service engineer for further analysis</p>
ErrorSuggestion000000AE	<p>[Cause] Dual channel Safeguard Port a Output do not trigger at the same time.</p> <p>[Caution] Fault(s) occurs in the internal system.</p> <p>[Solution]</p> <p>1. Restart the robot.</p> <p>2. If the problem still occur, contact a qualified service engineer for further analysis</p>



ErrorSuggestion000000AF	<p>[Cause] Dual channel Safeguard Port B Output do not trigger at the same time.</p> <p>[Caution] Fault(s) occurs in the internal system.</p> <p>[Solution]</p> <ol style="list-style-type: none"> <li>1. Restart the robot.</li> <li>2. If the problem still occur, contact a qualified service engineer for further analysis</li> </ol>
ErrorSuggestion000000B0	<ol style="list-style-type: none"> <li>1. Please backup the HMI Log.</li> <li>2. Please contact the original purchase of the manufacturer or a third party designated maintenance unit.</li> </ol>
ErrorSuggestion000000C0	<p>[Cause]</p> <ol style="list-style-type: none"> <li>1. Violation of standstill monitoring function.</li> <li>2. Encoder related fault occurred.</li> </ol> <p>[Solution]</p> <ol style="list-style-type: none"> <li>1. Restart the robot.</li> <li>2. If the problem still occur, contact a qualified service engineer for further analysis.</li> </ol>
ErrorSuggestion000000C1	<p>[Cause]</p> <ol style="list-style-type: none"> <li>1. Safety IO port discrepancy occurred.</li> <li>2. Emergency Stop function triggered.</li> <li>3. Faults other than encoder related fault occurred.</li> <li>4. Safety Module Communication fault occurred.</li> </ol> <p>[Solution]</p> <ol style="list-style-type: none"> <li>1. If Safety IO port discrepancy occurred: <ol style="list-style-type: none"> <li>a. Check and fix the wire connection on control box.</li> <li>b. Trigger the corresponded safety IO port for more than one seconds and than untrigger.</li> <li>c. Trigger Robot Stick Reset button or user connected Reset input to power on the robot.</li> <li>d.If under Manual Mode, it requires the trigger of Enabling Switch function to release the brake of the robot.</li> </ol> </li> <li>2. If Emergency Stop function triggered: <ol style="list-style-type: none"> <li>a. Restore the Emergency Stop button.</li> <li>b. Trigger Robot Stick Reset button or user connected Reset input to power on the robot.</li> <li>c.If under Manual Mode, it requires the trigger of Enabling Switch function to release the brake of the robot.</li> </ol> </li> <li>3. If Faults other than encoder related fault or Safety Module Communication fault occurred: <ol style="list-style-type: none"> <li>a. Restart the robot.</li> <li>b. If the problem still occur, contact a qualified service engineer for further analysis.</li> </ol> </li> </ol>
ErrorSuggestion000000C2	<p>[Cause]</p> <ol style="list-style-type: none"> <li>1. Cat.2 Stop safety functions triggered.</li> <li>2. Robot Stick status changing.</li> <li>3. Operation Mode changing.</li> <li>4. Configuration Tool logging in.</li> </ol> <p>[Solution]</p> <ol style="list-style-type: none"> <li>1. If Cat.2 Stop safety functions triggered: <ol style="list-style-type: none"> <li>a. Solve the triggered situation.</li> <li>b. Trigger Robot Stick Reset button or user connected Reset input to back to normal operation.</li> </ol> </li> <li>2. If Robot Stick status or Operation Mode changing: <ol style="list-style-type: none"> <li>a. Finish or leave the Robot Stick status changing procedure or Operation Mode changing procedure.</li> </ol> </li> <li>3. If Configuration Tool logging in: <ol style="list-style-type: none"> <li>a. Finish safety parameters configuration and log out the Configuration Tool.</li> </ol> </li> </ol>
ErrorSuggestion000000C3	N/a
ErrorSuggestion000000C4	N/a
ErrorSuggestion000000C5	N/a



ErrorSuggestion000000CB	[Cause] Safety Module Settings Error [Solution] 1. Re-apply the safety settings again. 2. If the problem still occur, contact a qualified service engineer for further analysis.
ErrorSuggestion000000CC	[Cause] Safety Module Communication Fault [Solution] 1. Restart the robot. 2. If the problem still occur, contact a qualified service engineer for further analysis.
ErrorSuggestion000000CD	[Cause] Safety IO port discrepancy occurred. [Caution] Check the wire between the Robot Stick/External devices and the control box is securely connected and is not triggered. [Solution] 1. Check and fix the wire connection on control box. 2. Trigger the corresponded safety IO port for more than one seconds and than untrigger. 3. Trigger Robot Stick Reset button or user connected Reset input to power on the robot. 4. If under Manual Mode, it requires the trigger of Enabling Switch function to release the brake of the robot. 5. If the problem still occur, contact a qualified service engineer for further analysis.
ErrorSuggestion000000CE	[Cause] Safety Module Systematic Fault [Solution] 1. Restart the robot. 2. If the problem still occur, contact a qualified service engineer for further analysis.
ErrorSuggestion000000CF	[Cause] Safety Module Communication Fault [Solution] 1. Restart the robot. 2. If the problem still occur, contact a qualified service engineer for further analysis.
ErrorSuggestion000000F0	N/a
ErrorSuggestion00004500	Please reboot the robot. If the error still occurs, please contact the original purchase of the manufacturer or a third party designated maintenance unit.
ErrorSuggestion00004501	Please reboot the robot. If the error still occurs, please contact the original purchase of the manufacturer or a third party designated maintenance unit.
ErrorSuggestion00004502	Please reboot the robot. If the error still occurs, please contact the original purchase of the manufacturer or a third party designated maintenance unit.
ErrorSuggestion00004503	Please reboot the robot. If the error still occurs, please contact the original purchase of the manufacturer or a third party designated maintenance unit.
ErrorSuggestion00004504	Please reboot the robot. If the error still occurs, please contact the original purchase of the manufacturer or a third party designated maintenance unit.
ErrorSuggestion00004505	Please reboot the robot. If the error still occurs, please contact the original purchase of the manufacturer or a third party designated maintenance unit.
ErrorSuggestion00004506	Please reboot the robot. If the error still occurs, please contact the original purchase of the manufacturer or a third party designated maintenance unit.
ErrorSuggestion00004507	Please reboot the robot. If the error still occurs, please contact the original purchase of the manufacturer or a third party designated maintenance unit.
ErrorSuggestion00004508	Please reboot the robot. If the error still occurs, please contact the original purchase of the manufacturer or a third party designated maintenance unit.
ErrorSuggestion0000C211	[Cause] Robot joint position exceeds limit. [Caution] The robot will enter Recovery mode. Soft Axis safety limit and the trigger of Human-Machine Safety Settings will be disabled.

ErrorSuggestion0000C212	<p>[Additional Explanation] While the robot under Recovery mode, the safety parameters will follow Human-Machine Safety Settings and the end point reduce speed limit will always functioning.</p> <p>[Solution]</p> <ol style="list-style-type: none"> <li>1. Check the safety tool point position set.</li> <li>2. Check the payloads, speed setting and limit.</li> <li>3. Jog or hand guide the robot back the limited space manually.</li> <li>4. Trigger Robot Stick Reset button or user connected Reset input to leave Recovery mode and back to normal operation.</li> </ol>
ErrorSuggestion0000C213	<p>[Cause] Robot joint position exceeds limit.</p> <p>[Caution] The robot will enter Recovery mode. Soft Axis safety limit and the trigger of Human-Machine Safety Settings will be disabled.</p> <p>[Additional Explanation] While the robot under Recovery mode, the safety parameters will follow Human-Machine Safety Settings and the end point reduce speed limit will always functioning.</p> <p>[Solution]</p> <ol style="list-style-type: none"> <li>1. Check the safety tool point position set.</li> <li>2. Check the payloads, speed setting and limit.</li> <li>3. Jog or hand guide the robot back the limited space manually.</li> <li>4. Trigger Robot Stick Reset button or user connected Reset input to leave Recovery mode and back to normal operation.</li> </ol>
ErrorSuggestion0000C214	<p>[Cause] Robot joint position exceeds limit.</p> <p>[Caution] The robot will enter Recovery mode. Soft Axis safety limit and the trigger of Human-Machine Safety Settings will be disabled.</p> <p>[Additional Explanation] While the robot under Recovery mode, the safety parameters will follow Human-Machine Safety Settings and the end point reduce speed limit will always functioning.</p> <p>[Solution]</p> <ol style="list-style-type: none"> <li>1. Check the safety tool point position set.</li> <li>2. Check the payloads, speed setting and limit.</li> <li>3. Jog or hand guide the robot back the limited space manually.</li> <li>4. Trigger Robot Stick Reset button or user connected Reset input to leave Recovery mode and back to normal operation.</li> </ol>
ErrorSuggestion0000C215	<p>[Cause] Robot joint position exceeds limit.</p> <p>[Caution] The robot will enter Recovery mode. Soft Axis safety limit and the trigger of Human-Machine Safety Settings will be disabled.</p> <p>[Additional Explanation] While the robot under Recovery mode, the safety parameters will follow Human-Machine Safety Settings and the end point reduce speed limit will always functioning.</p> <p>[Solution]</p> <ol style="list-style-type: none"> <li>1. Check the safety tool point position set.</li> <li>2. Check the payloads, speed setting and limit.</li> <li>3. Jog or hand guide the robot back the limited space manually.</li> <li>4. Trigger Robot Stick Reset button or user connected Reset input to leave Recovery mode and back to normal operation.</li> </ol>

ErrorSuggestion0000C216

1. Check the safety tool point position set.
2. Check the payloads, speed setting and limit.
3. Jog or hand guide the robot back the limited space manually.
4. Trigger Robot Stick Reset button or user connected Reset input to leave Recovery mode and back to normal operation.

[Cause] Robot joint position exceeds limit.

[Caution] The robot will enter Recovery mode. Soft Axis safety limit and the trigger of Human-Machine Safety Settings will be disabled.

[Additional Explanation] While the robot under Recovery mode, the safety parameters will follow Human-Machine Safety Settings and the end point reduce speed limit will always functioning.

[Solution]

1. Check the safety tool point position set.
2. Check the payloads, speed setting and limit.
3. Jog or hand guide the robot back the limited space manually.
4. Trigger Robot Stick Reset button or user connected Reset input to leave Recovery mode and back to normal operation.

ErrorSuggestion0000C221

[Cause] Robot joint speed exceeds limit.

[Caution] The robot will enter Recovery mode. Soft Axis safety limit and the trigger of Human-Machine Safety Settings will be disabled.

[Additional Explanation] While the robot under Recovery mode, the safety parameters will follow Human-Machine Safety Settings and the end point reduce speed limit will always functioning.

[Solution]

1. Check the safety tool point position set.
2. Check the payloads, speed setting and limit.
3. Jog or hand guide the robot back the limited space manually.
4. Trigger Robot Stick Reset button or user connected Reset input to leave Recovery mode and back to normal operation.

ErrorSuggestion0000C222

[Cause] Robot joint speed exceeds limit.

[Caution] The robot will enter Recovery mode. Soft Axis safety limit and the trigger of Human-Machine Safety Settings will be disabled.

[Additional Explanation] While the robot under Recovery mode, the safety parameters will follow Human-Machine Safety Settings and the end point reduce speed limit will always functioning.

[Solution]

1. Check the safety tool point position set.
2. Check the payloads, speed setting and limit.
3. Jog or hand guide the robot back the limited space manually.
4. Trigger Robot Stick Reset button or user connected Reset input to leave Recovery mode and back to normal operation.

ErrorSuggestion0000C223

[Cause] Robot joint speed exceeds limit.

[Caution] The robot will enter Recovery mode. Soft Axis safety limit and the trigger of Human-Machine Safety Settings will be disabled.

[Additional Explanation] While the robot under Recovery mode, the safety parameters will follow Human-Machine Safety Settings and the end point reduce speed limit will always functioning.

[Solution]

1. Check the safety tool point position set.
2. Check the payloads, speed setting and limit.
3. Jog or hand guide the robot back the limited space manually.

ErrorSuggestion0000C224	<p>4. Trigger Robot Stick Reset button or user connected Reset input to leave Recovery mode and back to normal operation.</p> <p>[Cause] Robot joint speed exceeds limit.</p> <p>[Caution] The robot will enter Recovery mode. Soft Axis safety limit and the trigger of Human-Machine Safety Settings will be disabled.</p> <p>[Additional Explanation] While the robot under Recovery mode, the safety parameters will follow Human-Machine Safety Settings and the end point reduce speed limit will always functioning.</p> <p>[Solution]</p> <ol style="list-style-type: none"> <li>1. Check the safety tool point position set.</li> <li>2. Check the payloads, speed setting and limit.</li> <li>3. Jog or hand guide the robot back the limited space manually.</li> <li>4. Trigger Robot Stick Reset button or user connected Reset input to leave Recovery mode and back to normal operation.</li> </ol>
ErrorSuggestion0000C225	<p>[Cause] Robot joint speed exceeds limit.</p> <p>[Caution] The robot will enter Recovery mode. Soft Axis safety limit and the trigger of Human-Machine Safety Settings will be disabled.</p> <p>[Additional Explanation] While the robot under Recovery mode, the safety parameters will follow Human-Machine Safety Settings and the end point reduce speed limit will always functioning.</p> <p>[Solution]</p> <ol style="list-style-type: none"> <li>1. Check the safety tool point position set.</li> <li>2. Check the payloads, speed setting and limit.</li> <li>3. Jog or hand guide the robot back the limited space manually.</li> <li>4. Trigger Robot Stick Reset button or user connected Reset input to leave Recovery mode and back to normal operation.</li> </ol>
ErrorSuggestion0000C226	<p>[Cause] Robot joint speed exceeds limit.</p> <p>[Caution] The robot will enter Recovery mode. Soft Axis safety limit and the trigger of Human-Machine Safety Settings will be disabled.</p> <p>[Additional Explanation] While the robot under Recovery mode, the safety parameters will follow Human-Machine Safety Settings and the end point reduce speed limit will always functioning.</p> <p>[Solution]</p> <ol style="list-style-type: none"> <li>1. Check the safety tool point position set.</li> <li>2. Check the payloads, speed setting and limit.</li> <li>3. Jog or hand guide the robot back the limited space manually.</li> <li>4. Trigger Robot Stick Reset button or user connected Reset input to leave Recovery mode and back to normal operation.</li> </ol>
ErrorSuggestion0000C231	<p>[Cause] Robot safety tool point/elbow position exceeds Cartesian limit</p> <p>[Caution] The robot will enter Recovery mode. Soft Axis safety limit and the trigger of Human-Machine Safety Settings will be disabled.</p> <p>[Additional Explanation] While the robot under Recovery mode, the safety parameters will follow Human-Machine Safety Settings and the end point reduce speed limit will always functioning.</p> <p>[Solution]</p> <ol style="list-style-type: none"> <li>1. Check the safety tool point position set.</li> <li>2. Check the payloads, speed setting and limit.</li> <li>3. Jog or hand guide the robot back the limited space manually.</li> <li>4. Trigger Robot Stick Reset button or user connected Reset input to leave Recovery mode and back to normal operation.</li> </ol>

ErrorSuggestion0000C232	<p>[Cause] Robot safety tool point/elbow position exceeds Cartesian limit</p> <p>[Caution] The robot will enter Recovery mode. Soft Axis safety limit and the trigger of Human-Machine Safety Settings will be disabled.</p> <p>[Additional Explanation] While the robot under Recovery mode, the safety parameters will follow Human-Machine Safety Settings and the end point reduce speed limit will always functioning.</p> <p>[Solution]</p> <ol style="list-style-type: none"> <li>1. Check the safety tool point position set.</li> <li>2. Check the payloads, speed setting and limit.</li> <li>3. Jog or hand guide the robot back the limited space manually.</li> <li>4. Trigger Robot Stick Reset button or user connected Reset input to leave Recovery mode and back to normal operation.</li> </ol>
ErrorSuggestion0000C233	<p>[Cause] Robot safety tool point/elbow position exceeds Cartesian limit</p> <p>[Caution] The robot will enter Recovery mode. Soft Axis safety limit and the trigger of Human-Machine Safety Settings will be disabled.</p> <p>[Additional Explanation] While the robot under Recovery mode, the safety parameters will follow Human-Machine Safety Settings and the end point reduce speed limit will always functioning.</p> <p>[Solution]</p> <ol style="list-style-type: none"> <li>1. Check the safety tool point position set.</li> <li>2. Check the payloads, speed setting and limit.</li> <li>3. Jog or hand guide the robot back the limited space manually.</li> <li>4. Trigger Robot Stick Reset button or user connected Reset input to leave Recovery mode and back to normal operation.</li> </ol>
ErrorSuggestion0000C234	<p>[Cause] Robot safety tool point/elbow position exceeds Cartesian limit</p> <p>[Caution] The robot will enter Recovery mode. Soft Axis safety limit and the trigger of Human-Machine Safety Settings will be disabled.</p> <p>[Additional Explanation] While the robot under Recovery mode, the safety parameters will follow Human-Machine Safety Settings and the end point reduce speed limit will always functioning.</p> <p>[Solution]</p> <ol style="list-style-type: none"> <li>1. Check the safety tool point position set.</li> <li>2. Check the payloads, speed setting and limit.</li> <li>3. Jog or hand guide the robot back the limited space manually.</li> <li>4. Trigger Robot Stick Reset button or user connected Reset input to leave Recovery mode and back to normal operation.</li> </ol>
ErrorSuggestion0000C235	<p>[Cause] Robot safety tool point/elbow position exceeds Cartesian limit</p> <p>[Caution] The robot will enter Recovery mode. Soft Axis safety limit and the trigger of Human-Machine Safety Settings will be disabled.</p> <p>[Additional Explanation] While the robot under Recovery mode, the safety parameters will follow Human-Machine Safety Settings and the end point reduce speed limit will always functioning.</p> <p>[Solution]</p> <ol style="list-style-type: none"> <li>1. Check the safety tool point position set.</li> <li>2. Check the payloads, speed setting and limit.</li> <li>3. Jog or hand guide the robot back the limited space manually.</li> <li>4. Trigger Robot Stick Reset button or user connected Reset input to leave Recovery mode and back to normal operation.</li> </ol>
ErrorSuggestion0000C236	<p>[Cause] Robot safety tool point/elbow position exceeds Cartesian limit</p> <p>[Caution] The robot will enter Recovery mode. Soft Axis safety limit and the trigger of Human-Machine Safety Settings will be disabled.</p>

ErrorSuggestion0000C237	<p>[Additional Explanation] While the robot under Recovery mode, the safety parameters will follow Human-Machine Safety Settings and the end point reduce speed limit will always functioning.</p> <p>[Solution]</p> <ol style="list-style-type: none"> <li>1. Check the safety tool point position set.</li> <li>2. Check the payloads, speed setting and limit.</li> <li>3. Jog or hand guide the robot back the limited space manually.</li> <li>4. Trigger Robot Stick Reset button or user connected Reset input to leave Recovery mode and back to normal operation.</li> </ol>
ErrorSuggestion0000C238	<p>[Cause] Robot safety tool point/elbow position exceeds Cartesian limit</p> <p>[Caution] The robot will enter Recovery mode. Soft Axis safety limit and the trigger of Human-Machine Safety Settings will be disabled.</p> <p>[Additional Explanation] While the robot under Recovery mode, the safety parameters will follow Human-Machine Safety Settings and the end point reduce speed limit will always functioning.</p> <p>[Solution]</p> <ol style="list-style-type: none"> <li>1. Check the safety tool point position set.</li> <li>2. Check the payloads, speed setting and limit.</li> <li>3. Jog or hand guide the robot back the limited space manually.</li> <li>4. Trigger Robot Stick Reset button or user connected Reset input to leave Recovery mode and back to normal operation.</li> </ol>
ErrorSuggestion0000C239	<p>[Cause] Robot safety tool point/elbow position exceeds Cartesian limit</p> <p>[Caution] The robot will enter Recovery mode. Soft Axis safety limit and the trigger of Human-Machine Safety Settings will be disabled.</p> <p>[Additional Explanation] While the robot under Recovery mode, the safety parameters will follow Human-Machine Safety Settings and the end point reduce speed limit will always functioning.</p> <p>[Solution]</p> <ol style="list-style-type: none"> <li>1. Check the safety tool point position set.</li> <li>2. Check the payloads, speed setting and limit.</li> <li>3. Jog or hand guide the robot back the limited space manually.</li> <li>4. Trigger Robot Stick Reset button or user connected Reset input to leave Recovery mode and back to normal operation.</li> </ol>
ErrorSuggestion0000C23A	<p>[Cause] Robot safety tool point/elbow position exceeds Cartesian limit</p> <p>[Caution] The robot will enter Recovery mode. Soft Axis safety limit and the trigger of Human-Machine Safety Settings will be disabled.</p> <p>[Additional Explanation] While the robot under Recovery mode, the safety parameters will follow Human-Machine Safety Settings and the end point reduce speed limit will always functioning.</p> <p>[Solution]</p> <ol style="list-style-type: none"> <li>1. Check the safety tool point position set.</li> <li>2. Check the payloads, speed setting and limit.</li> <li>3. Jog or hand guide the robot back the limited space manually.</li> <li>4. Trigger Robot Stick Reset button or user connected Reset input to leave Recovery mode and back to normal operation.</li> </ol>

ErrorSuggestion0000C241	<ol style="list-style-type: none"> <li>1. Check the safety tool point position set.</li> <li>2. Check the payloads, speed setting and limit.</li> <li>3. Jog or hand guide the robot back the limited space manually.</li> <li>4. Trigger Robot Stick Reset button or user connected Reset input to leave Recovery mode and back to normal operation.</li> </ol> <p>[Cause] Robot safety tool point/elbow speed exceeds limit</p> <p>[Caution] The robot will enter Recovery mode. Soft Axis safety limit and the trigger of Human-Machine Safety Settings will be disabled.</p> <p>[Additional Explanation] While the robot under Recovery mode, the safety parameters will follow Human-Machine Safety Settings and the end point reduce speed limit will always functioning.</p> <p>[Solution]</p> <ol style="list-style-type: none"> <li>1. Check the safety tool point position set.</li> <li>2. Check the payloads, speed setting and limit.</li> <li>3. Jog or hand guide the robot back the limited space manually.</li> <li>4. Trigger Robot Stick Reset button or user connected Reset input to leave Recovery mode and back to normal operation.</li> </ol>
ErrorSuggestion0000C242	<p>[Cause] Robot safety tool point/elbow speed exceeds limit</p> <p>[Caution] The robot will enter Recovery mode. Soft Axis safety limit and the trigger of Human-Machine Safety Settings will be disabled.</p> <p>[Additional Explanation] While the robot under Recovery mode, the safety parameters will follow Human-Machine Safety Settings and the end point reduce speed limit will always functioning.</p> <p>[Solution]</p> <ol style="list-style-type: none"> <li>1. Check the safety tool point position set.</li> <li>2. Check the payloads, speed setting and limit.</li> <li>3. Jog or hand guide the robot back the limited space manually.</li> <li>4. Trigger Robot Stick Reset button or user connected Reset input to leave Recovery mode and back to normal operation.</li> </ol>
ErrorSuggestion0000C243	<p>[Cause] Robot safety tool point/elbow speed exceeds limit</p> <p>[Caution] The robot will enter Recovery mode. Soft Axis safety limit and the trigger of Human-Machine Safety Settings will be disabled.</p> <p>[Additional Explanation] While the robot under Recovery mode, the safety parameters will follow Human-Machine Safety Settings and the end point reduce speed limit will always functioning.</p> <p>[Solution]</p> <ol style="list-style-type: none"> <li>1. Check the safety tool point position set.</li> <li>2. Check the payloads, speed setting and limit.</li> <li>3. Jog or hand guide the robot back the limited space manually.</li> <li>4. Trigger Robot Stick Reset button or user connected Reset input to leave Recovery mode and back to normal operation.</li> </ol>
ErrorSuggestion0000C244	<p>[Cause] Robot safety tool point/elbow speed exceeds limit</p> <p>[Caution] The robot will enter Recovery mode. Soft Axis safety limit and the trigger of Human-Machine Safety Settings will be disabled.</p> <p>[Additional Explanation] While the robot under Recovery mode, the safety parameters will follow Human-Machine Safety Settings and the end point reduce speed limit will always functioning.</p> <p>[Solution]</p> <ol style="list-style-type: none"> <li>1. Check the safety tool point position set.</li> <li>2. Check the payloads, speed setting and limit.</li> <li>3. Jog or hand guide the robot back the limited space manually.</li> </ol>



ErrorSuggestion0000C245	<p>4. Trigger Robot Stick Reset button or user connected Reset input to leave Recovery mode and back to normal operation.</p> <p>[Cause] Robot safety tool point/elbow speed exceeds limit</p> <p>[Caution] The robot will enter Recovery mode. Soft Axis safety limit and the trigger of Human-Machine Safety Settings will be disabled.</p> <p>[Additional Explanation] While the robot under Recovery mode, the safety parameters will follow Human-Machine Safety Settings and the end point reduce speed limit will always functioning.</p> <p>[Solution]</p> <ol style="list-style-type: none"> <li>1. Check the safety tool point position set.</li> <li>2. Check the payloads, speed setting and limit.</li> <li>3. Jog or hand guide the robot back the limited space manually.</li> <li>4. Trigger Robot Stick Reset button or user connected Reset input to leave Recovery mode and back to normal operation.</li> </ol>
ErrorSuggestion0000C246	<p>[Cause] Robot safety tool point/elbow speed exceeds limit</p> <p>[Caution] The robot will enter Recovery mode. Soft Axis safety limit and the trigger of Human-Machine Safety Settings will be disabled.</p> <p>[Additional Explanation] While the robot under Recovery mode, the safety parameters will follow Human-Machine Safety Settings and the end point reduce speed limit will always functioning.</p> <p>[Solution]</p> <ol style="list-style-type: none"> <li>1. Check the safety tool point position set.</li> <li>2. Check the payloads, speed setting and limit.</li> <li>3. Jog or hand guide the robot back the limited space manually.</li> <li>4. Trigger Robot Stick Reset button or user connected Reset input to leave Recovery mode and back to normal operation.</li> </ol>
ErrorSuggestion0000C247	<p>[Cause] Robot safety tool point/elbow speed exceeds limit</p> <p>[Caution] The robot will enter Recovery mode. Soft Axis safety limit and the trigger of Human-Machine Safety Settings will be disabled.</p> <p>[Additional Explanation] While the robot under Recovery mode, the safety parameters will follow Human-Machine Safety Settings and the end point reduce speed limit will always functioning.</p> <p>[Solution]</p> <ol style="list-style-type: none"> <li>1. Check the safety tool point position set.</li> <li>2. Check the payloads, speed setting and limit.</li> <li>3. Jog or hand guide the robot back the limited space manually.</li> <li>4. Trigger Robot Stick Reset button or user connected Reset input to leave Recovery mode and back to normal operation.</li> </ol>
ErrorSuggestion0000C248	<p>[Cause] Robot safety tool point/elbow speed exceeds limit</p> <p>[Caution] The robot will enter Recovery mode. Soft Axis safety limit and the trigger of Human-Machine Safety Settings will be disabled.</p> <p>[Additional Explanation] While the robot under Recovery mode, the safety parameters will follow Human-Machine Safety Settings and the end point reduce speed limit will always functioning.</p> <p>[Solution]</p> <ol style="list-style-type: none"> <li>1. Check the safety tool point position set.</li> <li>2. Check the payloads, speed setting and limit.</li> <li>3. Jog or hand guide the robot back the limited space manually.</li> <li>4. Trigger Robot Stick Reset button or user connected Reset input to leave Recovery mode and back to normal operation.</li> </ol>



ErrorSuggestion0000C249	<p>[Cause] Robot safety tool point/elbow speed exceeds limit</p> <p>[Caution] The robot will enter Recovery mode. Soft Axis safety limit and the trigger of Human-Machine Safety Settings will be disabled.</p> <p>[Additional Explanation] While the robot under Recovery mode, the safety parameters will follow Human-Machine Safety Settings and the end point reduce speed limit will always functioning.</p> <p>[Solution]</p> <ol style="list-style-type: none"> <li>1. Check the safety tool point position set.</li> <li>2. Check the payloads, speed setting and limit.</li> <li>3. Jog or hand guide the robot back the limited space manually.</li> <li>4. Trigger Robot Stick Reset button or user connected Reset input to leave Recovery mode and back to normal operation.</li> </ol>
ErrorSuggestion0000C24A	<p>[Cause] Robot safety tool point/elbow speed exceeds limit</p> <p>[Caution] The robot will enter Recovery mode. Soft Axis safety limit and the trigger of Human-Machine Safety Settings will be disabled.</p> <p>[Additional Explanation] While the robot under Recovery mode, the safety parameters will follow Human-Machine Safety Settings and the end point reduce speed limit will always functioning.</p> <p>[Solution]</p> <ol style="list-style-type: none"> <li>1. Check the safety tool point position set.</li> <li>2. Check the payloads, speed setting and limit.</li> <li>3. Jog or hand guide the robot back the limited space manually.</li> <li>4. Trigger Robot Stick Reset button or user connected Reset input to leave Recovery mode and back to normal operation.</li> </ol>
ErrorSuggestion0000C251	<p>[Cause] Robot safety tool point/end-point speed exceeds reduced speed limit</p> <p>[Caution] The robot will enter Recovery mode. Soft Axis safety limit and the trigger of Human-Machine Safety Settings will be disabled.</p> <p>[Additional Explanation] While the robot under Recovery mode, the safety parameters will follow Human-Machine Safety Settings and the end point reduce speed limit will always functioning.</p> <p>[Solution]</p> <ol style="list-style-type: none"> <li>1. Check the safety tool point position set.</li> <li>2. Check the payloads, speed setting and limit.</li> <li>3. Jog or hand guide the robot back the limited space manually.</li> <li>4. Trigger Robot Stick Reset button or user connected Reset input to leave Recovery mode and back to normal operation.</li> </ol>
ErrorSuggestion0000C252	<p>[Cause] Robot safety tool point/end-point speed exceeds reduced speed limit</p> <p>[Caution] The robot will enter Recovery mode. Soft Axis safety limit and the trigger of Human-Machine Safety Settings will be disabled.</p> <p>[Additional Explanation] While the robot under Recovery mode, the safety parameters will follow Human-Machine Safety Settings and the end point reduce speed limit will always functioning.</p> <p>[Solution]</p> <ol style="list-style-type: none"> <li>1. Check the safety tool point position set.</li> <li>2. Check the payloads, speed setting and limit.</li> <li>3. Jog or hand guide the robot back the limited space manually.</li> <li>4. Trigger Robot Stick Reset button or user connected Reset input to leave Recovery mode and back to normal operation.</li> </ol>
ErrorSuggestion0000C253	<p>[Cause] Robot safety tool point/end-point speed exceeds reduced speed limit</p> <p>[Caution] The robot will enter Recovery mode. Soft Axis safety limit and the trigger of Human-Machine Safety Settings will be disabled.</p>

ErrorSuggestion0000C254	<p>[Additional Explanation] While the robot under Recovery mode, the safety parameters will follow Human-Machine Safety Settings and the end point reduce speed limit will always functioning.</p> <p>[Solution]</p> <ol style="list-style-type: none"> <li>1. Check the safety tool point position set.</li> <li>2. Check the payloads, speed setting and limit.</li> <li>3. Jog or hand guide the robot back the limited space manually.</li> <li>4. Trigger Robot Stick Reset button or user connected Reset input to leave Recovery mode and back to normal operation.</li> </ol>
ErrorSuggestion0000C255	<p>[Cause] Robot safety tool point/end-point speed exceeds reduced speed limit</p> <p>[Caution] The robot will enter Recovery mode. Soft Axis safety limit and the trigger of Human-Machine Safety Settings will be disabled.</p> <p>[Additional Explanation] While the robot under Recovery mode, the safety parameters will follow Human-Machine Safety Settings and the end point reduce speed limit will always functioning.</p> <p>[Solution]</p> <ol style="list-style-type: none"> <li>1. Check the safety tool point position set.</li> <li>2. Check the payloads, speed setting and limit.</li> <li>3. Jog or hand guide the robot back the limited space manually.</li> <li>4. Trigger Robot Stick Reset button or user connected Reset input to leave Recovery mode and back to normal operation.</li> </ol>
ErrorSuggestion0000C256	<p>[Cause] Robot safety tool point/end-point speed exceeds reduced speed limit</p> <p>[Caution] The robot will enter Recovery mode. Soft Axis safety limit and the trigger of Human-Machine Safety Settings will be disabled.</p> <p>[Additional Explanation] While the robot under Recovery mode, the safety parameters will follow Human-Machine Safety Settings and the end point reduce speed limit will always functioning.</p> <p>[Solution]</p> <ol style="list-style-type: none"> <li>1. Check the safety tool point position set.</li> <li>2. Check the payloads, speed setting and limit.</li> <li>3. Jog or hand guide the robot back the limited space manually.</li> <li>4. Trigger Robot Stick Reset button or user connected Reset input to leave Recovery mode and back to normal operation.</li> </ol>
ErrorSuggestion0000C257	<p>[Cause] Robot safety tool point/end-point speed exceeds reduced speed limit</p> <p>[Caution] The robot will enter Recovery mode. Soft Axis safety limit and the trigger of Human-Machine Safety Settings will be disabled.</p> <p>[Additional Explanation] While the robot under Recovery mode, the safety parameters will follow Human-Machine Safety Settings and the end point reduce speed limit will always functioning.</p> <p>[Solution]</p> <ol style="list-style-type: none"> <li>1. Check the safety tool point position set.</li> <li>2. Check the payloads, speed setting and limit.</li> <li>3. Jog or hand guide the robot back the limited space manually.</li> <li>4. Trigger Robot Stick Reset button or user connected Reset input to leave Recovery mode and back to normal operation.</li> </ol>

ErrorSuggestion0000C258	<ol style="list-style-type: none"> <li>1. Check the safety tool point position set.</li> <li>2. Check the payloads, speed setting and limit.</li> <li>3. Jog or hand guide the robot back the limited space manually.</li> <li>4. Trigger Robot Stick Reset button or user connected Reset input to leave Recovery mode and back to normal operation.</li> </ol> <p>[Cause] Robot safety tool point/end-point speed exceeds reduced speed limit</p> <p>[Caution] The robot will enter Recovery mode. Soft Axis safety limit and the trigger of Human-Machine Safety Settings will be disabled.</p> <p>[Additional Explanation] While the robot under Recovery mode, the safety parameters will follow Human-Machine Safety Settings and the end point reduce speed limit will always functioning.</p> <p>[Solution]</p> <ol style="list-style-type: none"> <li>1. Check the safety tool point position set.</li> <li>2. Check the payloads, speed setting and limit.</li> <li>3. Jog or hand guide the robot back the limited space manually.</li> <li>4. Trigger Robot Stick Reset button or user connected Reset input to leave Recovery mode and back to normal operation.</li> </ol>
ErrorSuggestion0000C259	<p>[Cause] Robot safety tool point/end-point speed exceeds reduced speed limit</p> <p>[Caution] The robot will enter Recovery mode. Soft Axis safety limit and the trigger of Human-Machine Safety Settings will be disabled.</p> <p>[Additional Explanation] While the robot under Recovery mode, the safety parameters will follow Human-Machine Safety Settings and the end point reduce speed limit will always functioning.</p> <p>[Solution]</p> <ol style="list-style-type: none"> <li>1. Check the safety tool point position set.</li> <li>2. Check the payloads, speed setting and limit.</li> <li>3. Jog or hand guide the robot back the limited space manually.</li> <li>4. Trigger Robot Stick Reset button or user connected Reset input to leave Recovery mode and back to normal operation.</li> </ol>
ErrorSuggestion0000C25A	<p>[Cause] Robot safety tool point/end-point speed exceeds reduced speed limit</p> <p>[Caution] The robot will enter Recovery mode. Soft Axis safety limit and the trigger of Human-Machine Safety Settings will be disabled.</p> <p>[Additional Explanation] While the robot under Recovery mode, the safety parameters will follow Human-Machine Safety Settings and the end point reduce speed limit will always functioning.</p> <p>[Solution]</p> <ol style="list-style-type: none"> <li>1. Check the safety tool point position set.</li> <li>2. Check the payloads, speed setting and limit.</li> <li>3. Jog or hand guide the robot back the limited space manually.</li> <li>4. Trigger Robot Stick Reset button or user connected Reset input to leave Recovery mode and back to normal operation.</li> </ol>
ErrorSuggestion0000C25B	<p>[Cause] Robot safety tool point/end-point speed exceeds reduced speed limit</p> <p>[Caution] The robot will enter Recovery mode. Soft Axis safety limit and the trigger of Human-Machine Safety Settings will be disabled.</p> <p>[Additional Explanation] While the robot under Recovery mode, the safety parameters will follow Human-Machine Safety Settings and the end point reduce speed limit will always functioning.</p> <p>[Solution]</p> <ol style="list-style-type: none"> <li>1. Check the safety tool point position set.</li> <li>2. Check the payloads, speed setting and limit.</li> <li>3. Jog or hand guide the robot back the limited space manually.</li> </ol>

ErrorSuggestion0000C25C	<p>4. Trigger Robot Stick Reset button or user connected Reset input to leave Recovery mode and back to normal operation.</p> <p>[Cause] Robot safety tool point/end-point speed exceeds reduced speed limit</p> <p>[Caution] The robot will enter Recovery mode. Soft Axis safety limit and the trigger of Human-Machine Safety Settings will be disabled.</p> <p>[Additional Explanation] While the robot under Recovery mode, the safety parameters will follow Human-Machine Safety Settings and the end point reduce speed limit will always functioning.</p> <p>[Solution]</p> <ol style="list-style-type: none"> <li>1. Check the safety tool point position set.</li> <li>2. Check the payloads, speed setting and limit.</li> <li>3. Jog or hand guide the robot back the limited space manually.</li> <li>4. Trigger Robot Stick Reset button or user connected Reset input to leave Recovery mode and back to normal operation.</li> </ol>
ErrorSuggestion0000C25D	<p>[Cause] Robot safety tool point/end-point speed exceeds reduced speed limit</p> <p>[Caution] The robot will enter Recovery mode. Soft Axis safety limit and the trigger of Human-Machine Safety Settings will be disabled.</p> <p>[Additional Explanation] While the robot under Recovery mode, the safety parameters will follow Human-Machine Safety Settings and the end point reduce speed limit will always functioning.</p> <p>[Solution]</p> <ol style="list-style-type: none"> <li>1. Check the safety tool point position set.</li> <li>2. Check the payloads, speed setting and limit.</li> <li>3. Jog or hand guide the robot back the limited space manually.</li> <li>4. Trigger Robot Stick Reset button or user connected Reset input to leave Recovery mode and back to normal operation.</li> </ol>
ErrorSuggestion0000C25E	<p>[Cause] Robot safety tool point/end-point speed exceeds reduced speed limit</p> <p>[Caution] The robot will enter Recovery mode. Soft Axis safety limit and the trigger of Human-Machine Safety Settings will be disabled.</p> <p>[Additional Explanation] While the robot under Recovery mode, the safety parameters will follow Human-Machine Safety Settings and the end point reduce speed limit will always functioning.</p> <p>[Solution]</p> <ol style="list-style-type: none"> <li>1. Check the safety tool point position set.</li> <li>2. Check the payloads, speed setting and limit.</li> <li>3. Jog or hand guide the robot back the limited space manually.</li> <li>4. Trigger Robot Stick Reset button or user connected Reset input to leave Recovery mode and back to normal operation.</li> </ol>
ErrorSuggestion0000C25F	<p>[Cause] Robot safety tool point/end-point speed exceeds reduced speed limit</p> <p>[Caution] The robot will enter Recovery mode. Soft Axis safety limit and the trigger of Human-Machine Safety Settings will be disabled.</p> <p>[Additional Explanation] While the robot under Recovery mode, the safety parameters will follow Human-Machine Safety Settings and the end point reduce speed limit will always functioning.</p> <p>[Solution]</p> <ol style="list-style-type: none"> <li>1. Check the safety tool point position set.</li> <li>2. Check the payloads, speed setting and limit.</li> <li>3. Jog or hand guide the robot back the limited space manually.</li> <li>4. Trigger Robot Stick Reset button or user connected Reset input to leave Recovery mode and back to normal operation.</li> </ol>

ErrorSuggestion0000C261	<p>[Cause] Robot joint torque exceeds limit</p> <p>[Caution] The robot will enter Recovery mode. Soft Axis safety limit and the trigger of Human-Machine Safety Settings will be disabled.</p> <p>[Additional Explanation] While the robot under Recovery mode, the safety parameters will follow Human-Machine Safety Settings and the end point reduce speed limit will always functioning.</p> <p>[Solution]</p> <ol style="list-style-type: none"> <li>1. Check the safety tool point position set.</li> <li>2. Check the payloads, speed setting and limit.</li> <li>3. Jog or hand guide the robot back the limited space manually.</li> <li>4. Trigger Robot Stick Reset button or user connected Reset input to leave Recovery mode and back to normal operation.</li> </ol>
ErrorSuggestion0000C262	<p>[Cause] Robot joint torque exceeds limit</p> <p>[Caution] The robot will enter Recovery mode. Soft Axis safety limit and the trigger of Human-Machine Safety Settings will be disabled.</p> <p>[Additional Explanation] While the robot under Recovery mode, the safety parameters will follow Human-Machine Safety Settings and the end point reduce speed limit will always functioning.</p> <p>[Solution]</p> <ol style="list-style-type: none"> <li>1. Check the safety tool point position set.</li> <li>2. Check the payloads, speed setting and limit.</li> <li>3. Jog or hand guide the robot back the limited space manually.</li> <li>4. Trigger Robot Stick Reset button or user connected Reset input to leave Recovery mode and back to normal operation.</li> </ol>
ErrorSuggestion0000C263	<p>[Cause] Robot joint torque exceeds limit</p> <p>[Caution] The robot will enter Recovery mode. Soft Axis safety limit and the trigger of Human-Machine Safety Settings will be disabled.</p> <p>[Additional Explanation] While the robot under Recovery mode, the safety parameters will follow Human-Machine Safety Settings and the end point reduce speed limit will always functioning.</p> <p>[Solution]</p> <ol style="list-style-type: none"> <li>1. Check the safety tool point position set.</li> <li>2. Check the payloads, speed setting and limit.</li> <li>3. Jog or hand guide the robot back the limited space manually.</li> <li>4. Trigger Robot Stick Reset button or user connected Reset input to leave Recovery mode and back to normal operation.</li> </ol>
ErrorSuggestion0000C264	<p>[Cause] Robot joint torque exceeds limit</p> <p>[Caution] The robot will enter Recovery mode. Soft Axis safety limit and the trigger of Human-Machine Safety Settings will be disabled.</p> <p>[Additional Explanation] While the robot under Recovery mode, the safety parameters will follow Human-Machine Safety Settings and the end point reduce speed limit will always functioning.</p> <p>[Solution]</p> <ol style="list-style-type: none"> <li>1. Check the safety tool point position set.</li> <li>2. Check the payloads, speed setting and limit.</li> <li>3. Jog or hand guide the robot back the limited space manually.</li> <li>4. Trigger Robot Stick Reset button or user connected Reset input to leave Recovery mode and back to normal operation.</li> </ol>
ErrorSuggestion0000C265	<p>[Cause] Robot joint torque exceeds limit</p> <p>[Caution] The robot will enter Recovery mode. Soft Axis safety limit and the trigger of Human-Machine Safety Settings will be disabled.</p>

ErrorSuggestion0000C266	<p>[Additional Explanation] While the robot under Recovery mode, the safety parameters will follow Human-Machine Safety Settings and the end point reduce speed limit will always functioning.</p> <p>[Solution]</p> <ol style="list-style-type: none"> <li>1. Check the safety tool point position set.</li> <li>2. Check the payloads, speed setting and limit.</li> <li>3. Jog or hand guide the robot back the limited space manually.</li> <li>4. Trigger Robot Stick Reset button or user connected Reset input to leave Recovery mode and back to normal operation.</li> </ol>
ErrorSuggestion0000C271	<p>[Cause] Robot joint torque exceeds limit</p> <p>[Caution] The robot will enter Recovery mode. Soft Axis safety limit and the trigger of Human-Machine Safety Settings will be disabled.</p> <p>[Additional Explanation] While the robot under Recovery mode, the safety parameters will follow Human-Machine Safety Settings and the end point reduce speed limit will always functioning.</p> <p>[Solution]</p> <ol style="list-style-type: none"> <li>1. Check the safety tool point position set.</li> <li>2. Check the payloads, speed setting and limit.</li> <li>3. Jog or hand guide the robot back the limited space manually.</li> <li>4. Trigger Robot Stick Reset button or user connected Reset input to leave Recovery mode and back to normal operation.</li> </ol>
ErrorSuggestion0000C272	<p>[Cause] TCP/elbow force exceeds limit</p> <p>[Caution] The robot will enter Recovery mode. Soft Axis safety limit and the trigger of Human-Machine Safety Settings will be disabled.</p> <p>[Additional Explanation] While the robot under Recovery mode, the safety parameters will follow Human-Machine Safety Settings and the end point reduce speed limit will always functioning.</p> <p>[Solution]</p> <ol style="list-style-type: none"> <li>1. Check the TCP position set.</li> <li>2. Check the payloads, speed setting and limit.</li> <li>3. Jog or hand guide the robot back the limited space manually.</li> <li>4. Trigger Robot Stick Reset button or user connected Reset input to leave Recovery mode and back to normal operation.</li> </ol>
ErrorSuggestion0000C273	<p>[Cause] TCP/elbow force exceeds limit</p> <p>[Caution] The robot will enter Recovery mode. Soft Axis safety limit and the trigger of Human-Machine Safety Settings will be disabled.</p> <p>[Additional Explanation] While the robot under Recovery mode, the safety parameters will follow Human-Machine Safety Settings and the end point reduce speed limit will always functioning.</p> <p>[Solution]</p> <ol style="list-style-type: none"> <li>1. Check the TCP position set.</li> <li>2. Check the payloads, speed setting and limit.</li> <li>3. Jog or hand guide the robot back the limited space manually.</li> <li>4. Trigger Robot Stick Reset button or user connected Reset input to leave Recovery mode and back to normal operation.</li> </ol>

ErrorSuggestion0000C280

1. Check the TCP position set.
2. Check the payloads, speed setting and limit.
3. Jog or hand guide the robot back the limited space manually.
4. Trigger Robot Stick Reset button or user connected Reset input to leave Recovery mode and back to normal operation.

[Cause] User connected bumping sensor input triggered

[Caution] The robot will enter Recovery mode. Soft Axis safety limit and the trigger of Human-Machine Safety Settings will be disabled.

[Additional Explanation] While the robot under Recovery mode, the safety parameters will follow Human-Machine Safety Settings and the end point reduce speed limit will always functioning.

[Solution]

1. Untrigger the bumping sensor input port.
2. Trigger Robot Stick Reset button or user connected Reset input to leave Recovery mode and back to normal operation.

ErrorSuggestion0000CD00

[Cause]

1. The external safety device input discrepancy.

[Caution]

1. Check if the wire on the external safety device port(s) is securely fastened.

[Precaution]

When the situation above is triggered, the robot will enter STO, which means the power is cut off after the robot speed has been decreased to zero. If there are any payloads on the TCP, without drive power, the TCP will tend to drop a little bit before coming to a complete stop. Please be aware of the tool (payload) colliding with objects in close proximity.

1. Ensure that all wires connected to the external safety device port(s) are securely connected.

[Solution]

1. If discrepancy happens in external safety device input:
  - a. Check and fix the wire connection on control box.
  - b. Trigger the corresponded safety IO port for more than one seconds and than untrigger.
  - c. Trigger Robot Stick Reset button or user connected Reset input to power on the robot.
  - d. If under Manual Mode, it requires the trigger of Enabling Switch function to unbrake the robot.

ErrorSuggestion0000CD01

[Cause]

1. The external safety device input discrepancy.

[Caution]

1. Check if the wire on the external safety device port(s) is securely fastened.

[Precaution]

When the situation above is triggered, the robot will enter STO, which means the power is cut off after the robot speed has been decreased to zero. If there are any payloads on the TCP, without drive power, the TCP will tend to drop a little bit before coming to a complete stop. Please be aware of the tool (payload) colliding with objects in close proximity.

1. Ensure that all wires connected to the external safety device port(s) are securely connected.

[Solution]

1. If discrepancy happens in external safety device input:
  - a. Check and fix the wire connection on control box.
  - b. Trigger the corresponded safety IO port for more than one seconds and than untrigger.
  - c. Trigger Robot Stick Reset button or user connected Reset input to power on the robot.
  - d. If under Manual Mode, it requires the trigger of Enabling Switch function to release the brake of the robot.



ErrorSuggestion0000CD02

[Cause]

1. The external safety device input discrepancy.

[Caution]

1. Check if the wire on the external safety device port(s) is securely fastened.

[Precaution]

When the situation above is triggered, the robot will enter STO, which means the power is cut off after the robot speed has been decreased to zero. If there are any payloads on the TCP, without drive power, the TCP will tend to drop a little bit before coming to a complete stop. Please be aware of the tool (payload) colliding with objects in close proximity.

1. Ensure that all wires connected to the external safety device port(s) are securely connected.

[Solution]

1. If discrepancy happens in external safety device input:
  - a. Check and fix the wire connection on control box.
  - b. Trigger the corresponded safety IO port for more than one seconds and than untrigger.
  - c. Trigger Robot Stick Reset button or user connected Reset input to power on the robot.
  - d. If under Manual Mode, it requires the trigger of Enabling Switch function to release the brake of the robot.

ErrorSuggestion0000CD03

[Cause]

1. The external safety device input discrepancy.

[Caution]

1. Check if the wire on the external safety device port(s) is securely fastened.

[Precaution]

When the situation above is triggered, the robot will enter STO, which means the power is cut off after the robot speed has been decreased to zero. If there are any payloads on the TCP, without drive power, the TCP will tend to drop a little bit before coming to a complete stop. Please be aware of the tool (payload) colliding with objects in close proximity.

1. Ensure that all wires connected to the external safety device port(s) are securely connected.

[Solution]

1. If discrepancy happens in external safety device input:
  - a. Check and fix the wire connection on control box.
  - b. Trigger the corresponded safety IO port for more than one seconds and than untrigger.
  - c. Trigger Robot Stick Reset button or user connected Reset input to power on the robot.
  - d. If under Manual Mode, it requires the trigger of Enabling Switch function to release the brake of the robot.

ErrorSuggestion0000CD04

[Cause]

1. The external safety device input discrepancy.

[Caution]

1. Check if the wire on the external safety device port(s) is securely fastened.

[Precaution]

When the situation above is triggered, the robot will enter STO, which means the power is cut off after the robot speed has been decreased to zero. If there are any payloads on the TCP, without drive power, the TCP will tend to drop a little bit before coming to a complete stop. Please be aware of the tool (payload) colliding with objects in close proximity.

1. Ensure that all wires connected to the external safety device port(s) are securely connected.

[Solution]

1. If discrepancy happens in external safety device input:
  - a. Check and fix the wire connection on control box.
  - b. Trigger the corresponded safety IO port for more than one seconds and than untrigger.



ErrorSuggestion0000CD05

- c. Trigger Robot Stick Reset button or user connected Reset input to power on the robot.
- d. If under Manual Mode, it requires the trigger of Enabling Switch function to release the brake of the robot.

[Cause]

- 1. The external safety device input discrepancy.

[Caution]

- 1. Check if the wire on the external safety device port(s) is securely fastened.

[Precaution]

When the situation above is triggered, the robot will enter STO, which means the power is cut off after the robot speed has been decreased to zero. If there are any payloads on the TCP, without drive power, the TCP will tend to drop a little bit before coming to a complete stop. Please be aware of the tool (payload) colliding with objects in close proximity.

- 1. Ensure that all wires connected to the external safety device port(s) are securely connected.

[Solution]

- 1. If discrepancy happens in external safety device input:
  - a. Check and fix the wire connection on control box.
  - b. Trigger the corresponded safety IO port for more than one seconds and than untrigger.
  - c. Trigger Robot Stick Reset button or user connected Reset input to power on the robot.
  - d. If under Manual Mode, it requires the trigger of Enabling Switch function to release the brake of the robot.

ErrorSuggestion0000CD06

[Cause]

- 1. The external safety device input discrepancy.

[Caution]

- 1. Check if the wire on the external safety device port(s) is securely fastened.

[Precaution]

When the situation above is triggered, the robot will enter STO, which means the power is cut off after the robot speed has been decreased to zero. If there are any payloads on the TCP, without drive power, the TCP will tend to drop a little bit before coming to a complete stop. Please be aware of the tool (payload) colliding with objects in close proximity.

- 1. Ensure that all wires connected to the external safety device port(s) are securely connected.

[Solution]

- 1. If discrepancy happens in external safety device input:
  - a. Check and fix the wire connection on control box.
  - b. Trigger the corresponded safety IO port for more than one seconds and than untrigger.
  - c. Trigger Robot Stick Reset button or user connected Reset input to power on the robot.
  - d. If under Manual Mode, it requires the trigger of Enabling Switch function to release the brake of the robot.

ErrorSuggestion0000CD07

[Cause]

- 1. The external safety device input discrepancy.

[Caution]

- 1. Check if the wire on the external safety device port(s) is securely fastened.

[Precaution]

When the situation above is triggered, the robot will enter STO, which means the power is cut off after the robot speed has been decreased to zero. If there are any payloads on the TCP, without drive power, the TCP will tend to drop a little bit before coming to a complete stop. Please be aware of the tool (payload) colliding with objects in close proximity.

- 1. Ensure that all wires connected to the external safety device port(s) are securely connected.

[Solution]

- 1. If discrepancy happens in external safety device input:
  - a. Check and fix the wire connection on control box.

	<ul style="list-style-type: none"> <li>b. Trigger the corresponded safety IO port for more than one seconds and than untrigger.</li> <li>c. Trigger Robot Stick Reset button or user connected Reset input to power on the robot.</li> <li>d. If under Manual Mode, it requires the trigger of Enabling Switch function to release the brake of the robot.</li> </ul>
ErrorSuggestion0000CD08	<p>[Hardware Failure]</p> <ol style="list-style-type: none"> <li>1. Please try to restart the robot.</li> <li>2. If the restart is invalid, please contact the original purchase or third-party designated maintenance units.</li> </ol>
ErrorSuggestion0000CD09	<p>[Hardware Failure]</p> <ol style="list-style-type: none"> <li>1. Please try to restart the robot.</li> <li>2. If the restart is invalid, please contact the original purchase or third-party designated maintenance units.</li> </ol>
ErrorSuggestion0000CD0A	<p>[Hardware Failure]</p> <ol style="list-style-type: none"> <li>1. Please try to restart the robot.</li> <li>2. If the restart is invalid, please contact the original purchase or third-party designated maintenance units.</li> </ol>
ErrorSuggestion0000CD0B	<p>[Hardware Failure]</p> <ol style="list-style-type: none"> <li>1. Please try to restart the robot.</li> <li>2. If the restart is invalid, please contact the original purchase or third-party designated maintenance units.</li> </ol>
ErrorSuggestion0000CD0C	<p>[Hardware Failure]</p> <ol style="list-style-type: none"> <li>1. Please try to restart the robot.</li> <li>2. If the restart is invalid, please contact the original purchase or third-party designated maintenance units.</li> </ol>
ErrorSuggestion0000CD0D	<p>[Hardware Failure]</p> <ol style="list-style-type: none"> <li>1. Please try to restart the robot.</li> <li>2. If the restart is invalid, please contact the original purchase or third-party designated maintenance units.</li> </ol>
ErrorSuggestion0000CD0E	<p>[Hardware Failure]</p> <ol style="list-style-type: none"> <li>1. Please try to restart the robot.</li> <li>2. If the restart is invalid, please contact the original purchase or third-party designated maintenance units.</li> </ol>
ErrorSuggestion0000CD0F	<p>[Hardware Failure]</p> <ol style="list-style-type: none"> <li>1. Please try to restart the robot.</li> <li>2. If the restart is invalid, please contact the original purchase or third-party designated maintenance units.</li> </ol>
ErrorSuggestion0000CD10	<p>[Hardware Failure]</p> <ol style="list-style-type: none"> <li>1. Please try to restart the robot.</li> <li>2. If the restart is invalid, please contact the original purchase or third-party designated maintenance units.</li> </ol>
ErrorSuggestion0000CD11	<p>[Hardware Failure]</p> <ol style="list-style-type: none"> <li>1. Please try to restart the robot.</li> <li>2. If the restart is invalid, please contact the original purchase or third-party designated maintenance units.</li> </ol>
ErrorSuggestion0000CD12	<p>[Hardware Failure]</p> <ol style="list-style-type: none"> <li>1. Please try to restart the robot.</li> <li>2. If the restart is invalid, please contact the original purchase or third-party designated maintenance units.</li> </ol>
ErrorSuggestion00008000	<p>[Cause]Dual channel Robot Stick ESTOP Port do not trigger at the same time.</p> <p>[Caution]Check if the wire on the port(s) for emergency stop is securely fastened.</p> <p>[Additional Explanations] In order to comply with safety regulations, the emergency button external ports were designed to be simultaneously triggered.</p> <p>[Solution]1. Plug the wire back in to the port.</p> <ol style="list-style-type: none"> <li>2. Press (and or release) the emergency stop button. <ul style="list-style-type: none"> <li>a. The robot mode indicator lights will blink red.</li> <li>b. After a few seconds, the robot mode indicator will blink light blue, indicating the robot has entered safe startup mode.</li> <li>c. Long press STOP button for few seconds and release to back to robot normal operational mode.</li> </ul> </li> </ol> <p>Ensure that all wires connected to the emergency stop ports are securely connected.</p>

ErrorSuggestion00008001	<p>[Cause]Dual channel User Connected ESTOP Input Port do not trigger at the same time.</p> <p>[Caution]Check if the wire on the extension port(s) for emergency stop is securely fastened.</p> <p>[Additional Explanations] In order to comply with safety regulations, the emergency button external ports were designed to be simultaneously triggered.</p> <p>[Solution]1. Plug the wire back in to the port.</p> <p>2. Press (and or release) the emergency stop button.</p> <ol style="list-style-type: none"> <li>a. The robot mode indicator lights will blink red.</li> <li>b. After a few seconds, the robot mode indicator will blink light blue, indicating the robot has entered safe startup mode.</li> <li>c. Long press STOP button for few seconds and release to back to robot normal operational mode.</li> </ol> <p>Ensure that all wires connected to the User Connected ESTOP Input Port are securely connected.</p>
ErrorSuggestion00008002	<p>[Cause] Dual channel User Connected External Safeguard Input Port do not trigger at the same time.</p> <p>[Caution] Check if the wire on the external port(s) is securely fastened.</p> <p>[Solution]1. Plug the wire back in to the port.</p> <p>2. Trigger (and or untrigger) the external safety input device.</p> <ol style="list-style-type: none"> <li>a. The robot mode indicator lights will blink red.</li> <li>b. After a few seconds, the robot mode indicator will blink light blue, indicating the robot has entered safe startup mode.</li> <li>c. Long press STOP button for few seconds and release to back to robot normal operation mode.</li> </ol> <p>Ensure that all wires connected to the User Connected External Safeguard Input Port are securely connected.</p>
ErrorSuggestion00008003	<p>[Cause] Dual channel User Connected External Safeguard Input Port for Human – Machine Safety Settings do not trigger at the same time.</p> <p>[Caution] Check if the wire on the external port(s) is securely fastened.</p> <p>[Solution]1. Plug the wire back in to the port.</p> <p>2. Trigger (and or untrigger) the external safety input device.</p> <ol style="list-style-type: none"> <li>a. The robot mode indicator lights will blink red.</li> <li>b. After a few seconds, the robot mode indicator will blink light blue, indicating the robot has entered safe startup mode.</li> <li>c. Long press STOP button for few seconds and release to back to robot normal operation mode.</li> </ol> <p>Ensure that all wires connected to the User Connected External Safeguard Input Port for Human – Machine Safety Settings are securely connected.</p>
ErrorSuggestion00008004	<p>[Cause] Dual channel User Connected Enabling Device Input Port do not trigger at the same time.</p> <p>[Caution] Check if the wire on the external port(s) is securely fastened.</p> <p>[Solution]1. Plug the wire back in to the port.</p> <p>2. Trigger (and or untrigger) the external safety input device.</p> <ol style="list-style-type: none"> <li>a. The robot mode indicator lights will blink red.</li> <li>b. After a few seconds, the robot mode indicator will blink light blue, indicating the robot has entered safe startup mode.</li> <li>c. Long press STOP button for few seconds and release to back to robot normal operation mode.</li> </ol> <p>Ensure that all wires connected to User Connected Enabling Device Input Port are securely connected.</p>
ErrorSuggestion00008005	<p>[Cause] Dual channel User Connected ESTOP Input Port without Robot ESTOP Output do not trigger at the same time.</p> <p>[Caution] Check if the wire on the external port(s) is securely fastened.</p> <p>[Solution]1. Plug the wire back in to the port.</p> <p>2. Press (and or release) the emergency stop button.</p> <ol style="list-style-type: none"> <li>a. The robot mode indicator lights will blink red.</li> <li>b. After a few seconds, the robot mode indicator will blink light blue, indicating the robot has entered</li> </ol>

	safe startup mode.
	<ul style="list-style-type: none"> <li>c. Long press STOP button for few seconds and release to back to robot normal operational mode.</li> </ul> <p>Ensure that all wires connected to User Connected ESTOP Input Port without Robot ESTOP Output are securely connected.</p>
ErrorSuggestion00008006	<p>[Cause] Dual channel safeguard port do not trigger at the same time.</p> <p>[Caution] Check if the wire on the external port(s) is securely fastened.</p> <p>[Solution]1. Plug the wire back in to the port.</p> <p>2. Trigger (and or untrigger) the external safety input device.</p> <p>Ensure that all wires connected to Safeguard Port are securely connected.</p>
ErrorSuggestion00008007	<p>[Cause] Dual channel safeguard port do not trigger at the same time.</p> <p>[Caution] Check if the wire on the external port(s) is securely fastened.</p> <p>[Solution]1. Plug the wire back in to the port.</p> <p>2. Trigger (and or untrigger) the external safety input device.</p> <p>Ensure that all wires connected to Safeguard Port are securely connected.</p>
ErrorSuggestion00008008	<p>[Cause] Dual channel Robot ESTOP Output Port do not trigger at the same time.</p> <p>[Caution] Fault(s) occurs in the internal system.</p> <p>[Solution]1. Restart the robot.</p> <p>2. If the problem still occur, contact a qualified service engineer for further analysis</p>
ErrorSuggestion00008009	<p>[Cause] Dual channel User Connected External Safeguard Output Port do not trigger at the same time.</p> <p>[Caution] Fault(s) occurs in the internal system.</p> <p>[Solution]1. Restart the robot.</p> <p>2. If the problem still occur, contact a qualified service engineer for further analysis</p>
ErrorSuggestion0000800A	<p>[Cause] Dual channel User Connected External Safeguard Output Port for Human – Machine Safety Settings do not trigger at the same time.</p> <p>[Caution] Fault(s) occurs in the internal system.</p> <p>[Solution]1. Restart the robot.</p> <p>2. If the problem still occur, contact a qualified service engineer for further analysis</p>
ErrorSuggestion0000800B	<p>[Cause] Dual channel Robot Internal Protective Stop Output Port do not trigger at the same time.</p> <p>[Caution] Fault(s) occurs in the internal system.</p> <p>[Solution]1. Restart the robot.</p> <p>2. If the problem still occur, contact a qualified service engineer for further analysis</p>
ErrorSuggestion0000800C	<p>[Cause] Dual channel Robot Encoder Standstill Output Port do not trigger at the same time.</p> <p>[Caution] Fault(s) occurs in the internal system.</p> <p>[Solution]1. Restart the robot.</p> <p>2. If the problem still occur, contact a qualified service engineer for further analysis</p>
ErrorSuggestion0000FF00	Please try the other motion path.
ErrorSuggestion0000FF01	<p>[Cause] Payload and speed are over specification</p> <p>[Caution]</p> <ol style="list-style-type: none"> <li>1. Check if the TCP setting of the current tool is correct</li> <li>2. Check if the payload setting on each motion node is correct</li> <li>3. Check if the speed of the current project is too fast</li> </ol> <p>[Additional Explanation] Momentum is defined as mass (tool + payload) x TCP speed</p> <p>[Additional Explanation] This error is not likely happen if both payload and speed is within specification</p> <p>[Solution]</p> <ol style="list-style-type: none"> <li>1. Trigger Robot Stick Reset button or user connected Reset input to leave Recovery mode and back to normal operation.</li> <li>2. Modified the TCP settings or motion settings; or remove the payload first.</li> </ol>

ErrorSuggestion0000FF02

3. Check the payloads, speed setting and limit. Make sure both payload and speed is within specification.
4. Run the project again; if this error still occurs, contact a qualified service engineer for further analysis.

[Cause]

1. Current motion of the robot is too fast
2. Hardware issue

[Caution]

1. Check if the TCP setting of the current tool is correct
2. Check if the payload setting on each motion node is correct
3. Check if the speed of the current project is too fast

[Additional Explanation] This error does not likely happen since other error code should be triggered first, such as 0x00000049, 0x00000053, 0x00000054

[Solution]

1. Trigger Robot Stick Reset button or user connected Reset input to leave Recovery mode and back to normal operation.
2. Modified the TCP settings or motion settings; or remove the payload first.
3. Check the payloads, speed setting and limit. Make sure both payload and speed is within specification.
4. Run the project again; if this error still occurs, contact a qualified service engineer for further analysis.

ErrorSuggestion0000FF03

Please adjust the Collaboration space.

ErrorSuggestion0000FF04

[Cause] The robot detects a TCP speed which exceeds the limit of the safety settings.

[Caution]

1. Check and make sure the safety tool speed limit is suitable.
2. Make sure the settings of TCP used are correct, especially the pose of TCP.
3. Check if the issued point is PTP on motion setting.

[Additional Explanation] If the robot moves under the circumstances of singularity (both internal and external) with PTP on motion setting, that may easily cause this error.

1. Avoid postures or motion paths near singularities.
2. Decrease the speed if you want to keep the posture or motion path smooth.
3. Make sure the force limit value of the Safety Settings is suitable in both Manual/Auto Mode and collaborative workspace.

[Solution]

To restore the robot from error status:

1. Trigger Robot Stick Reset button or user connected Reset input to back to normal operation.

ErrorSuggestion0000FF05

[Cause] The robot detects an exceeding TCP force

[Caution]

1. Check if the robot will collide with anything.
2. Check and make sure the safety tool force limit is suitable.
3. Make sure the settings of all TCP used are correct, including the pose of TCP, Mass, Mass Center Frame, Principal Moments of Inertia.
4. Make sure the payload setting is correct on every motion related node of the flow, e.g. Point, Move, Pallet, etc.

[Precaution] Tools with a mass center frame far from the flange will add large external torques onto the robot. Without the correct TCP settings (including, TCP pose, Mass, Mass Center Frame, Principal Moments of Inertia), the servo system would mistake this for a error.

[Additional Explanation]

The result of TCP forces achieved is by calculations. This calculation will be dysfunctional when the robot passes through the singularity zone, and will mistakenly trigger this error.

1. Avoid postures or motion paths near singularities.
2. Decrease the speed if you want to keep the posture or motion path smooth.

ErrorSuggestion0000FF06	<p>3. Make sure the force limit value of the Safety Settings is suitable in both Manual/Auto Mode and collaborative workspace.</p> <p>[Solution]</p> <p>To restore the robot from error status:</p> <ol style="list-style-type: none"> <li>1. Trigger Robot Stick Reset button or user connected Reset input to back to normal operation.</li> </ol> <p>[Cause]Joint 1 Position exceeds the value of the safety setting threshold.</p> <p>[Caution]1. Check that the safety threshold angle of the axis is appropriate.</p> <ol style="list-style-type: none"> <li>2. Check that the project flow has not set a position that the TM Robot cannot reach (for example, using a TM5 to run TM12 project).</li> </ol> <p>[Solution]To restore the robot from error status:</p> <ol style="list-style-type: none"> <li>1. Press the STOP button on the robot stick, or</li> <li>2. Press the FREE button</li> </ol> <ol style="list-style-type: none"> <li>1. Set the safety threshold to a more suitable value.</li> <li>2. Revise the project flow.</li> </ol>
ErrorSuggestion0000FF07	<p>[Cause] Joint 1 Speed exceeds the safety limit.</p> <p>[Caution]</p> <ol style="list-style-type: none"> <li>1. Check the safety limit is appropriate.</li> <li>2. Check the line speed setting.</li> </ol> <p>[Additional Explanation]</p> <ol style="list-style-type: none"> <li>1. Make sure the safety limits are suitable for current application</li> <li>2. Make sure the motion of the project would not trigger this error</li> </ol> <p>[Solution]</p>
ErrorSuggestion0000FF08	<p>To restore the robot from error status:</p> <ol style="list-style-type: none"> <li>1. Trigger Robot Stick Reset button or user connected Reset input to back to normal operation.</li> </ol> <p>[Cause] Joint 1 Torque exceeds the safety limit.</p> <p>This may be caused by:</p> <ol style="list-style-type: none"> <li>1. Improper payload settings</li> <li>2. a collision has occurred</li> <li>3. The brake is abnormal</li> </ol> <p>[Caution]</p> <ol style="list-style-type: none"> <li>1. Check that the payload setting is correct</li> <li>2. Check if there has been a collision</li> <li>3. Check whether the joint brake is abnormal</li> </ol> <p>[Additional Explanation]</p> <ol style="list-style-type: none"> <li>1. Make sure the payload setting or payload used is suitable</li> <li>2. Make sure the safety limits are suitable for current application</li> <li>3. Assess the working environment, avoid any violent collision onto the robot</li> </ol> <p>[Solution]</p>
ErrorSuggestion0000FF09	<p>To restore the robot from error status:</p> <ol style="list-style-type: none"> <li>1. Trigger Robot Stick Reset button or user connected Reset input to back to normal operation.</li> </ol> <p>[Cause]Joint 2 Position exceeds the value of the safety setting threshold.</p> <p>[Caution]1. Check that the safety threshold angle of the axis is appropriate.</p> <ol style="list-style-type: none"> <li>2. Check that the project flow has not set a position that the TM Robot cannot reach (for example, using a TM5 to run TM12 project).</li> </ol> <p>[Solution]To restore the robot from error status:</p> <ol style="list-style-type: none"> <li>1. Press the STOP button on the robot stick, or</li> </ol>

ErrorSuggestion0000FF0A	<p>2. Press the FREE button</p> <ol style="list-style-type: none"> <li>1. Set the safety threshold to a more suitable value.</li> <li>2. Revise the project flow.</li> </ol> <p>[Cause] Joint 2 Speed exceeds the safety limit.</p> <p>[Caution]</p> <ol style="list-style-type: none"> <li>1. Check the safety limit is appropriate.</li> <li>2. Check the line speed setting.</li> </ol> <p>[Additional Explanation]</p> <ol style="list-style-type: none"> <li>1. Make sure the safety limits are suitable for current application</li> <li>2. Make sure the motion of the project would not trigger this error</li> </ol> <p>[Solution]</p> <p>To restore the robot from error status:</p> <ol style="list-style-type: none"> <li>1. Trigger Robot Stick Reset button or user connected Reset input to back to normal operation.</li> </ol>
ErrorSuggestion0000FF0B	<p>[Cause] Joint 2 Torque exceeds the safety limit.</p> <p>This may be caused by:</p> <ol style="list-style-type: none"> <li>1. Improper payload settings</li> <li>2. a collision has occurred</li> <li>3. The brake is abnormal</li> </ol> <p>[Caution]</p> <ol style="list-style-type: none"> <li>1. Check that the payload setting is correct</li> <li>2. Check if there has been a collision</li> <li>3. Check whether the joint brake is abnormal</li> </ol> <p>[Additional Explanation]</p> <ol style="list-style-type: none"> <li>1. Make sure the payload setting or payload used is suitable</li> <li>2. Make sure the safety limits are suitable for current application</li> <li>3. Assess the working environment, avoid any violent collision onto the robot</li> </ol> <p>[Solution]</p> <p>To restore the robot from error status:</p> <ol style="list-style-type: none"> <li>1. Trigger Robot Stick Reset button or user connected Reset input to back to normal operation.</li> </ol>
ErrorSuggestion0000FF0C	<p>[Cause] Joint 3 Position exceeds the value of the safety setting threshold.</p> <p>[Caution]</p> <ol style="list-style-type: none"> <li>1. Check that the safety threshold angle of the axis is appropriate.</li> <li>2. Check that the project flow has not set a position that the TM Robot cannot reach (for example, using a TM5 to run TM12 project).</li> </ol> <p>[Solution]</p> <p>To restore the robot from error status:</p> <ol style="list-style-type: none"> <li>1. Press the STOP button on the robot stick, or</li> <li>2. Press the FREE button</li> </ol> <ol style="list-style-type: none"> <li>1. Set the safety threshold to a more suitable value.</li> <li>2. Revise the project flow.</li> </ol>
ErrorSuggestion0000FF0D	<p>[Cause] Joint 3 Speed exceeds the safety limit.</p> <p>[Caution]</p> <ol style="list-style-type: none"> <li>1. Check the safety limit is appropriate.</li> <li>2. Check the line speed setting.</li> </ol> <p>[Additional Explanation]</p> <ol style="list-style-type: none"> <li>1. Make sure the safety limits are suitable for current application</li> <li>2. Make sure the motion of the project would not trigger this error</li> </ol> <p>[Solution]</p>

ErrorSuggestion0000FF0E

To restore the robot from error status:

1. Trigger Robot Stick Reset button or user connected Reset input to back to normal operation.

[Cause] Joint 3 Torque exceeds the safety limit.

This may be caused by:

1. Improper payload settings
2. a collision has occurred
3. The brake is abnormal

[Caution]

1. Check that the payload setting is correct
2. Check if there has been a collision
3. Check whether the joint brake is abnormal

[Additional Explanation]

1. Make sure the payload setting or payload used is suitable
2. Make sure the safety limits are suitable for current application
3. Assess the working environment, avoid any violent collision onto the robot

[Solution]

To restore the robot from error status:

1. Trigger Robot Stick Reset button or user connected Reset input to back to normal operation.

ErrorSuggestion0000FF0F

[Cause] Joint 4 Position exceeds the value of the safety setting threshold.

[Caution] 1. Check that the safety threshold angle of the axis is appropriate.

2. Check that the project flow has not set a position that the TM Robot cannot reach (for example, using a TM5 to run TM12 project).

[Solution] To restore the robot from error status:

1. Press the STOP button on the robot stick, or
2. Press the FREE button
1. Set the safety threshold to a more suitable value.
2. Revise the project flow.

ErrorSuggestion0000FF10

[Cause] Joint 4 Speed exceeds the safety limit.

[Caution]

1. Check the safety limit is appropriate.
2. Check the line speed setting.

[Additional Explanation]

1. Make sure the safety limits are suitable for current application
2. Make sure the motion of the project would not trigger this error

[Solution]

To restore the robot from error status:

1. Trigger Robot Stick Reset button or user connected Reset input to back to normal operation.

ErrorSuggestion0000FF11

[Cause] Joint 4 Torque exceeds the safety limit.

This may be caused by:

1. Improper payload settings
2. a collision has occurred
3. The brake is abnormal

[Caution]

1. Check that the payload setting is correct
2. Check if there has been a collision
3. Check whether the joint brake is abnormal



ErrorSuggestion0000FF12	<p>[Additional Explanation]</p> <ol style="list-style-type: none"> <li>1. Make sure the payload setting or payload used is suitable</li> <li>2. Make sure the safety limits are suitable for current application</li> <li>3. Assess the working environment, avoid any violent collision onto the robot</li> </ol> <p>[Solution]</p> <p>To restore the robot from error status:</p> <ol style="list-style-type: none"> <li>1. Trigger Robot Stick Reset button or user connected Reset input to back to normal operation.</li> </ol> <p>[Cause]Joint 5 Position exceeds the value of the safety setting threshold.</p> <p>[Caution]1. Check that the safety threshold angle of the axis is appropriate.</p> <ol style="list-style-type: none"> <li>2. Check that the project flow has not set a position that the TM Robot cannot reach (for example, using a TM5 to run TM12 project).</li> </ol>
ErrorSuggestion0000FF13	<p>[Solution]To restore the robot from error status:</p> <ol style="list-style-type: none"> <li>1. Press the STOP button on the robot stick, or</li> <li>2. Press the FREE button</li> </ol> <ol style="list-style-type: none"> <li>1. Set the safety threshold to a more suitable value.</li> <li>2. Revise the project flow.</li> </ol> <p>[Cause] Joint 5 Speed exceeds the safety limit.</p> <p>[Caution]</p> <ol style="list-style-type: none"> <li>1. Check the safety limit is appropriate.</li> <li>2. Check the line speed setting.</li> </ol>
ErrorSuggestion0000FF14	<p>[Additional Explanation]</p> <ol style="list-style-type: none"> <li>1. Make sure the safety limits are suitable for current application</li> <li>2. Make sure the motion of the project would not trigger this error</li> </ol> <p>[Solution]</p> <p>To restore the robot from error status:</p> <ol style="list-style-type: none"> <li>1. Trigger Robot Stick Reset button or user connected Reset input to back to normal operation.</li> </ol> <p>[Cause] Joint 5 Torque exceeds the safety limit.</p> <p>This may be caused by:</p> <ol style="list-style-type: none"> <li>1. Improper payload settings</li> <li>2. a collision has occurred</li> <li>3. The brake is abnormal</li> </ol> <p>[Caution]</p> <ol style="list-style-type: none"> <li>1. Check that the payload setting is correct</li> <li>2. Check if there has been a collision</li> <li>3. Check whether the joint brake is abnormal</li> </ol>
ErrorSuggestion0000FF15	<p>[Additional Explanation]</p> <ol style="list-style-type: none"> <li>1. Make sure the payload setting or payload used is suitable</li> <li>2. Make sure the safety limits are suitable for current application</li> <li>3. Assess the working environment, avoid any violent collision onto the robot</li> </ol> <p>[Solution]</p> <p>To restore the robot from error status:</p> <ol style="list-style-type: none"> <li>1. Trigger Robot Stick Reset button or user connected Reset input to back to normal operation.</li> </ol> <p>[Cause]Joint 6 Position exceeds the value of the safety setting threshold.</p> <p>[Caution]1. Check that the safety threshold angle of the axis is appropriate.</p> <ol style="list-style-type: none"> <li>2. Check that the project flow has not set a position that the TM Robot cannot reach (for example, using a TM5 to run TM12 project).</li> </ol>

	<p>[Solution]To restore the robot from error status:</p> <ol style="list-style-type: none"> <li>1. Press the STOP button on the robot stick, or</li> <li>2. Press the FREE button</li> </ol>
ErrorSuggestion0000FF16	<p>1. Set the safety threshold to a more suitable value.</p> <p>2. Revise the project flow.</p> <p>[Cause] Joint 6 Speed exceeds the safety limit.</p> <p>[Caution]</p> <ol style="list-style-type: none"> <li>1. Check the safety limit is appropriate.</li> <li>2. Check the line speed setting.</li> </ol> <p>[Additional Explanation]</p> <ol style="list-style-type: none"> <li>1. Make sure the safety limits are suitable for current application</li> <li>2. Make sure the motion of the project would not trigger this error</li> </ol>
ErrorSuggestion0000FF17	<p>[Solution]</p> <p>To restore the robot from error status:</p> <ol style="list-style-type: none"> <li>1. Trigger Robot Stick Reset button or user connected Reset input to back to normal operation.</li> </ol> <p>[Cause] Joint 6 Torque exceeds the safety limit.</p> <p>This may be caused by:</p> <ol style="list-style-type: none"> <li>1. Improper payload settings</li> <li>2. a collision has occurred</li> <li>3. The brake is abnormal</li> </ol> <p>[Caution]</p> <ol style="list-style-type: none"> <li>1. Check that the payload setting is correct</li> <li>2. Check if there has been a collision</li> <li>3. Check whether the joint brake is abnormal</li> </ol> <p>[Additional Explanation]</p> <ol style="list-style-type: none"> <li>1. Make sure the payload setting or payload used is suitable</li> <li>2. Make sure the safety limits are suitable for current application</li> <li>3. Assess the working environment, avoid any violent collision onto the robot</li> </ol> <p>[Solution]</p> <p>To restore the robot from error status:</p> <ol style="list-style-type: none"> <li>1. Trigger Robot Stick Reset button or user connected Reset input to back to normal operation.</li> </ol>
ErrorSuggestion0000FF18	Please check if safety threshold of the seventh axis angle is appropriate.
ErrorSuggestion0000FF19	Please check if safety threshold of the seventh axis speed is appropriate.
ErrorSuggestion0000FF1A	<ol style="list-style-type: none"> <li>1. Check whether the Payload setting is correct</li> <li>2. Check whether there is a collision during the seventh axis</li> <li>3. Check whether the seventh axis brake is abnormal</li> </ol>
ErrorSuggestion00013880	Mathematical operation failed! Please contact the original purchase of the manufacturer or a third party designated maintenance unit.
ErrorSuggestion00013881	Mathematical operation failed! Please contact the original purchase of the manufacturer or a third party designated maintenance unit.
ErrorSuggestion00013882	Mathematical operation failed! Please contact the original purchase of the manufacturer or a third party designated maintenance unit.
ErrorSuggestion00013883	Mathematical operation failed! Please contact the original purchase of the manufacturer or a third party designated maintenance unit.
ErrorSuggestion00013884	Mathematical operation failed! Please contact the original purchase of the manufacturer or a third party designated maintenance unit.





















ErrorSuggestion00014FF9	Mathematical operation failed! Please contact the original purchase of the manufacturer or a third party designated maintenance unit.
ErrorSuggestion00014FFA	Mathematical operation failed! Please contact the original purchase of the manufacturer or a third party designated maintenance unit.
ErrorSuggestion00014FFB	Mathematical operation failed! Please contact the original purchase of the manufacturer or a third party designated maintenance unit.
ErrorSuggestion00014FFC	Mathematical operation failed! Please contact the original purchase of the manufacturer or a third party designated maintenance unit.
ErrorSuggestion00014FFD	Mathematical operation failed! Please contact the original purchase of the manufacturer or a third party designated maintenance unit.
ErrorSuggestion000153D8	Mathematical operation failed! Please contact the original purchase of the manufacturer or a third party designated maintenance unit.
ErrorSuggestion000153D9	Mathematical operation failed! Please contact the original purchase of the manufacturer or a third party designated maintenance unit.
ErrorSuggestion000153DA	Mathematical operation failed! Please contact the original purchase of the manufacturer or a third party designated maintenance unit.
ErrorSuggestion000153DB	Mathematical operation failed! Please contact the original purchase of the manufacturer or a third party designated maintenance unit.
ErrorSuggestion000153DC	Mathematical operation failed! Please contact the original purchase of the manufacturer or a third party designated maintenance unit.
ErrorSuggestion000153DD	Mathematical operation failed! Please contact the original purchase of the manufacturer or a third party designated maintenance unit.
ErrorSuggestion000153DE	Mathematical operation failed! Please contact the original purchase of the manufacturer or a third party designated maintenance unit.
ErrorSuggestion000153DF	Mathematical operation failed! Please contact the original purchase of the manufacturer or a third party designated maintenance unit.
ErrorSuggestion000153E0	Mathematical operation failed! Please contact the original purchase of the manufacturer or a third party designated maintenance unit.
ErrorSuggestion000153E1	Mathematical operation failed! Please contact the original purchase of the manufacturer or a third party designated maintenance unit.
ErrorSuggestion000153E2	Mathematical operation failed! Please contact the original purchase of the manufacturer or a third party designated maintenance unit.
ErrorSuggestion000153E3	Mathematical operation failed! Please contact the original purchase of the manufacturer or a third party designated maintenance unit.
ErrorSuggestion000157C0	Mathematical operation failed! Please contact the original purchase of the manufacturer or a third party designated maintenance unit.
ErrorSuggestion000157C1	Mathematical operation failed! Please contact the original purchase of the manufacturer or a third party designated maintenance unit.
ErrorSuggestion00020000	[Cause] The robot cannot detect or recognize the camera. [Caution] 1. Check if there is a camera icon in the vision job page. 2. Check whether the USB connection of the camera is broken on the control box or inside the robot arm. [Precaution] Causes a camera malfunction and VISION job\task will not be available. [Precaution] Importing the project within the vision job to a non-vision robot will also cause this error. [Solution] Refer to the related service manual for proper USB plugin methods. Ensure that all USB cables are securely connected to the camera and the control box.

ErrorSuggestion00020001	The camera is busy when the flow try to use it. Check the flow where user may misuse multi-thread flow to use the sample camera.
ErrorSuggestion00020002	Unexpected errors occurred. Reboot the robot and try to use fewer or simpler vision jobs. If it keeps happening, please contact your support windows.
ErrorSuggestion00020003	[Cause] The connection between camera and robot is unstable. [Caution] 1. Check the USB connection to the camera and control box is secure. 2. Check if the USB slots are overloaded. [Precaution] Causes a camera malfunction and VISION job/task will not be available. [Precaution] The USB cable's transmission signal would become weak gradually because of the normal consumption of wire. [Additional Explanations] Signal attenuation cause by too many USB cable plug on the control box. Sometimes, if the signal attenuation became worse it will cause the error "0x00020000 Camera NOT found " [Solution] Please refer to the service manual which related Robot arm which would teach you how to dismantle and plug the USB cable properly. Please refer to the service manual which related control box which would teach you how to plug the USB cable properly. Please check the USB slots are overloaded on the control box and please plug out the USB which is not required. Please regularly check if the USB Cable connected to the camera and control box are all fine.
ErrorSuggestion00020004	The vision job is not compatible to the current version of HMI.
ErrorSuggestion00020005	[Cause] Dongle key is not detected while edit the corresponding function on a project or run that project [Caution] Check if the dongle is plugged onto the Control Box [Solution] 1. Press STOP button on the robot stick to restore from error status 2. Connect the corresponding Dongle onto the Control box and run the project again 3. Run the project again; if this error still occurs, contact a qualified service engineer for further analysis Make sure having the corresponding Dongle key plugged before running or editing the project with license functions
ErrorSuggestion00020006	This message is only for TM's production line.
ErrorSuggestion00020007	Error occurs in the flow of vision's designer. Try to re-edit the vision job. If it keeps happening, please contact our official windows.
ErrorSuggestion00020008	[Cause] Vision job cannot be found during executing the VISION node [Caution] Check if the vision job is exist or not. [Solution] 1. Trigger Robot Stick Reset button or user connected Reset input 2. Re-create the vision job 3. Make sure the vision job is exist before executes the project
ErrorSuggestion00020009	[Cause] The same camera is simultaneously accessed by multiple threads. [Caution] Check if there are multi- threads using the same camera while running the project. [Solution] 1. Trigger Robot Stick Reset button or user connected Reset input 2. Make sure a camera is being used by only one thread
ErrorSuggestion0002000A	This job can only be run on X64 platform
ErrorSuggestion0002000B	Servoing and Vision-IO threads conflict
ErrorSuggestion0002000C	Error occurs in saving vision actioner result to storage. Please check and try to reset storage.
ErrorSuggestion0002000D	External HTTP setting missing. Please create or select other setting
ErrorSuggestion0002000E	AI model missing. Please create or select other model

ErrorSuggestion0002000F	Please confirm that the image exists in the path folder
ErrorSuggestion00020010	The 3D camera parameters do not match the camera settings, please edit the task again
ErrorSuggestion00020011	Please avoid continuous execution of servo tasks in the process
ErrorSuggestion00020012	Please install the GPU driver in the correct path and check that the GPU device is installed correctly
ErrorSuggestion00020013	Please re-select the correct AI computing device
ErrorSuggestion00020014	Please confirm whether the GPU related configuration is set correctly
ErrorSuggestion00020015	Please go to TM official website to download and import the same GPU patch as the current TMflow version
ErrorSuggestion00020016	Please check is there are more than one IO trigger job in project
ErrorSuggestion00020017	Please check is vision execution time too long
ErrorSuggestion00020018	Please check is camera using different trigger mode
ErrorSuggestion00020019	This AI model version is not supported. Please check the TMflow version.
ErrorSuggestion0002001A	This AI model does not support processing in the device with this operating system.
ErrorSuggestion0002001B	Please edit again and save the job.
ErrorSuggestion00030001	[Cause] Points setting error during creating a plane for Operation Space [Caution] Check if more than 2 of the three points of the plane are the same [Additional Explanation] a plane could only be created by 3 different points [Solution] 1. Click on the OK button on the pop up windows. 2. Reset the 3 points in following steps: Setting > Operation Space > Select project name of plane > Set Point Before creating a plane, make sure the 3 points are set well, and should not be repeated.
ErrorSuggestion00030002	[Cause] Points setting error during creating a cube for Operation Space [Caution] Check if more than 2 of the four points of the cube are the same [Additional Explanation] a cube could only be created by 4 different points [Solution] 1. Click on the OK button on the pop up windows. 2. Reset the 4 points in following steps: Setting > Operation Space > Select project name of cube > Set Point Before creating a cube, make sure the 4 points are set well, and should not be repeated.
ErrorSuggestion00030003	[Cause] The system fails to combine this plane with other planes. [Caution] Check if the three points set by the user when adding this plane, the center point of the circle falls on the outside of plane. [Solution] Re-create a plane which is suitable Check if the three points are set up when adding this plane, the center point of the circle falls on the inside of plane.
ErrorSuggestion00030004	[Cause] The system fails to combine this stop plane with other planes. [Caution] Check if the three points set by the user when adding this stop plane, the center point of the circle falls on the outside of plane. [Solution] Re-create a stop plane which is suitable Check if the three points are set up when adding this stop plane, the center point of the circle falls on the inside of plane.
ErrorSuggestion00030005	Re-Build Safety Space
ErrorSuggestion00030006	Please contact the original purchase of the manufacturer or a third party designated maintenance unit.
ErrorSuggestion00030007	N/a
ErrorSuggestion00031000	[Cause] The 3D Viewer function has been terminated [Caution] Check any 3D viewer on TMflow (such as Setting/Controller) if it is functional

	[Additional Explanation] This error does not likely happen unless there is a software issue
	[Solution]
	1. Export the log
	2. Have the robot power cycling to see if this error still occurs
	3. Report to the service engineer with the log file
ErrorSuggestion00031001	Please contact the original purchase of the manufacturer or a third party designated maintenance unit.
ErrorSuggestion00031002	Please contact the original purchase of the manufacturer or a third party designated maintenance unit.
ErrorSuggestion00031003	Please contact the original purchase of the manufacturer or a third party designated maintenance unit.
ErrorSuggestion00031004	Please contact the original purchase of the manufacturer or a third party designated maintenance unit.
ErrorSuggestion00031005	Invalid point for collision check node
ErrorSuggestion00031006	Invalid parameter for collision check node
ErrorSuggestion00031007	Over angle limit for collision check node
ErrorSuggestion00040000	1. Please try to restart the robot. 2. If the restart is invalid, please contact the original purchase or third-party designated maintenance units.
ErrorSuggestion00040001	1. Please backup the HMI Log. 2. Please contact the original purchase of the manufacturer or a third party designated maintenance unit.
ErrorSuggestion00040002	1. Please backup the HMI Log. 2. Please contact the original purchase of the manufacturer or a third party designated maintenance unit.
ErrorSuggestion00040003	1. Please backup the HMI Log. 2. Please contact the original purchase of the manufacturer or a third party designated maintenance unit.
ErrorSuggestion00040004	1. Please backup the HMI Log. 2. Please contact the original purchase of the manufacturer or a third party designated maintenance unit.
ErrorSuggestion00040005	[Cause] The HMI found that a unexpected exception error. [Caution]
	1. Check if there is other error message describe the location of the issue node
	2. Check if there is other error message describe more detail of this issue
	[Additional Explanation] This error usually happens if there is a unexpected software issue
	[Solution]
	1. Export the log file and the project file
	2. Contact a qualified service engineer
ErrorSuggestion00040006	1. Please backup the HMI Log. 2. Please contact the original purchase of the manufacturer or a third party designated maintenance unit.
ErrorSuggestion00040007	[Cause] Emergency Stop function triggered, and the power of the robot is cut off. HMI can't connect to the robot. [Caution] Check if Emergency Stop function triggered:
	1. The ESTOP button of the Robot Stick is pressed.
	2. The ESTOP wire of the control box is not connected.
	Check if the LED light of the robot is turn off.
	[Additional Explanation] This error usually appears as a popped up message on HMI
	[Additional Explanation] This error usually happens because the power of the robot is cut off by Emergency Stop function triggered while doing the one of the following cases:
	1. When open and close the camera IO LED, the HMI will pop up a window message 「Robot is not connected」
	2. In Project, click the "Step Run" button, the HMI will pop up a window message 「Set Speed Fail :Robot is not connected」
	3. Leave the project and enter the project again, the HMI will pop up a window message 「error code : Robot is not connected」
	4. etc.
	[Solution]

ErrorSuggestion00040008  
ErrorSuggestion00040009  
ErrorSuggestion0004000A

1. If Emergency Stop function triggered:
  - a. Restore the Emergency Stop button.
  - b. Trigger Robot Stick Reset button or user connected Reset input to power on the robot.
  - c.If under Manual Mode, it requires the trigger of Enabling Switch function to release the brake of the robot.
2. If Safety IO port discrepancy occurred:
  - a. Check and fix the wire connection on control box.
  - b. Trigger the corresponded safety IO port for more than one seconds and than untrigger.
  - c. Trigger Robot Stick Reset button or user connected Reset input to power on the robot.
  - d.If under Manual Mode, it requires the trigger of Enabling Switch function to release the brake of the robot.

Make sure the robot is connected while using HMI

Please confirm user permissions.

Please check whether the user account, password are correct.

[Cause] Emergency Stop function triggered, and the power of the robot is cut off. HMI can't connect to the robot.

[Caution] Check if Emergency Stop function triggered:

1. The ESTOP button of the Robot Stick is pressed.
2. The ESTOP wire of the control box is not connected.

Check if the LED light of the robot is turn off.

[Additional Explanation] This error usually appears as a popped up message in HMI

[Additional Explanation] This error usually happens because the power of the robot is cut off by ESTOP mode triggered.

1. When operator the controller ,the HMI will pop up a window message 「System fault: Lock Robot{{0}}」

[Solution]

1. If Emergency Stop function triggered:
  - a. Restore the Emergency Stop button.
  - b. Trigger Robot Stick Reset button or user connected Reset input to power on the robot.
  - c.If under Manual Mode, it requires the trigger of Enabling Switch function to release the brake of the robot.
2. If Safety IO port discrepancy occurred:
  - a. Check and fix the wire connection on control box.
  - b. Trigger the corresponded safety IO port for more than one seconds and than untrigger.
  - c. Trigger Robot Stick Reset button or user connected Reset input to power on the robot.
  - d.If under Manual Mode, it requires the trigger of Enabling Switch function to release the brake of the robot.

Make sure the robot is connected while using HMI

ErrorSuggestion0004000B

1. Please reboot robot and try to set it again.

2. If the restart is invalid, please contact the original purchase or third-party designated maintenance units.

ErrorSuggestion0004000C

1. Please check whether the setting of TCP is correct.

2. If the restart is invalid, please contact the original purchase or third-party designated maintenance units.

ErrorSuggestion0004000D

1. Please backup the HMI Log.

2. Please contact the original purchase of the manufacturer or a third party designated maintenance unit.

ErrorSuggestion0004000E

Please check whether the TCP settings are correct and complete.

ErrorSuggestion0004000F

[Cause] The project is broken or does not exists.

[Caution] Check the project list again whether the project is not existing.

[Precaution] This error would only show on the pop up window, not in the HMI log.

[Solution]

1. Click on the OK button on the pop up window.
2. Make sure project is exported successfully before unplug the USB drive.

ErrorSuggestion00040010

Please check whether the component exists or is damaged.



ErrorSuggestion00040011	<p>[Cause] The current node has not been set up correctly</p> <p>[Caution]</p> <ol style="list-style-type: none"> <li>1. Check if the issued node is grey in color which means it is still in offline mode</li> <li>2. Check if the setting of the current node is abnormal</li> </ol> <p>[Additional Explanation] Motion related node built by TMflow Editor has no position information which need further set up on a robot</p> <p>[Solution]</p> <ol style="list-style-type: none"> <li>1. Trigger Robot Stick Reset button or user connected Reset input to restore the error status</li> <li>2. Complete the setup of the current node</li> <li>3. Make sure all motion related nodes built from TMflow Editor has complete settings before step run</li> <li>4. Make sure all nodes of the project has been set up correctly</li> </ol>
ErrorSuggestion00040012	Please check whether the coordinate system settings are correct and complete.
ErrorSuggestion00040013	<p>[Cause] When the TCP data is lost, or the servo check and the TCP data exchange error occurred.</p> <p>[Caution] Check if the TCP Setting UI could open that TCP</p> <p>[Solution]</p> <ol style="list-style-type: none"> <li>1. Import the project or TCP data again or reset the TCP settings</li> <li>2. Make sure the USB devices and import process are stable during importing project and TCP data</li> <li>3. Check if the TCP data is existed before uses it</li> </ol>
ErrorSuggestion00040014	<p>[Cause] System has detected invalid settings from certain node</p> <p>[Caution]</p> <ol style="list-style-type: none"> <li>1. Check the error message followed and locate the issued node</li> <li>2. Check if the issued node is grey in color which means it is still in offline mode</li> <li>3. Check if the setting of any nodes is abnormal</li> </ol> <p>[Additional Explanation] Motion related node built by TMflow Editor has no position information which need further set up on a robot</p> <p>[Solution]</p> <ol style="list-style-type: none"> <li>1. Trigger Robot Stick Reset button or user connected Reset input to restore the error status</li> <li>2. Complete the setup of the current node</li> <li>3. Make sure all motion related nodes built from TMflow Editor has complete settings before project run</li> <li>4. Make sure all nodes of the project has been set up correctly</li> </ol>
ErrorSuggestion00040015	<p>[Cause] System has detected a dysfunction on the CPU Fan</p> <p>[Caution] Check if there is any weird noise coming from the Control box</p> <p>[Additional Explanation] If CPU fan is being stuck or the power cable of the fan is loosen, this error might happen</p> <p>[Solution(End User)]</p> <ol style="list-style-type: none"> <li>1. Contact a qualified service engineer for further analysis</li> <li>2. Make sure the robot is installed on a stable platform</li> </ol> <p>[Solution(Robot Maintenance Staff)]</p> <p>Follow Troubleshooting Guide "Insufficient speed of CPU fan" for troubleshooting.</p>
ErrorSuggestion00040016	<p>[Cause] Input the invalid value in the field in user setting.</p> <p>[Caution]Check if</p> <ol style="list-style-type: none"> <li>1. The Field of setting is empty</li> <li>2. The format type of value in the field is invalid</li> </ol> <p>[Additional Explanation]</p> <p>This error usually appears as a pop up window when using,</p> <ol style="list-style-type: none"> <li>1. HMI Setting Page</li> <li>2. Project Flow</li> </ol>



	[Solution]
	1. Click OK and close the pop up window
	2. Make sure the value in the field is valid during setting
ErrorSuggestion00040017	Please check whether the coordinate system settings are correct and complete.
ErrorSuggestion00040018	[Cause] The base is currently used by other nodes, deleting this base will trigger this error
	[Caution] Check if the base is currently used by any nodes
	[Additional Explanations] The base is currently used by other nodes (POINTS, NEW BASE, etc.) , deleting this base will trigger this error
	[Additional Explanation] This error code will only appears on HMI as a pop up window
	[Solution]
	1. Click on the OK button on the pop up window.
	2. Make sure the base is not being used by any nodes before deleting it
ErrorSuggestion00040019	1. Check that the Point is present.
	2. Check that the Point setting is abnormal.
ErrorSuggestion0004001A	1. Please backup the HMI Log.
	2. Please contact the original purchase of the manufacturer or a third party designated maintenance unit.
ErrorSuggestion0004001B	1. Please backup the HMI Log.
	2. Please contact the original purchase of the manufacturer or a third party designated maintenance unit.
ErrorSuggestion0004001C	[Cause] There is no nodes connected to the Start Node in the Project Flow
	[Caution] Check if there is no nodes connected to the Start Node in the Project Flow
	[Solution]
	1. Trigger Robot Stick Reset button or user connected Reset input to restore the error status
	2. Connect the next process Node to the Start Node
	Be careful when editing Project Flow
ErrorSuggestion0004001D	Please check whether the coordinate system settings are correct and complete.
ErrorSuggestion0004001E	[Cause] User account has already been login by other client device
	[Caution] Check if someone else has already login with the same account
	[Additional Explanation] This error is not likely happens, instead, 0x00040009 (Log In/Out failed) is more often.
	[Solution]
	1. Click OK and close the pop up window
	2. Make sure you are the only one use this account while logging in
ErrorSuggestion0004001F	[Cause] Another account gets the Control permission
	[Caution] Check if there is someone else get the Control permission with another account
	[Additional Explanation] This could only happen if multiple accounts try to get the Control permission at the same time (nearly)
	[Additional Explanation] Usually, if one account has already get the Control ownership, the Get Control button on other accounts would disabled
	[Solution]
	1. Have the current Control permission account release the control first
	2. Try getting the Control permission again
	Make sure only one account would get the Control permission at once
ErrorSuggestion00040020	Please confirm user permissions.
ErrorSuggestion00040021	[Cause] If user edit a exist base which using "by pointing 3 points" function in Base Manager without manual teaching and click OK directly, it might cause this error.
	[Caution] In "Build a Base by 3 points" page, if user did not teach the one of three axis direction in the both option "Point on X axis" and "Point on Surface".
	[Additional Explanations] User must to choose and teach one of three axis direction(X,Y,Z) in the settings "Point on

	X axis" and "Point on Surface".
	[Solution]
	1. Click on the OK button on the pop up windows.
	2. Check the base is set correctly by manual operation in the "by pointing 3 points" function page .
ErrorSuggestion00040022	[Cause] Teach points in Compliance or Touch Stop node are not able to generate a legal motion
	[Caution] In Compliance or Touch Stop Node, check if the teach points are at the same position or impossible to generate a legal motion
	[Precaution] This error would only show the "Calculation failed" on the pop up window, not in the HMI log.
	[Solution]
	1. Click on the OK button on the pop up windows.
	2. Make sure the teach points are all suitable and correct.
ErrorSuggestion00040023	[Cause] Teach points in Compliance or Touch Stop node are not able to generate a legal linear motion
	[Caution] In Compliance or Touch Stop Node, check if the teach points are at the same position or impossible to generate a legal linear motion
	[Precaution] This error would only show the "Calculation failed" on the pop up window, not in the HMI log.
	[Solution]
	1. Click on the OK button on the pop up windows.
	2. Make sure the teach points are all suitable and correct.
ErrorSuggestion00040024	1. Please backup the HMI Log.
	2. Please contact the original purchase of the manufacturer or a third party designated maintenance unit.
ErrorSuggestion00040025	Please check whether the SystimeFile.ini is correct.
ErrorSuggestion00040026	1. Please backup the HMI Log.
	2. Please contact the original purchase of the manufacturer or a third party designated maintenance unit.
ErrorSuggestion00040027	[Cause] Project cannot be executed under AUTO MODE when USB device plugged in the control box.
	[Caution] Check if there is no USB devices plugged on the control box
	[Additional Explanation] This error usually happens because the user forgets to remove the USB device from the control box before run the project under AUTO MODE.
	[Solution]
	1. Trigger Robot Stick Reset button or user connected Reset input to restore the error status
	2. Remove the USB device from the control box
	3. Make sure all USB devices are removed from the control box before the project executes under AUTO MODE.
ErrorSuggestion00040028	Please check whether the project is running.
ErrorSuggestion00040029	Please check whether the project is editing.
ErrorSuggestion0004002A	[Cause] The target project is not found while running function WARP
	[Caution] Please check if the target project selected in WARP function node is still exist
	[Solution]
	If the target project of the WARP function node has been deleted or renamed, please reset or erase the node
	Please remind when deleting or renaming a project if it is related to other project with WARP function
ErrorSuggestion0004002B	[Cause] WARP project failed
	[Caution] Check if the target project of the WARP node is damaged or deleted
	[Additional Explanation] This project are not likely to be damaged, possibly because of software issue
	[Solution]
	1. Trigger Robot Stick Reset button or user connected Reset input to restore the error status
	2. Export both project files and log file
	3. Contact a qualified service engineer for further analysis
	Make sure the project used by WARP node exists

ErrorSuggestion0004002C	<p>[Cause] Unexpected software issue during project compiling</p> <p>[Caution] Check if there is any error messages followed</p> <p>[Additional Explanation] This error occurs if and only if there is a unexpected issue on software</p> <p>[Solution]</p> <ol style="list-style-type: none"> <li>1. Trigger Robot Stick Reset button or user connected Reset input to restore the error status</li> <li>2. Export the project file and log file</li> <li>3. Contact a qualified service engineer for further analysis</li> </ol>
ErrorSuggestion0004002D	<p>[Cause] System detected a error on Project Flow while the it is running</p> <p>[Caution]</p> <ol style="list-style-type: none"> <li>1. Check the message with this error code; it should specify which node has error</li> <li>2. Check if there is another error code also occurs</li> </ol> <p>[Additional Explanation] There are lot of cases for this error, such as:</p> <ol style="list-style-type: none"> <li>1. Any variables being used in the Project is deleted.</li> <li>2. Incorrect settings on Pallet node, Circle node, etc.</li> <li>3. Expressions or settings of If node, Waitfor node, Gateway node are incorrect</li> <li>4. etc.</li> </ol> <p>[Solution]</p> <ol style="list-style-type: none"> <li>1. Trigger Robot Stick Reset button or user connected Reset input to restore the error status</li> </ol> <p>Follow the message of the error code and correct the error</p> <ol style="list-style-type: none"> <li>1. Be careful when deleting variables in Variable Manager.</li> <li>2. Study and have a full understanding on Node Function, make sure the settings are correct</li> </ol>
ErrorSuggestion0004002E	<p>[Cause] Fail to get control of the robot during the project running.</p> <p>[Caution]</p> <ol style="list-style-type: none"> <li>1. Check if the robot is controlled by other user</li> <li>2. Check if the robot is running a project</li> <li>3. Check if the robot has been released control</li> </ol> <p>[Additional Explanation] This error usually appears as a popped up message in HMI</p> <p>[Additional Explanation] This error usually happens when user wants to use the robot (Project Editing or Controller) while it is running a project.</p> <p>[Solution]</p> <ol style="list-style-type: none"> <li>1. Click on the OK button on the pop up windows.</li> <li>2. Stop the running project through pressing the Stop button on Robot Stick</li> <li>3. Recover to get control of the robot by following steps in HMI : Log in --&gt; Get Control</li> <li>4. Check if the robot is controlled by other user before using the robot.</li> <li>5. Don't release control of the robot during project-running.</li> </ol>
ErrorSuggestion00040030	Please check whether Force-Torque sensor device is exist within Smart Insert Node
ErrorSuggestion00040031	<p>[Cause] Robot detect the Force-Torque sensor occurred error during opening COM port.</p> <p>[Caution] Check if the COM port is correct in the Force-Torque sensor devices settings page.</p> <p>[Precaution] This error would only show on the pop up window, not in the HMI log.</p> <p>[Solution]</p> <ol style="list-style-type: none"> <li>1. Click on the OK and close the pop window</li> <li>2. Make sure the COM port setting is correct before use the Force-Torque sensor.</li> </ol>
ErrorSuggestion00040032	Please check Modbus device setting are correct
ErrorSuggestion00040033	Please retry delete Modbus device
ErrorSuggestion00040034	Please check Force-Torque sensor is workable
ErrorSuggestion00040035	<p>[Cause] Robot detect the Force-Torque sensor does not respond.</p> <p>[Caution] Check if the COM port cable is loose.</p>

ErrorSuggestion00040036	<p>[Additional Explanation] While the Force-Torque sensor is working, if the COM port cable is loose, it would cause this error.</p> <p>[Solution]</p> <ol style="list-style-type: none"> <li>1. Re-Plug the COM port cable on the robot.</li> <li>2. Make sure the COM port cable is stable during robot and Force-Torque sensor are working.</li> </ol> <p>[Cause] The issued Point node built by TMFlow Editor has not been completed yet</p> <p>[Caution] Check if the issued Point node is grey in color which means it is still in offline mode</p> <p>[Additional Explanation] Point node built by TMFlow Editor has no position information which need further set up on a robot</p> <p>[Solution]</p> <ol style="list-style-type: none"> <li>1. Trigger Robot Stick Reset button or user connected Reset input to restore the error status</li> <li>2. Complete the set up of the point node</li> </ol> <p>Make sure all motion related nodes built from TMflow Editor has complete settings before project run or step run</p>
ErrorSuggestion00040037	<p>[Cause] System memory is not enough</p> <p>[Solution]</p> <p>After restart the robot, if the problem still occurs, contact a qualified service engineer for further analysis.</p>
ErrorSuggestion00040038	<p>[Cause] The current node function created by offline editor has not been complete editing yet</p> <p>[Caution]</p> <ol style="list-style-type: none"> <li>1. Check if the error message following with this error and locate the issue node</li> <li>2. Check if the node is grey in color which means it is in offline mode</li> </ol> <p>[Additional Explanation] Motion related nodes are all in offline mode if they are created by offline editor, user need to complete the settings before usage</p> <p>[Additional Explanation] This error would be trigger during step run or project run</p> <p>[Solution]</p> <ol style="list-style-type: none"> <li>1. Trigger Robot Stick Reset button or user connected Reset input to restore the error status</li> <li>2. Finish the setting of the node on HMI</li> </ol> <p>Make sure all offline nodes are complete setting on HMI</p>
ErrorSuggestion00040039	<p>Please don't use vision keyword as a custom base prefix name</p>
ErrorSuggestion0004003A	<p>[Cause] The payload value set exceeds the maximum payload limit</p> <p>[Caution] Check if the payload value set exceeds the maximum payload limit</p> <p>[Precaution] This error would only show on the pop up window, not in the HMI log.</p> <p>[Solution]</p> <ol style="list-style-type: none"> <li>1. Click on the OK and close the pop window</li> <li>2. Check and make sure the payload value set on a node is within the maximum payload limit</li> </ol>
ErrorSuggestion0004003B	<p>[Cause] TCP loading (including Payload setting) is over limit</p> <p>[Caution]</p> <ol style="list-style-type: none"> <li>1. Check the mass of the TCP</li> <li>2. Check the Payload setting of the related motion node</li> </ol> <p>[Additional Explanation] This error usually shows as a pop up window</p> <p>[Additional Explanation] TCP load is defined as the mass of TCP used plus the Payload setting</p> <p>[Additional Explanation] Instead of motion related nodes, this will also happens on Controller if the Payload setting is over limit</p> <p>[Solution]</p> <ol style="list-style-type: none"> <li>1. Click OK to close the pop up window</li> <li>2. Modified the related settings</li> </ol> <p>Make sure the mass of TCP and Payload setting are within specification</p>
ErrorSuggestion0004003C	<p>NotActive</p>

ErrorSuggestion0004003D	SendDataFail
ErrorSuggestion0004003E	ReceiveDataFail
ErrorSuggestion0004003F	InvalidReturnValue
ErrorSuggestion00040040	GetNoDataFromEmulator
ErrorSuggestion00040041	CheckOptimalSpeed
ErrorSuggestion00040042	Please move robot by free robot
ErrorSuggestion00040043	Please re-record robot point
ErrorSuggestion00040044	Please re-record robot point
ErrorSuggestion00040045	Please modify parameter of node
ErrorSuggestion00040046	Out of Cartesian limits set. Please check if the TCP or elbow is out of the Cartesian limits
ErrorSuggestion00040047	Robot TCP and/or elbow exceeds Cartesian limit
ErrorSuggestion00040048	Please enter another new project name
ErrorSuggestion00040049	Please check leasing key
ErrorSuggestion0004004A	1. Please backup the HMI Log. 2. Please contact the original purchase of the manufacturer or a third party designated maintenance unit.
ErrorSuggestion0004004B	1. Please backup the HMI Log. 2. Please contact the original purchase of the manufacturer or a third party designated maintenance unit.
ErrorSuggestion0004004C	[Cause] The node is invalid for TM AI+ AOI Edge [Solution] Please remove the invalid node for TM AI+ AOI Edge
ErrorSuggestion0004004D	[Cause] Component didn't import correctly. [Solution] Please import the correct component.
ErrorSuggestion0004004E	[Cause] Component setting has a motion command. [Solution] Please check the flow, the component can't work with a motion command.
ErrorSuggestion0004004F	[Cause] Component didn't import correctly. [Solution] Please import the correct component.
ErrorSuggestion00040050	[Cause] External IO device no connection. [Solution] Please check the external IO device function and connection.
ErrorSuggestion00040051	1. Please backup the HMI Log. 2. Please contact the original purchase of the manufacturer or a third party designated maintenance unit.
ErrorSuggestion00040052	[Cause] Could not set key status during Robot Stick unlocking [Solution] 1. Leave Robot Stick unlocking status
ErrorSuggestion00040053	[Cause] Project cannot be executed during system error state [Solution] 1. Remove the error state and try to execute the project again. 2. Restart the robot. 3. If the problem still occur, contact a qualified service engineer for further analysis.
ErrorSuggestion00040054	[Cause] Project cannot be executed if AUT.P port is open [Solution] 1. Close AUT.P port and try to execute the project again. 2. Restart the robot. 3. If the problem still occur, contact a qualified service engineer for further analysis.
ErrorSuggestion00040055	[Cause] Project cannot be edited under AUTO MODE [Solution] 1. Switch to MANUAL MODE and try to edit the project again.
ErrorSuggestion00040056	Project is not running

ErrorSuggestion00040057	[Cause] The gravity sensor failed. [Solution] Please contact the original purchase of the manufacturer or a third party designated maintenance unit.
ErrorSuggestion00040058	Please check project is save from old software version or match software version
ErrorSuggestion00040059	Please check component object need to save from TMflow2.x
ErrorSuggestion00040070	[Cause] Safety checksum mismatch between HMI and safety parameters [Caution] Error in safety parameter's files or values [Additional Explanation] This error may occurred if the safety parameters are improperly modified or the system has faults [Solution] 1. Export the log file 2. Contact a qualified service engineer
ErrorSuggestion00040100	Certification does not match Please download the latest certification file from website to start the installation process. The installation process will not proceed.
ErrorSuggestion00040101	Certification does not match Please request the certification file from the product provider, and put it under TMflow folder located under the installation directory to enable TMflow Editor. Program will be terminated automatically.
ErrorSuggestion00040102	[Warning][User Setting] Host and client versions conflict [Cause] The software version between the robot (host) and Tmflow.exe (client) is not matched [Caution] Check both versions of the robot (host) and the Tmflow.exe on PC (client) if they are matched or not [Precaution] If the versions are not matched, there would be possibly to trigger unexpected errors for certain functions [Solution] 1. Click OK to close the pop up window 2. Make sure both versions of the robot (host) and the Tmflow.exe on PC (client) are matched before login
ErrorSuggestion00040103	[Error][User Setting] Certification does not match. Please get the certification file from the product provider, and put it under TMflow folder located under the installation directory to enable TMflow Editor. Program will be closed automatically. [Cause] Certification for the corresponding HMI does not match [Caution] 1. Check if the certification file on Techman folder is the correct version if this happens on Tmflow.exe 2. Check if the certification file on the USB drive exists or if it is the correct version for HMI update [Solution] 1. Click OK to close the pop up window 2. Replace the file with the correct one Make sure the certification file is correct
ErrorSuggestion00040104	Please download the MD5 file to check the integrity of file.
ErrorSuggestion00040105	Please check or redownload the file.
ErrorSuggestion00040F80	Server initialize failure
ErrorSuggestion00040F81	Server initialize failure, Listener binding error
ErrorSuggestion00040F82	Server initialize failure, Control mode error
ErrorSuggestion00040F83	Server initialize failure, Safety error
ErrorSuggestion00040F84	Server initialize failure, SystemFile error
ErrorSuggestion00040F85	Server initialize failure, Open Vision error
ErrorSuggestion00040F86	Server initialize failure, Open Service error
ErrorSuggestion00040F90	[Cause] 1. Dongle Key missing or been unplugged.

	2. Dongle Key not support current application. [Solution] 1. Please replug the Dongle Key 2. Please contact the original purchase of the manufacturer to confirm your Dongle Key status.
ErrorSuggestion00041000	Communication error, please restart the robot.
ErrorSuggestion00041002	[Cause] Emergency Stop function has been triggered during resuming from a Cat.1 Stop [Caution] 1. Check if the ESTOP button on Robot Stick has been pressed 2. Check if the ESTOP port is being tripped [Additional explanation] 1. Cat.1 Stop usually means ESTOP button on Robot Stick or the ESTOP port on the control box being tripped 2. During the resuming Cat.1 Stop, the EtherCAT communication starts initializing and connecting all slaves, if any Cat.1 Stop are being tripped, power through the robot will cut off which makes the communication can no longer be available. [Solution] 1. Makes sure any Emergency Stop function have been restored, then reboot the robot 2. If the this issue still occurs, contact your service engineer for further analysis Prevent to trigger any Emergency Stop function during the resuming of Cat.1 Stop
ErrorSuggestion00041003	[Cause] Inverse Kinematics failure [Caution] Check if there is any custom base in the current project which may be badly assigned [Additional Explanation] If the inverse kinematics of the target point is failed to be solved, it may trigger this error [Additional Explanation] This may possibly because the custom base used is badly assigned, e.g., 3 points on the same line [Solution] 1. Trigger Robot Stick Reset button or user connected Reset input to restore the error status 2. Export the project file and log file to a qualified service engineer for further analysis Make sure the custom base is well assigned
ErrorSuggestion00041004	1. Please backup the HMI Log. 2. Please contact the original purchase of the manufacturer or a third party designated maintenance unit.
ErrorSuggestion00041005	Communication error, please restart the robot.
ErrorSuggestion00041008	[Cause] The joint is rotating over its degree setting range or the robot's position exceeds the defined working area. [Caution] Check to see if the Joint Position in Safety Settings is set with the correct limits [Precaution] It's would also show which joint is exceeds the limit to notice the user to check the Joint Position setting. [Solution] 1. Trigger Robot Stick Reset button or user connected Reset input to restore the error status 2. Make sure the Joint Position in Safety Settings is set with the correct limits
ErrorSuggestion00041009	Rtx start failure
ErrorSuggestion0004100A	Rtx license failure
ErrorSuggestion0004100B	1. Please backup the HMI Log. 2. Please contact the original purchase of the manufacturer or a third party designated maintenance unit.
ErrorSuggestion0004100C	[Cause] 1. ESTOP button on the Robot Stick has been pressed. 2. The extension port(s) for ESTOP button has been triggered. 3. The external safety device input discrepancy. [Caution] 1. Check that the wire between the Robot Stick and the control box is securely connected and is not triggered. 2. Check if the wire on the extension port(s) for ESTOP button is securely connected and is not triggered.



3. Check if the wire on the external safety device port(s) is securely fastened.

[Precaution]

When the situation above is triggered, the robot will enter STO, which means the power is cut off after the robot speed has been decreased to zero. If there are any payloads on the TCP, without drive power, the TCP will tend to drop a little bit before coming to a complete stop. Please be aware of the tool (payload) colliding with objects in close proximity.

1. Place the Robot Stick or the external ESTOP button in a location to make sure it is reachable while not being pressed accidentally.
2. Check if the Robot Stick cable and the wire connected to the ESTOP ports are firmly connected.
3. Ensure that all wires connected to the external safety device port(s) are securely connected.

[Solution]

1. If the ESTOP button on the Robot Stick has been pressed:
  - a. Release the ESTOP button.
  - b. Trigger Robot Stick Reset button or user connected Reset input to power on the robot.
  - c. If under Manual Mode, it requires the trigger of Enabling Switch function to release the brake of the robot.
2. If a external ESTOP button has been pressed:
  - a. Release the external ESTOP button.
  - b. Trigger Robot Stick Reset button or user connected Reset input to power on the robot.
  - c. If under Manual Mode, it requires the trigger of Enabling Switch function to release the brake of the robot.
3. If discrepancy happens in external safety device input:
  - a. Check and fix the wire connection on control box.
  - b. Trigger the corresponded safety IO port for more than one seconds and than untrigger.
  - c. Trigger Robot Stick Reset button or user connected Reset input to power on the robot.
  - d. If under Manual Mode, it requires the trigger of Enabling Switch function to release the brake of the robot.

ErrorSuggestion00042000

Please check whether the project file is present or damaged.

ErrorSuggestion00042001

1. Please backup the HMI Log.
2. Please contact the original purchase of the manufacturer or a third party designated maintenance unit.

ErrorSuggestion00042002

1. Please backup the HMI Log.
2. Please contact the original purchase of the manufacturer or a third party designated maintenance unit.

ErrorSuggestion00042003

1. Please backup the HMI Log.
2. Please contact the original purchase of the manufacturer or a third party designated maintenance unit.

ErrorSuggestion00042004

1. Please backup the HMI Log.
2. Please contact the original purchase of the manufacturer or a third party designated maintenance unit.

ErrorSuggestion00042005

1. Please backup the HMI Log.
2. Please contact the original purchase of the manufacturer or a third party designated maintenance unit.

ErrorSuggestion00042006

Please check whether the space on the disk is insufficient.

ErrorSuggestion00042007

1. Please backup the HMI Log.
2. Please contact the original purchase of the manufacturer or a third party designated maintenance unit.

ErrorSuggestion00042008

Please check whether the type of variable set in the project is correct.

ErrorSuggestion00042009

1. Please backup the HMI Log.
2. Please contact the original purchase of the manufacturer or a third party designated maintenance unit.

ErrorSuggestion0004200A

1. Please backup the HMI Log.
2. Please contact the original purchase of the manufacturer or a third party designated maintenance unit.

ErrorSuggestion0004200B

Please check whether the variable settings in the project are correct.

ErrorSuggestion0004200C

Please check whether the node settings in the project are correct.

ErrorSuggestion0004200D

Please check whether the vision job is valid.

ErrorSuggestion0004200E

Please check whether the conditions are correct at component exit



ErrorSuggestion0004200F	[Cause] This condition is not match the judgment. [Solution] 1. Check whether conditions are correct at IF/Gateway Case. 2. This condition (IO value or variable) is set at IF/Gateway Case.
ErrorSuggestion00042010	Please check whether the node need to dongle key
ErrorSuggestion00042011	1. Please backup the HMI Log. 2. Please contact the original purchase of the manufacturer or a third party designated maintenance unit.
ErrorSuggestion00042012	Please play the project
ErrorSuggestion00042013	Please wait a moment
ErrorSuggestion00042014	Please check data type or data value of variable is correct
ErrorSuggestion00042015	[Cause] Link to project speed is disabled and the velocity exceeds 250 mm/s. [Caution] Please check the related node of Link to Project Speed, the velocity of Line / PLine should not exceed 250 mm/s [Solution] 1. Velocity or variable value adjusted to less than 250 mm/s 2. Enable "Link to project speed"
ErrorSuggestion00042016	Please check component object has no motion node, and could be used in thread
ErrorSuggestion00042017	Please choice Yes to save project or No to cancel project
ErrorSuggestion00043000	1. Please backup the HMI Log. 2. Please contact the original purchase of the manufacturer or a third party designated maintenance unit.
ErrorSuggestion00043001	Please check whether the SystimeFile.ini is correct.
ErrorSuggestion00043002	1. Please backup the HMI Log. 2. Please contact the original purchase of the manufacturer or a third party designated maintenance unit.
ErrorSuggestion00043003	[Cause] HMI detected that the vision job file is damaged [Caution] Check if the vision job can still be edited through HMI [Additional Explanation] This error is not likely to happen [Additional Explanation] The vision job file might be damaged if there is a software issue [Solution] 1. Trigger Robot Stick Reset button or user connected Reset input to restore the error status 2. Export the project file and log file 3. Contact with a qualified service engineer for further analysis
ErrorSuggestion00043004	[Cause] Vision job file is damaged or deleted [Caution] Check if the vision job can still be edited through HMI [Additional Explanation] This error is not likely to happen [Additional Explanation] The vision job file might be damaged or deleted if there is a software issue [Solution] 1. Trigger Robot Stick Reset button or user connected Reset input to restore the error status 2. Export the project file and log file 3. Contact with a qualified service engineer for further analysis
ErrorSuggestion00043005	1. Please backup the HMI Log. 2. Please contact the original purchase of the manufacturer or a third party designated maintenance unit.
ErrorSuggestion00043006	[Cause] The camera's USB cable connection is loosen during project running. [Additional Explanations] This error is not likely to happen if the robot is not being dismantling illegally [Solution] 1. Export the Logs 2. Contact a qualified service engineer for further analysis. Make sure only the qualified engineer could do any repairing on the hardware

ErrorSuggestion00043007	<ol style="list-style-type: none"> <li>1. Please backup the HMI Log.</li> <li>2. Please contact the original purchase of the manufacturer or a third party designated maintenance unit.</li> </ol>
ErrorSuggestion00043008	<ol style="list-style-type: none"> <li>1. Please backup the HMI Log.</li> <li>2. Please contact the original purchase of the manufacturer or a third party designated maintenance unit.</li> </ol>
ErrorSuggestion00043009	Vision job failed, please check vision job setting.
ErrorSuggestion0004300A	<ol style="list-style-type: none"> <li>1. Please backup the HMI Log.</li> <li>2. Please contact the original purchase of the manufacturer or a third party designated maintenance unit.</li> </ol>
ErrorSuggestion0004300B	<p>[Cause] Calculation of coordinate or arm posture correction occurs error.</p> <p>[Caution] Check the other error code come along with it.</p> <p>[Additional Explanation] This error does not likely happen, low possibility.</p> <p>[Solution]</p> <ol style="list-style-type: none"> <li>1. Trigger Robot Stick Reset button or user connected Reset input to restore the error status</li> <li>2. Run the project again</li> <li>3. If this error still happens, contact a qualified service engineer for further analysis</li> </ol>
ErrorSuggestion0004300C	<ol style="list-style-type: none"> <li>1. Please backup the HMI Log.</li> <li>2. Please contact the original purchase of the manufacturer or a third party designated maintenance unit.</li> </ol>
ErrorSuggestion0004300D	<ol style="list-style-type: none"> <li>1. Please backup the HMI Log.</li> <li>2. Please contact the original purchase of the manufacturer or a third party designated maintenance unit.</li> </ol>
ErrorSuggestion0004300E	<ol style="list-style-type: none"> <li>1. Please backup the HMI Log.</li> <li>2. Please contact the original purchase of the manufacturer or a third party designated maintenance unit.</li> </ol>
ErrorSuggestion0004300F	<p>[Cause] Vision job parameter setting error.</p> <p>[Solution] Please check the flow and correct the parameter.</p>
ErrorSuggestion00043010	<p>[Cause] Vision Job didn't import correctly or data missing.</p> <p>[Solution] Please import the project again or re-edit the vision job.</p>
ErrorSuggestion00043011	<ol style="list-style-type: none"> <li>1. Please backup the HMI Log.</li> <li>2. Please contact the original purchase of the manufacturer or a third party designated maintenance unit.</li> </ol>
ErrorSuggestion00044000	<p>[Cause] Modbus-TCP failed to initialize during power-on</p> <p>[Caution]</p> <ol style="list-style-type: none"> <li>1. Check if the Ethernet cable is loosen</li> <li>2. Check if the Ethernet Connection is not on the general usage LAN port (not those 2 for GigE Camera)</li> </ol> <p>[Additional Explanation] Modbus can only be initialized if the general usage LAN port (not those 2 for GigE Camera) is activated during power-on</p> <p>[Solution]</p> <ol style="list-style-type: none"> <li>1. Connect the general usage LAN with Ethernet</li> <li>2. disabled and then Enable Modbus at Setting/Modbus</li> </ol> <p>Make sure the general usage LAN port (not those 2 for GigE Camera) has been connected to Ethernet before power-on</p>
ErrorSuggestion00044001	Read failed. Please check whether the data is correct.(Head)
ErrorSuggestion00044002	Please contact the original purchase of the manufacturer or a third party designated maintenance unit.
ErrorSuggestion00044003	<p>[Cause] Program exception during Modbus writing</p> <p>[Additional Explanation] This error is not likely happens, only if there is a software issue</p> <p>[Solution]</p> <ol style="list-style-type: none"> <li>1. Export the log and project file</li> <li>2. Contact a qualified service engineer</li> </ol>
ErrorSuggestion00044004	Read address failed. Please check whether the data is correct.
ErrorSuggestion00044005	<p>[Cause] Modbus-RTU failed to initialize during power-on</p> <p>[Caution]</p>

	<ol style="list-style-type: none"> <li>1. Check if the Serial Port cable is loosen</li> <li>2. Check if any RS232 related device is loosen</li> </ol> <p>[Additional Explanation] This usually happens if USB - RS232 convertor is used that a extra COM port is used for Modbus-RTU. If the cable or converter is unplugged, the extra COM-port would be disabled and trigger this error</p> <p>[Solution]</p> <ol style="list-style-type: none"> <li>1. Connect all related RS232 cable or convertor onto the Control Box</li> <li>2. disabled and then Enable Modbus at Setting/Modbus</li> <li>3. It is suggested not to use USB-RS232 convertor for Modbus-RTU</li> <li>4. Make sure cable or convertor used is plug well before power on</li> </ol>
ErrorSuggestion00044200	<p>[Cause] Software process error in fieldbus interface card.</p> <p>[Caution] Check if the fieldbus interface card is loose or not installed.</p> <p>[Solution]</p> <ol style="list-style-type: none"> <li>1. disabled and then enable the function again.</li> <li>2. If this error still occurs, please contact the original purchase of the manufacturer or a third party designated maintenance unit to check the installation of driver of fieldbus interface card.</li> <li>3. If this error still occurs, please contact the original purchase of the manufacturer or a third party designated maintenance unit to check the installation of firmware and configuration files of fieldbus interface card.</li> <li>4. If this error still occurs, backup HMI Log and contact a qualified service engineer for further analysis.</li> </ol>
ErrorSuggestion00044201	<p>[Cause] Driver process error in fieldbus interface card.</p> <p>[Caution] Check if the fieldbus interface card is loose or not installed.</p> <p>[Solution]</p> <ol style="list-style-type: none"> <li>1. disabled and then enable the function again.</li> <li>2. If this error still occurs, please contact the original purchase of the manufacturer or a third party designated maintenance unit to check the installation of driver of fieldbus interface card.</li> <li>3. If this error still occurs, please contact the original purchase of the manufacturer or a third party designated maintenance unit to check the installation of firmware and configuration files of fieldbus interface card.</li> <li>4. If this error still occurs, backup HMI Log and contact a qualified service engineer for further analysis.</li> </ol>
ErrorSuggestion00044202	<p>[Cause] Communication process error in fieldbus interface card.</p> <p>[Caution]</p> <ol style="list-style-type: none"> <li>1. Check the network cable is connected to the correct port on the fieldbus interface card.</li> <li>2. Check if wire cable is loose.</li> <li>3. Check if the wiring setup is correct in the field.</li> <li>4. Check if the setting of the fieldbus interface card (ex. IP, device ID, device name) is correct.</li> <li>5. Check if the software configure and files are correct on connected master device (ex. PLC)</li> </ol> <p>[Solution]</p> <ol style="list-style-type: none"> <li>1. After correcting the possible error, disabled the function and then enable again.</li> <li>2. If this error still occurs, please contact the original purchase of the manufacturer or a third party designated maintenance unit to check the installation of firmware and configuration files of fieldbus interface card.</li> <li>3. If this error still occurs, backup HMI Log and contact a qualified service engineer for further analysis.</li> </ol>
ErrorSuggestion00044203	<ol style="list-style-type: none"> <li>1. Please backup the HMI Log.</li> <li>2. Please contact the original purchase of the manufacturer or a third party designated maintenance unit.</li> </ol>
ErrorSuggestion00044204	<p>[Cause] The device can't be activate as the device or driver is not installed correctly.</p> <p>[Solution] Please install device and driver correctly</p>
ErrorSuggestion00044205	<p>Power cycle robot to change the firmware on the fieldbus interface device. After start up, go back to this page and manually enable the target fieldbus setting again.</p>
ErrorSuggestion00044300	None.
ErrorSuggestion00044301	None.

ErrorSuggestion00044302	<ol style="list-style-type: none"> <li>1. Please backup the HMI Log.</li> <li>2. Please contact the original purchase of the manufacturer or a third party designated maintenance unit.</li> </ol>
ErrorSuggestion00044303	<ol style="list-style-type: none"> <li>1. Please backup the HMI Log.</li> <li>2. Please contact the original purchase of the manufacturer or a third party designated maintenance unit.</li> </ol>
ErrorSuggestion00044304	<p>[Cause] System cannot read data via profinet expression function.</p> <p>[Caution]</p> <ol style="list-style-type: none"> <li>1. Check the fieldbus interface card is set to Profinet.</li> <li>2. Check Profinet function have be enabled.</li> <li>3. Check function name and its argument are valid.</li> </ol> <p>[Solution]</p> <ol style="list-style-type: none"> <li>1. Type in correct function and argument, and execute the project again.</li> <li>2. If this still does not work, contact the original purchase of the manufacturer or a third party designated maintenance unit to check the installation of fieldbus interface card.</li> <li>3. If this still does not work, backup HMI Log and contact a qualified service engineer for further analysis.</li> </ol>
ErrorSuggestion00044305	<p>[Cause] System cannot write data via profinet expression function.</p> <p>[Caution]</p> <ol style="list-style-type: none"> <li>1. Check the fieldbus interface card is set to Profinet.</li> <li>2. Check Profinet function have be enabled.</li> <li>3. Check function name and its argument are valid.</li> </ol> <p>[Solution]</p> <ol style="list-style-type: none"> <li>1. Type in correct function and argument, and execute the project again.</li> <li>2. If this still does not work, contact the original purchase of the manufacturer or a third party designated maintenance unit to check the installation of fieldbus interface card.</li> <li>3. If this still does not work, backup HMI Log and contact a qualified service engineer for further analysis.</li> </ol>
ErrorSuggestion00044400	None.
ErrorSuggestion00044401	None.
ErrorSuggestion00044402	<ol style="list-style-type: none"> <li>1. Please backup the HMI Log.</li> <li>2. Please contact the original purchase of the manufacturer or a third party designated maintenance unit.</li> </ol>
ErrorSuggestion00044403	<ol style="list-style-type: none"> <li>1. Please backup the HMI Log.</li> <li>2. Please contact the original purchase of the manufacturer or a third party designated maintenance unit.</li> </ol>
ErrorSuggestion00044404	<p>[Cause] System cannot read data via EtherCAT expression function.</p> <p>[Caution]</p> <ol style="list-style-type: none"> <li>1. Check the fieldbus interface card is set to EtherCAT.</li> <li>2. Check EtherCAT function have be enabled.</li> <li>3. Check function name and its argument are valid.</li> </ol> <p>[Solution]</p> <ol style="list-style-type: none"> <li>1. Type in correct function and argument, and execute the project again.</li> <li>2. If this still does not work, contact the original purchase of the manufacturer or a third party designated maintenance unit to check the installation of fieldbus interface card.</li> <li>3. If this still does not work, backup HMI Log and contact a qualified service engineer for further analysis.</li> </ol>
ErrorSuggestion00044405	<p>[Cause] System cannot write data via EtherCAT expression function.</p> <p>[Caution]</p> <ol style="list-style-type: none"> <li>1. Check the fieldbus interface card is set to EtherCAT.</li> <li>2. Check EtherCAT function have be enabled.</li> <li>3. Check function name and its argument are valid.</li> </ol> <p>[Solution]</p> <ol style="list-style-type: none"> <li>1. Type in correct function and argument, and execute the project again.</li> </ol>

	<ol style="list-style-type: none"> <li>If this still does not work, contact the original purchase of the manufacturer or a third party designated maintenance unit to check the installation of fieldbus interface card.</li> <li>If this still does not work, backup HMI Log and contact a qualified service engineer for further analysis.</li> </ol>
ErrorSuggestion00044500	None.
ErrorSuggestion00044501	None.
ErrorSuggestion00044502	<ol style="list-style-type: none"> <li>Please backup the HMI Log.</li> <li>Please contact the original purchase of the manufacturer or a third party designated maintenance unit.</li> </ol>
ErrorSuggestion00044503	<ol style="list-style-type: none"> <li>Please backup the HMI Log.</li> <li>Please contact the original purchase of the manufacturer or a third party designated maintenance unit.</li> </ol>
ErrorSuggestion00044504	<p>[Cause] System cannot read data via EtherNet/IP expression function.</p> <p>[Caution]</p> <ol style="list-style-type: none"> <li>Check the fieldbus interface card is set to EtherNet/IP.</li> <li>Check EtherNet/IP function have be enabled.</li> <li>Check function name and its argument are valid.</li> </ol> <p>[Solution]</p> <ol style="list-style-type: none"> <li>Type in correct function and argument, and execute the project again.</li> <li>If this still does not work, contact the original purchase of the manufacturer or a third party designated maintenance unit to check the installation of fieldbus interface card.</li> <li>If this still does not work, backup HMI Log and contact a qualified service engineer for further analysis.</li> </ol>
ErrorSuggestion00044505	<p>[Cause] System cannot write data via EtherNet/IP expression function.</p> <p>[Caution]</p> <ol style="list-style-type: none"> <li>Check the fieldbus interface card is set to EtherNet/IP.</li> <li>Check EtherNet/IP function have be enabled.</li> <li>Check function name and its argument are valid.</li> </ol> <p>[Solution]</p> <ol style="list-style-type: none"> <li>Type in correct function and argument, and execute the project again.</li> <li>If this still does not work, contact the original purchase of the manufacturer or a third party designated maintenance unit to check the installation of fieldbus interface card.</li> <li>If this still does not work, backup HMI Log and contact a qualified service engineer for further analysis.</li> </ol>
ErrorSuggestion00044600	<p>[Cause]</p> <p>Unexpected interruption happened on both drivers.</p> <p>[Solution]</p> <ol style="list-style-type: none"> <li>Please try enable both drivers again and see if this issue still happens.</li> <li>Please try reboot the robot again and see if this issue still happens.</li> <li>Please export the log and contact with Techman Robot Inc.</li> </ol>
ErrorSuggestion00044601	<p>[Cause]</p> <p>Unexpected interruption happened on TMflow ROS drivers.</p> <p>[Solution]</p> <ol style="list-style-type: none"> <li>Please try enable both drivers again and see if this issue still happens.</li> <li>Please try reboot the robot again and see if this issue still happens.</li> <li>Please export the log and contact with Techman Robot Inc.</li> </ol>
ErrorSuggestion00044602	<p>[Cause]</p> <p>Unexpected interruption happened on TMvision ROS drivers.</p> <p>[Solution]</p>

ErrorSuggestion00044603	<ol style="list-style-type: none"> <li>1. Please try enable both drivers again and see if this issue still happens.</li> <li>2. Please try reboot the robot again and see if this issue still happens.</li> <li>3. Please export the log and contact with Techman Robot Inc.</li> </ol>
	<p>[Cause] It takes too long to initialize the TM ROS driver.</p>
	<p>[Solution]</p> <ol style="list-style-type: none"> <li>1. Please try enable both drivers again and see if this issue still happens.</li> <li>2. Please try reboot the robot again and see if this issue still happens.</li> <li>3. Please export the log and contact with Techman Robot Inc.</li> </ol>
ErrorSuggestion00044604	<p>[Cause] There is no ROS driver being install on the robot.</p>
	<p>[Solution]</p> <ol style="list-style-type: none"> <li>1. Please export the log and contact with Techman Robot Inc.</li> <li>2. It might require a image update.</li> </ol>
ErrorSuggestion00045000	<p>[Cause] The system detected a disconnection on the USB drive during the process of Import/Export</p>
	<p>[Caution]</p> <ol style="list-style-type: none"> <li>1. Check if the USB drive is plugged well onto the control box.</li> <li>2. If the USB drive is plugged well, try another USB drive and see if the same issue happens during Export/Import.</li> <li>3. Check if there are other USB devices on the control box, remove them and try again</li> </ol>
	<p>[Additional Explanation] If the USB drive is confirmed to be plugged well, that means this error may be caused by USB or USB port hardware/firmware issue</p>
	<p>[Solution]</p> <ol style="list-style-type: none"> <li>1. Trigger Robot Stick Reset button or user connected Reset input to restore the error status</li> <li>2. Make sure the USB drive is well connected to the control box</li> <li>3. Try Import/Export again</li> <li>4. Avoid removing the USB drive during the process of Import/Export</li> <li>5. After finishing the process of export/ import job, wait for a few seconds before unplugging the USB drive</li> </ol>
ErrorSuggestion00045001	<p>[Cause] External drive do not have enough free space for user export data.</p>
	<p>[Caution] Check if the disk space is insufficient.</p>
	<p>[Additional Explanations] If user wants to export a very large data from robot, the external devices needs a sufficient free space.</p>
	<p>[Solution]</p> <ol style="list-style-type: none"> <li>1. Find another USB which has enough space for data export.</li> <li>2. Check the external devices which has enough space for data export.</li> </ol>
ErrorSuggestion00045002	<p>Files are held. Please try again after restart</p>
ErrorSuggestion00045003	<p>[Cause] The compressed file in the USB drive had been damaged and the system failed to import it</p>
	<p>[Caution]</p> <ol style="list-style-type: none"> <li>1. Check if the compressed file in the USB drive is damaged by trying to unzip; if it is damaged, there would be a related message.</li> <li>2. Check if that file fails to be imported to this robot only.</li> <li>3. Check if other files in the USB drive also have the same issue.</li> </ol>
	<p>[Additional Explanation] Removing the USB drive too quickly just after exporting a file (even with the message of "Export successfully") might damage it</p>
	<p>[Solution]</p>

ErrorSuggestion00045004	<p>1. Trigger Robot Stick Reset button or user connected Reset input to restore the error status</p> <p>2. After exporting the file, keep the USB drive still for a few seconds before unplugging it from the control box</p> <p>[Cause] Robot detect the file cannot be accessed or executed.</p> <p>[Additional Explanation] When the robot cannot access the data from project 、 system update、 backup/recovery、 Path node file ...etc, it would cause this error.</p> <p>[Solution]</p> <p>1. Click on the OK button on the pop windows.</p> <p>2. Trigger Robot Stick Reset button or user connected Reset input to restore the error status</p> <p>3. Contact your service engineer and export the Logs for further analysis.</p>
ErrorSuggestion00045005	<p>[Cause] Robot detect the file cannot be accessed or executed.</p> <p>[Precaution] This error would only show on the pop up window, not in the HMI log.</p> <p>[Solution]</p> <p>1. Click on the OK and close the pop window.</p> <p>2. Contact your service engineer and export the Logs for further analysis.</p>
ErrorSuggestion00045006	<p>[Cause] TM client fails to connect to the robot(server)</p> <p>[Caution] Check if the network connection/cable between robot and client is stable.</p> <p>[Additional Explanation] Abnormal socket disconnection would cause program error exception while the program is running between robot and client.</p> <p>[Solution]</p> <p>1. Trigger Robot Stick Reset button or user connected Reset input to restore the error status</p> <p>2. Make sure the network connection/cable is stable during the connection process.</p>
ErrorSuggestion00045007	<p>[Cause] The connection between robot and the TM clients is failed.</p> <p>[Caution] Check if the network connection/cable between robot and client is stable.</p> <p>[Additional Explanation] Abnormal socket disconnection would cause program error exception while the program is running between robot and client.</p> <p>[Solution]</p> <p>1. Trigger Robot Stick Reset button or user connected Reset input to restore the error status</p> <p>2. Make sure the network connection/cable is stable during the connection process.</p>
ErrorSuggestion00045008	<p>[Cause] The communication between robot and the TM client is failed.</p> <p>[Caution] Check if the network connection/cable between robot and client is stable.</p> <p>[Additional Explanation] Abnormal socket disconnection would cause program error exception while the program is running between robot and client.</p> <p>[Solution]</p> <p>1. Trigger Robot Stick Reset button or user connected Reset input to restore the error status</p> <p>2. Make sure the network connection/cable is stable during the connection process.</p>
ErrorSuggestion00045009	<p>1. Please backup the HMI Log.</p> <p>2. Please contact the original purchase of the manufacturer or a third party designated maintenance unit.</p>
ErrorSuggestion0004500A	<p>[Cause] HMI client and HMI server is disconnection.</p> <p>[Caution] Check if there is any follow up error logs or messages with this error code.</p> <p>[Solution]</p>
ErrorSuggestion0004500B	<p>1. Trigger Robot Stick Reset button or user connected Reset input to restore the error status</p> <p>2. Contact your service engineer and export the Logs for further analysis.</p> <p>[Cause] Robot detect the network path settings is wrong or cannot be accessed.</p> <p>[Caution]</p> <p>1. Check if the network path in the export/import is correct.</p> <p>2. Check if the network cable is loose.</p> <p>[Additional Explanation] Abnormal network disconnection would cause data transfer failed.</p>



	[Solution] 1. Click on the OK button and close the pop window. 2. Trigger Robot Stick Reset button or user connected Reset input to restore the error status 3. Make sure the network setting/cable are correct and stable before/during the data transfer process.
ErrorSuggestion0004500C	[Cause] The space of system drive is not enough. [Caution] Check if have the enough space of the system drive (for TMFlow.exe on PC) [Additional Explanation] This error usually appears in HMI during Import/Export files if there is not enough space in the system
	[Solution] 1. Click on the OK button on the pop up windows. 2. Trigger Robot Stick Reset button or user connected Reset input to restore the error status 3. Clear some data and reserve enough free space for use. 4. Make sure there is enough space for storage on the system
ErrorSuggestion0004500D	Please check whether the UNC path is correct include username and password
ErrorSuggestion0004500E	Please check whether the UNC path is correct
ErrorSuggestion0004500F	Please check whether Network adapter is active
ErrorSuggestion00045010	Please check whether Network environment and IP address
ErrorSuggestion00045011	Please check whether Network adapters are enabled
ErrorSuggestion00045020	[Cause] The free space of the hard disk is short. [Solution] Please contact a qualified service engineer for further analysis with log files
ErrorSuggestion00045021	[Cause] The free space of the hard disk is short. [Solution] Please contact a qualified service engineer for further analysis with log files
ErrorSuggestion00045100	[Cause] HMI update failed [Caution] Shutdown and power on the system again to see if this error still appears [Additional Explanation] If the update is interrupted during process, such as, closing the execution windows, restart or power off the system manually, power cut-off, etc.; this might cause the control box and robot's firmware update incomplete and failed. [Solution] 1. Contact a qualified service engineer for further analysis Avoid any interruption during HMI update: 1. Do not cut off the power during process 2. Do not close the execution windows during process 3. Do not close or restart the system manually during process
ErrorSuggestion00045101	Please contact the original purchase of the manufacturer or a third party designated maintenance unit.
ErrorSuggestion00045200	1. Please backup the HMI Log. 2. Please contact the original purchase of the manufacturer or a third party designated maintenance unit.
ErrorSuggestion00045201	Please stop the current executing project.
ErrorSuggestion00045202	Please confirm the file name for import and export.
ErrorSuggestion00045203	Please confirm the file path for import and export.
ErrorSuggestion00045204	Please check if the file existed.
ErrorSuggestion00045205	Please check if the file path existed.
ErrorSuggestion00045206	File name duplicated.
ErrorSuggestion00045207	Please confirm the space for import and export.
ErrorSuggestion00045208	Please confirm if the system temporary space is enough.
ErrorSuggestion00045209	Please confirm if the system space is enough.
ErrorSuggestion0004520A	Please confirm if the external device space is enough.



ErrorSuggestion0004520B	<ol style="list-style-type: none"> <li>1. Please retry again.</li> <li>2. Please backup the HMI Log.</li> <li>3. Please contact the original purchase of the manufacturer or a third party designated maintenance unit.</li> </ol>
ErrorSuggestion0004520C	<ol style="list-style-type: none"> <li>1. Please retry again.</li> <li>2. Please backup the HMI Log.</li> <li>3. Please contact the original purchase of the manufacturer or a third party designated maintenance unit.</li> </ol>
ErrorSuggestion0004520D	<ol style="list-style-type: none"> <li>1. Please retry again.</li> <li>2. Please backup the HMI Log.</li> <li>3. Please contact the original purchase of the manufacturer or a third party designated maintenance unit.</li> </ol>
ErrorSuggestion0004520E	<ol style="list-style-type: none"> <li>1. Please retry again.</li> <li>2. Please backup the HMI Log.</li> <li>3. Please contact the original purchase of the manufacturer or a third party designated maintenance unit.</li> </ol>
ErrorSuggestion0004520F	<ol style="list-style-type: none"> <li>1. Please retry again.</li> <li>2. Please backup the HMI Log.</li> <li>3. Please contact the original purchase of the manufacturer or a third party designated maintenance unit.</li> </ol>
ErrorSuggestion00045210	<ol style="list-style-type: none"> <li>1. Please retry again.</li> <li>2. Please backup the HMI Log.</li> <li>3. Please contact the original purchase of the manufacturer or a third party designated maintenance unit.</li> </ol>
ErrorSuggestion00045211	<ol style="list-style-type: none"> <li>1. Please retry again.</li> <li>2. Please backup the HMI Log.</li> <li>3. Please contact the original purchase of the manufacturer or a third party designated maintenance unit.</li> </ol>
ErrorSuggestion00045212	<ol style="list-style-type: none"> <li>1. Please backup the HMI Log.</li> <li>2. Please contact the original purchase of the manufacturer or a third party designated maintenance unit.</li> </ol>
ErrorSuggestion00045213	<ol style="list-style-type: none"> <li>1. Please backup the HMI Log.</li> <li>2. Please contact the original purchase of the manufacturer or a third party designated maintenance unit.</li> </ol>
ErrorSuggestion00045214	<ol style="list-style-type: none"> <li>1. Please confirm the robot model type and the actual robot model type.</li> <li>2. Please use the matched safety configuration file.</li> <li>3. Please backup the HMI Log.</li> <li>4. Please contact the original purchase of the manufacturer or a third party designated maintenance unit.</li> </ol>
ErrorSuggestion00045215	<ol style="list-style-type: none"> <li>1. Please confirm the safety system version and the actual safety system version</li> <li>2. Please use the matched safety configuration file.</li> <li>3. Please backup the HMI Log.</li> <li>4. Please contact the original purchase of the manufacturer or a third party designated maintenance unit.</li> </ol>
ErrorSuggestion00045216	<ol style="list-style-type: none"> <li>1. Please retry again.</li> <li>2. Please backup the HMI Log.</li> <li>3. Please contact the original purchase of the manufacturer or a third party designated maintenance unit.</li> </ol>
ErrorSuggestion00045217	<ol style="list-style-type: none"> <li>1. Please retry again.</li> <li>2. Please backup the HMI Log.</li> <li>3. Please contact the original purchase of the manufacturer or a third party designated maintenance unit.</li> </ol>
ErrorSuggestion00045218	<ol style="list-style-type: none"> <li>1. Please check and confirm the file is correct .</li> <li>2. Please retry again.</li> <li>3. Please backup the HMI Log.</li> <li>4. Please contact the original purchase of the manufacturer or a third party designated maintenance unit.</li> </ol>
ErrorSuggestion00045219	<ol style="list-style-type: none"> <li>1. Please check and confirm the file is correct .</li> <li>2. Please retry again.</li> <li>3. Please backup the HMI Log.</li> <li>4. Please contact the original purchase of the manufacturer or a third party designated maintenance unit.</li> </ol>

ErrorSuggestion00045240	1. Please backup the HMI Log and Projects. 2. Please contact the original purchase of the manufacturer or a third party designated maintenance unit.
ErrorSuggestion00045241	1. Please backup the HMI Log and Projects. 2. Please contact the original purchase of the manufacturer or a third party designated maintenance unit.
ErrorSuggestion00045242	1. Please backup the HMI Log and Projects. 2. Please contact the original purchase of the manufacturer or a third party designated maintenance unit.
ErrorSuggestion00045243	1. Please backup the HMI Log and Projects. 2. Please contact the original purchase of the manufacturer or a third party designated maintenance unit.
ErrorSuggestion00045244	1. Please backup the HMI Log and Projects. 2. Please contact the original purchase of the manufacturer or a third party designated maintenance unit.
ErrorSuggestion00045245	1. Please backup the HMI Log and Projects. 2. Please contact the original purchase of the manufacturer or a third party designated maintenance unit.
ErrorSuggestion00045246	1. Please backup the HMI Log and Projects. 2. Please contact the original purchase of the manufacturer or a third party designated maintenance unit.
ErrorSuggestion00045247	1. Please backup the HMI Log and Projects. 2. Please contact the original purchase of the manufacturer or a third party designated maintenance unit.
ErrorSuggestion00045248	1. Please backup the HMI Log and Projects. 2. Please contact the original purchase of the manufacturer or a third party designated maintenance unit.
ErrorSuggestion00048000	1. Please backup the HMI Log and Projects. 2. Please contact the original purchase of the manufacturer or a third party designated maintenance unit.
ErrorSuggestion00048001	1. Please backup the HMI Log and Projects. 2. Please contact the original purchase of the manufacturer or a third party designated maintenance unit.
ErrorSuggestion00048002	1. Please backup the HMI Log and Projects. 2. Please contact the original purchase of the manufacturer or a third party designated maintenance unit.
ErrorSuggestion00048003	1. Please backup the HMI Log and Projects. 2. Please contact the original purchase of the manufacturer or a third party designated maintenance unit.
ErrorSuggestion00048004	1. Please backup the HMI Log and Projects. 2. Please contact the original purchase of the manufacturer or a third party designated maintenance unit.
ErrorSuggestion00048005	1. Please backup the HMI Log and Projects. 2. Please contact the original purchase of the manufacturer or a third party designated maintenance unit.
ErrorSuggestion00048006	1. Please backup the HMI Log and Projects. 2. Please contact the original purchase of the manufacturer or a third party designated maintenance unit.
ErrorSuggestion00048080	1. Please backup the HMI Log and Projects. 2. Please contact the original purchase of the manufacturer or a third party designated maintenance unit.
ErrorSuggestion00048081	1. Please backup the HMI Log and Projects. 2. Please contact the original purchase of the manufacturer or a third party designated maintenance unit.
ErrorSuggestion00048082	[Cause] Value assigned is in invalid number format [Caution] Check if the value assigned to a variable is valid format type. [Additional Explanation] For number format, Incorrect: 0x12CG // Hex includes values(0-9, a-F). 「G」 is invalid. 0b1212 // Binary includes values(0, 1). 「2」 is invalid. Correct: 0x12CF // Hex value is valid. 0b1110 // Binary value is valid. [Additional Explanation] This error usually appears in

	1. The project file is generated by 3rd party flow editor
	2. The input format error in Listen Node
	3. In flow editing, it usually appears with a pop-up windows with warning message 「Invalid Value」
	[Solution]
	1. Trigger Robot Stick Reset button or user connected Reset input to restore the error status
	2. Input the valid number format
	if it appears the pop-up windows with warning message 「Invalid Value」, click OK to close it
	Make sure the variables used are with a valid number format.
ErrorSuggestion00048083	Please check string format is well-formed
ErrorSuggestion00048084	1. Please backup the HMI Log and Projects.
	2. Please contact the original purchase of the manufacturer or a third party designated maintenance unit.
ErrorSuggestion00048100	1. Please backup the HMI Log and Projects.
	2. Please contact the original purchase of the manufacturer or a third party designated maintenance unit.
ErrorSuggestion00048101	Please check { } format is well-formed
ErrorSuggestion00048102	Please check { } format is well-formed
ErrorSuggestion00048103	Please check [ ] format is well-formed
ErrorSuggestion00048104	Please check [ ] format is well-formed
ErrorSuggestion00048105	Please check ( ) format is well-formed
ErrorSuggestion00048106	Please check ( ) format is well-formed
ErrorSuggestion00048107	Please check if expression is well-formed
ErrorSuggestion00048108	Please check if expression is well-formed
ErrorSuggestion00048109	Please check if expression is well-formed
ErrorSuggestion0004810A	Please check switch expression is well-formed
ErrorSuggestion0004810B	Please check switch expression is well-formed
ErrorSuggestion0004810C	Please check switch expression is well-formed
ErrorSuggestion0004810D	Please remove duplicated switch case condition
ErrorSuggestion0004810E	Please check for-loop expression is well-formed
ErrorSuggestion0004810F	Please check for-loop expression is well-formed
ErrorSuggestion00048110	Please check do-while expression is well-formed
ErrorSuggestion00048111	Please check do-while expression is well-formed
ErrorSuggestion00048112	Please check do-while expression is well-formed
ErrorSuggestion00048113	1. Please backup the HMI Log and Projects.
	2. Please contact the original purchase of the manufacturer or a third party designated maintenance unit.
ErrorSuggestion00048114	1. Please backup the HMI Log and Projects.
	2. Please contact the original purchase of the manufacturer or a third party designated maintenance unit.
ErrorSuggestion00048115	1. Please backup the HMI Log and Projects.
	2. Please contact the original purchase of the manufacturer or a third party designated maintenance unit.
ErrorSuggestion00048116	Please modify void data type to supported data type
ErrorSuggestion00048117	Please check variables declaration is well-formed
ErrorSuggestion00048118	Please check variables declaration is well-formed
ErrorSuggestion00048119	Please check function data type of parameters
ErrorSuggestion0004811A	Please check array declaration is well-formed
ErrorSuggestion0004811B	Please modify array data type to supported data type
ErrorSuggestion0004811C	1. Please backup the HMI Log and Projects.
	2. Please contact the original purchase of the manufacturer or a third party designated maintenance unit.
ErrorSuggestion0004811D	1. Please backup the HMI Log and Projects.
	2. Please contact the original purchase of the manufacturer or a third party designated maintenance unit.

ErrorSuggestion0004811E	<ol style="list-style-type: none"> <li>1. Please backup the HMI Log and Projects.</li> <li>2. Please contact the original purchase of the manufacturer or a third party designated maintenance unit.</li> </ol>
ErrorSuggestion0004811F	Please check expression token is well-formed
ErrorSuggestion00048180	<ol style="list-style-type: none"> <li>1. Please backup the HMI Log and Projects.</li> <li>2. Please contact the original purchase of the manufacturer or a third party designated maintenance unit.</li> </ol>
ErrorSuggestion00048181	Please remove duplicated function node definition
ErrorSuggestion00048182	Please remove duplicated function definition
ErrorSuggestion00048183	<p>[Cause] There are variables created with the repeated name in project.</p> <p>[Caution] Check if there are variables with the same name.</p> <p>[Additional Explanation]</p> <p>This error usually appears if</p> <ol style="list-style-type: none"> <li>1. The project file is generated by 3rd party flow editor</li> <li>2. The input format to Listen Node is incorrect</li> <li>3. In flow editing, it usually appears with a pop-up windows with warning message 「Variable Name Repeat」</li> </ol> <p>[Solution]</p> <ol style="list-style-type: none"> <li>1. Trigger Robot Stick Reset button or user connected Reset input to restore the error status</li> <li>2. if this error appears as a pop-up windows with the error message 「Variable Name Repeat」, click OK to close it</li> <li>3. Remove the variable with repeated name</li> </ol> <p>Make sure there is no repeated variables in the project.</p>
ErrorSuggestion00048184	<ol style="list-style-type: none"> <li>1. Please backup the HMI Log and Projects.</li> <li>2. Please contact the original purchase of the manufacturer or a third party designated maintenance unit.</li> </ol>
ErrorSuggestion00048185	<ol style="list-style-type: none"> <li>1. Please backup the HMI Log and Projects.</li> <li>2. Please contact the original purchase of the manufacturer or a third party designated maintenance unit.</li> </ol>
ErrorSuggestion00048186	<ol style="list-style-type: none"> <li>1. Please backup the HMI Log and Projects.</li> <li>2. Please contact the original purchase of the manufacturer or a third party designated maintenance unit.</li> </ol>
ErrorSuggestion00048187	<ol style="list-style-type: none"> <li>1. Please backup the HMI Log and Projects.</li> <li>2. Please contact the original purchase of the manufacturer or a third party designated maintenance unit.</li> </ol>
ErrorSuggestion00048188	<ol style="list-style-type: none"> <li>1. Please backup the HMI Log and Projects.</li> <li>2. Please contact the original purchase of the manufacturer or a third party designated maintenance unit.</li> </ol>
ErrorSuggestion00048189	Please assign namespace
ErrorSuggestion0004818A	Please check namespace is well-formed
ErrorSuggestion0004818B	Please check function node is definition
ErrorSuggestion0004818C	Please check function is definition
ErrorSuggestion0004818D	<p>[Cause] System detected a error on Project Flow during running, which is mostly because some variables are missing.</p> <p>[Caution]</p> <ol style="list-style-type: none"> <li>1. Check the message with this error code; it should specify which node has error</li> <li>2. Check if there is another error code also occurs</li> </ol> <p>[Additional Explanation] Remind of the following cases:</p> <ol style="list-style-type: none"> <li>1. Variables created by Pallet node have been deleted accidentally.</li> <li>2. Variables used in any expression (If, Waitfor, Gateway, etc.) have been deleted manually.</li> <li>3. Global variables used in the current robot will not be exported with the project; user need to create the same Global variable or export them separately</li> <li>4. etc.</li> </ol> <p>[Solution]</p> <ol style="list-style-type: none"> <li>1. Trigger Robot Stick Reset button or user connected Reset input to restore the error status</li> </ol> <p>Follow the message of the error code and correct the error</p>

	<ol style="list-style-type: none"> <li>1. Be careful when deleting variables in Variable Manager.</li> <li>2. Study and have a full understanding on Node Function, make sure the settings are correct</li> </ol>
ErrorSuggestion0004818E	<ol style="list-style-type: none"> <li>1. Please backup the HMI Log and Projects.</li> <li>2. Please contact the original purchase of the manufacturer or a third party designated maintenance unit.</li> </ol>
ErrorSuggestion0004818F	<ol style="list-style-type: none"> <li>1. Please backup the HMI Log and Projects.</li> <li>2. Please contact the original purchase of the manufacturer or a third party designated maintenance unit.</li> </ol>
ErrorSuggestion00048190	<ol style="list-style-type: none"> <li>1. Please backup the HMI Log and Projects.</li> <li>2. Please contact the original purchase of the manufacturer or a third party designated maintenance unit.</li> </ol>
ErrorSuggestion00048191	<ol style="list-style-type: none"> <li>1. Please backup the HMI Log and Projects.</li> <li>2. Please contact the original purchase of the manufacturer or a third party designated maintenance unit.</li> </ol>
ErrorSuggestion00048192	<ol style="list-style-type: none"> <li>1. Please backup the HMI Log and Projects.</li> <li>2. Please contact the original purchase of the manufacturer or a third party designated maintenance unit.</li> </ol>
ErrorSuggestion00048193	Please check if return data type and function definition type matched.
ErrorSuggestion00048194	Please check return value within function.
ErrorSuggestion00048195	Please check expression is well-formed
ErrorSuggestion00048200	<ol style="list-style-type: none"> <li>1. Please backup the HMI Log and Projects.</li> <li>2. Please contact the original purchase of the manufacturer or a third party designated maintenance unit.</li> </ol>
ErrorSuggestion00048201	<p>[Cause] System detected a error on Project Flow during running, which is mostly because some variables are missing.</p> <p>[Caution]</p> <ol style="list-style-type: none"> <li>1. Check the message with this error code; it should specify which node has error</li> <li>2. Check if there is another error code also occurs</li> </ol> <p>[Additional Explanation] Remind of the following cases:</p> <ol style="list-style-type: none"> <li>1. Variables created by Pallet node have been deleted accidentally.</li> <li>2. Variables used in any expression (If, Waitfor, Gateway, etc.) have been deleted manually.</li> <li>3. Global variables used in the current robot will not be exported with the project; user need to create the same Global variable or export them separately</li> <li>4. etc.</li> </ol> <p>[Solution]</p> <ol style="list-style-type: none"> <li>1. Trigger Robot Stick Reset button or user connected Reset input to restore the error status</li> </ol> <p>Follow the message of the error code and correct the error</p> <ol style="list-style-type: none"> <li>1. Be careful when deleting variables in Variable Manager.</li> <li>2. Study and have a full understanding on Node Function, make sure the settings are correct</li> </ol>
ErrorSuggestion00048202	Please check function is definition
ErrorSuggestion00048203	<ol style="list-style-type: none"> <li>1. Please backup the HMI Log and Projects.</li> <li>2. Please contact the original purchase of the manufacturer or a third party designated maintenance unit.</li> </ol>
ErrorSuggestion00048204	<ol style="list-style-type: none"> <li>1. Please backup the HMI Log and Projects.</li> <li>2. Please contact the original purchase of the manufacturer or a third party designated maintenance unit.</li> </ol>
ErrorSuggestion00048205	Please check key index value of parameterized data
ErrorSuggestion00048206	Please check parameterized data group classes
ErrorSuggestion00048207	Please check expression is well-formed
ErrorSuggestion00048208	<p>[Cause] Invalid expression</p> <p>[Caution] In SET node,</p> <p>It is invalid in the expression with the form:</p> <pre>int\var_i= GetNow()+=10</pre> <p>(Functions with the following operands :</p> <p>「+=」、「 -=」、「 *=」、「 /=」)</p> <p>[Additional Explanation]</p>

ErrorSuggestion00048209

This error usually appears in

1. The project file is generated by 3rd party flow editor
2. In flow editing, it usually appears with a pop-up windows with warning message 「Function operation is not allowed」

[Solution]

1. Trigger Robot Stick Reset button or user connected Reset input to restore the error status
2. If this error appears as pop-up windows with the error message 「Function operation is not allowed」, click OK to close it
3. Remove the invalid operant (「+=」, 「-=」, 「\*=」, 「/=」) triggering the error

Make sure all expressions all correct

[Cause] The expression is assigned with a invalid operator in array operations.

[Caution] Check if there is any missing index of the array.

Or a incorrect operator has been chosen

[Precaution] This error would only show on the pop up windows, not in the HMI log.

[Additional Explanations]

The error code is often triggered between two arrays' operation without index assigning:

In assignment expression of project node (SET).

Incorrect operators: (" += ", " -= ", " \*= ", " /= ")

(i.e. var\_array\_A += var\_array\_B)

Correct operators: (" = ")

(i.e. var\_array\_A = var\_array\_B)

In comparison expression of project node (IF).

Incorrect operators: (" > ", " >= ", " < ", " <= ")

(i.e. var\_array\_A >= var\_array\_B)

Correct operators: ("==" or "!=")

(i.e. var\_array\_A == var\_array\_B)

[Solution]

1. Click on the OK button on the pop up windows then assign the suitable operators.
2. Makes sure all assignment and comparison expressions have the valid operator.

ErrorSuggestion0004820A

Please check data type is match class constructor definition

ErrorSuggestion0004820B

1. Please backup the HMI Log and Projects.
2. Please contact the original purchase of the manufacturer or a third party designated maintenance unit.

ErrorSuggestion0004820C

Please modify array data type to supported data type

ErrorSuggestion0004820D

[Cause] The expression is assigned with a invalid operator in array operations.

[Caution] Check if there is any missing index of the array.

Or a incorrect operator has been chosen

[Precaution] This error would only show on the pop up windows, not in the HMI log.

[Additional Explanations]

The error code is often triggered between two arrays' operation without index assigning:

In assignment expression of project node (SET).

Incorrect operators: (" += ", " -= ", " \*= ", " /= ")

(i.e. var\_array\_A += var\_array\_B)

Correct operators: (" = ")

(i.e. var\_array\_A = var\_array\_B)

In comparison expression of project node (IF).

Incorrect operators: (" > ", " >= ", " < ", " <= ")

(i.e. var\_array\_A >= var\_array\_B)

Correct operators: ("==" or "!=")

ErrorSuggestion0004820E	<p>(i.e. var_array_A == var_array_B)</p> <p>[Solution]</p> <ol style="list-style-type: none"> <li>1. Click on the OK button on the pop up windows then assign the suitable operators.</li> <li>2. Makes sure all assignment and comparison expressions have the valid operator.</li> </ol> <p>[Cause] The index used on a array variable is not a integer</p> <p>[Caution] Check if any variables used as a array index in the project is assigned to be a null value or a non-integral value</p> <p>[Additional explanation] The variable used as a array index is invalid in value possibly by initialization or assigned by SET node during project run</p> <p>[Additional Explanation] If the variable used as a array index is deleted, the value will become null</p> <p>[Solution]</p> <ol style="list-style-type: none"> <li>1. Trigger Robot Stick Reset button or user connected Reset input to restore the error status</li> <li>2. Then you can find the robot LED shows green color</li> </ol>
ErrorSuggestion0004820F	<p>Make sure before you delete any variable in the project, check if it is as a array index or not</p> <p>[Cause] The HMI detected a invalid index used on a array variable during project run</p> <p>[Caution] Check if the value any variables used as a array index is out of range or a negative quantity</p> <p>[Additional explanation] The variable used as a array index is invalid in value possibly by initialization or assigned by SET node during project run</p> <p>[Solution]</p> <ol style="list-style-type: none"> <li>1. Trigger Robot Stick Reset button or user connected Reset input to restore the error status</li> <li>2. Make the initial value of all index variables is correct</li> <li>3. Make sure the value of all index variables would not be change incorrectly by any SET node</li> </ol>
ErrorSuggestion00048210	<p>[Cause] The expression is assigned with a invalid operand.</p> <p>[Caution] Check if the operands of the related expression (which operators are: "==", "&gt;=", "&lt;==", etc.) are assigned the number type value or variable in the current project node (SET, IF, etc.)</p> <p>[Precaution] This error would only show on the pop up windows, not in the HMI log.</p> <p>[Solution]</p> <ol style="list-style-type: none"> <li>1. Click on the OK button on the pop up windows then assign the number type value or variable to the operands.</li> <li>2. Makes sure all expressions have the valid operand.</li> </ol>
ErrorSuggestion00048211	<p>[Cause] The expression is assigned with a invalid operand.</p> <p>[Caution] Check if the value or variable is integer type after the complement operator (" ~ ") in the current project node (SET, IF, etc.)</p> <p>[Precaution] This error would only show on the pop up windows, not in the HMI log.</p> <p>[Solution]</p> <ol style="list-style-type: none"> <li>1. Click on the OK button on the pop up windows then assign the integer type value or variable to the operand after the complement operator.</li> <li>2. Makes sure all expressions with the complement operator have the valid operand.</li> </ol>
ErrorSuggestion00048212	<p>[Cause] System detected a error on Project Flow during running, which is mostly because some variables are missing.</p> <p>[Caution]</p> <ol style="list-style-type: none"> <li>1. Check the message with this error code; it should specify which node has error</li> <li>2. Check if there is another error code also occurs</li> </ol> <p>[Additional Explanation] Remind of the following cases:</p> <ol style="list-style-type: none"> <li>1. Variables created by Pallet node have been deleted accidentally.</li> <li>2. Variables used in any expression (If, Waitfor, Gateway, etc.) have been deleted manually.</li> <li>3. Global variables used in the current robot will not be exported with the project; user need to create the same Global variable or export them separately</li> <li>4. etc.</li> </ol>



ErrorSuggestion00048213	<p>[Solution]</p> <ol style="list-style-type: none"> <li>1. Trigger Robot Stick Reset button or user connected Reset input to restore the error status</li> </ol> <p>Follow the message of the error code and correct the error</p> <ol style="list-style-type: none"> <li>1. Be careful when deleting variables in Variable Manager.</li> <li>2. Study and have a full understanding on Node Function, make sure the settings are correct</li> </ol> <p>[Cause] In the expression, the data type of variable assignment error.</p> <p>[Caution] Check if the operand 「++」 or 「--」 are used properly with integer data type</p> <p>[Additional Explanation]</p> <p>This error usually happens in a SET Node.</p> <p>The operands 「++」、 「--」 are only used by integer variable. (i.e. var a: a++, a--, ++a, --a)</p>
ErrorSuggestion00048214	<p>[Solution]</p> <ol style="list-style-type: none"> <li>1. Click OK and close the popped up windows</li> <li>2. Correct the data type of variable as integer type in expression</li> </ol> <p>Make sure the operand 「++」 or 「--」 are used properly with integer data type</p> <p>[Cause] The item following the symbol "!" is invalid in a expression which is supposed to be a Boolean type object (or variable)</p> <p>[Caution] Check if the subject after the symbol "!" is a Boolean type object or not</p> <p>[Precaution] This error would only show on the pop up windows, not in the HMI log.</p>
ErrorSuggestion00048215	<p>[Solution]</p> <ol style="list-style-type: none"> <li>1. Click on the OK button on the pop up windows.</li> <li>2. Correct the expression</li> </ol> <p>Check and confirm the type is correct while creating a expression.</p> <p>[Cause] The expression is assigned with a invalid operand.</p> <p>[Caution] Check if the operand in the left side of the assignment operator (" = ") is type matching with the right side one in the current project node (SET)</p> <p>[Precaution] This error would only show on the pop up windows, not in the HMI log.</p>
ErrorSuggestion00048216	<p>[Solution]</p> <ol style="list-style-type: none"> <li>1. Click on the OK button on the pop up windows then assign the same type value or variable to the operand in the expression.</li> <li>2. Makes sure all assignment of expressions have the valid type-matching operand.</li> </ol> <p>[Cause] There is a invalid usage on a expression</p> <p>[Caution] Check if the data type is matched from both sides of a expression, especially on a IF node</p> <p>[Precaution] This error would only show on the pop up windows, not in the HMI log.</p> <p>[Additional Explanation] This error would be triggered if there is a invalid symbol usage and only have it on a expression, for example: string == ###</p>
ErrorSuggestion00048217	<p>[Solution]</p> <ol style="list-style-type: none"> <li>1. Click on the OK button on the pop up windows.</li> <li>2. Correct the expression</li> </ol> <p>Check and confirm the type is correct while creating a expression.</p> <p>[Cause] There is a invalid usage on a expression</p> <p>[Caution] Check if the data type is matched from both sides of a expression, especially on a IF node</p> <p>[Precaution] This error would only show on the pop up windows, not in the HMI log.</p> <p>[Additional Explanation] This error would be triggered if there is a invalid symbol usage and only have it on a expression, for example: string == ###</p>



ErrorSuggestion00048218	<p>[Solution]</p> <ol style="list-style-type: none"> <li>1. Click on the OK button on the pop up windows.</li> <li>2. Correct the expression</li> </ol> <p>Check and confirm the type is correct while creating a expression.</p> <p>[Cause] The HMI detected a division calculation error during the project running</p> <p>[Caution] Check if any variables as a divisor in the project is assigned a value zero by initial setting or during process</p> <p>[Additional Explanation] It often occurs in the division expression of SET and Display Node, or in the Boolean expression of IF and Gateway Node in the project flow</p>
ErrorSuggestion00048219	<p>[Solution]</p> <ol style="list-style-type: none"> <li>1. Trigger Robot Stick Reset button or user connected Reset input to restore the error status</li> <li>2. Designing a program mechanism examines that every variable as a divisor and prevent it running if it is assigned zero</li> </ol> <p>[Cause] Project Flow contains expression modulo by zero</p> <p>[Caution] Check if any variable used as the divisor of a modulo expression could possibly change to zero during project run</p> <p>[Additional Explanation] Usually, HMI will block the expression (warning message) if it is directly as, e.g., "var_result = var_num1%0"; however, if the expression is written as, e.g., "var_result = var_num1%var_num2", if var_num changes to 0 during project run will trigger this error.</p>
ErrorSuggestion0004821A	<p>[Solution]</p> <ol style="list-style-type: none"> <li>1. Trigger Robot Stick Reset button or user connected Reset input to restore the error status</li> <li>2. Correct the issued expression(s)</li> </ol> <p>Make sure the variables used as the divisor will never be zero</p> <p>[Cause] The operand in the expression is assigned a number out of range .</p> <p>[Caution] Check if a integer type operand is assigned a number within valid range in the current project node (SET).</p> <p>[Precaution] This error would possibly show on the pop up windows.</p>
ErrorSuggestion0004821B	<p>[Solution]</p> <ol style="list-style-type: none"> <li>1. Click on the OK button on the pop up windows then assign a valid number to the operand.</li> <li>2. Makes sure all assignment of expressions have the valid operand with the appropriate value.</li> </ol> <p>[Cause] The operand in the expression is assigned a number out of range .</p> <p>[Caution] Check if a integer type operand is assigned a number within valid range in the current project node (SET).</p> <p>[Precaution] This error would possibly show on the pop up windows.</p>
ErrorSuggestion0004821C	<p>[Solution]</p> <ol style="list-style-type: none"> <li>1. Click on the OK button on the pop up windows then assign a valid number to the operand.</li> <li>2. Makes sure all assignment of expressions have the valid operand with the appropriate value.</li> </ol> <p>[Cause] The operand in the expression is assigned a number out of range .</p> <p>[Caution] Check if a integer type operand is assigned a number within valid range in the current project node (SET).</p> <p>[Precaution] This error would possibly show on the pop up windows.</p>
ErrorSuggestion0004821D	<p>[Solution]</p> <ol style="list-style-type: none"> <li>1. Click on the OK button on the pop up windows then assign a valid number to the operand.</li> <li>2. Makes sure all assignment of expressions have the valid operand with the appropriate value.</li> </ol> <p>[Cause] The operand in the expression is assigned a number out of range .</p> <p>[Caution] Check if a integer type operand is assigned a number within valid range in the current project node (SET).</p> <p>[Precaution] This error would possibly show on the pop up windows.</p>
	<p>[Solution]</p> <ol style="list-style-type: none"> <li>1. Click on the OK button on the pop up windows then assign a valid number to the operand.</li> <li>2. Makes sure all assignment of expressions have the valid operand with the appropriate value.</li> </ol>

ErrorSuggestion0004821E	<p>[Cause] The operand in the assignment expression is assigned with a different type number.</p> <p>[Caution] Check if the operand on the left side of the assignment operator (" = ") is type matching with the right side one in the current project node (SET)</p> <p>[Precaution] a error message 『Warning for Number Value may be missing』 would show on the pop up windows when project is edited.</p> <p>If ignore it, this error code would show with the warning message in the HMI log during project running.</p> <p>[Additional Explanation]</p> <p>Number related expression should have the following instruction when using different types, i.e. :</p> <p>Correct :</p> <ol style="list-style-type: none"> <li>1. double = int</li> <li>2. float = int</li> <li>3. double = float</li> </ol> <p>Incorrect :</p> <ol style="list-style-type: none"> <li>1. int = double</li> <li>2. int = float</li> <li>3. float = double</li> </ol> <p>[Solution]</p> <ol style="list-style-type: none"> <li>1. Trigger Robot Stick Reset button or user connected Reset input to restore the error status</li> <li>2. Then assign the same type number value or variable to the operands in the expression.</li> </ol> <p>Makes sure all assignment expressions have the valid type-matching number operands.</p>
ErrorSuggestion0004821F	<p>[Cause] The expression has missing the right parentheses.</p> <p>[Caution] Check the expression in the current project node (SET, IF, WAITFOR, etc.) whether the expression misses any parentheses.</p> <p>[Precaution] This error would only show on the pop up windows, not in the HMI log.</p> <p>[Solution]</p> <ol style="list-style-type: none"> <li>1. Click on the OK button on the pop up windows then make up a right parentheses.</li> <li>2. Makes sure all expressions has the right parentheses.</li> </ol>
ErrorSuggestion00048220	<p>[Cause] The expression has missing the right Bracket when access the array data with index.</p> <p>[Caution] Check the expression in the current project node (SET, IF, WAITFOR, etc.) whether the expression misses any bracket on the right side.</p> <p>[Precaution] This error would only show on the pop up windows, not in the HMI log.</p> <p>[Solution]</p> <ol style="list-style-type: none"> <li>1. Click on the OK button on the pop up windows then make up a right Brackets.</li> <li>2. Makes sure all expressions has right Brackets.</li> </ol>
ErrorSuggestion00048221	<p>[Cause] The expression has missing the right Brace.</p> <p>[Caution] Check the expression in the current project node (SET, IF, WAITFOR, etc.) whether the expression misses any Brace.</p> <p>[Precaution] This error would only show on the pop up windows, not in the HMI log.</p> <p>[Solution]</p> <ol style="list-style-type: none"> <li>1. Click on the OK button on the pop up windows then make up a right Brace.</li> <li>2. Makes sure all expressions has the right Brace.</li> </ol>
ErrorSuggestion00048222	<ol style="list-style-type: none"> <li>1. Please backup the HMI Log and Projects.</li> <li>2. Please contact the original purchase of the manufacturer or a third party designated maintenance unit.</li> </ol>
ErrorSuggestion00048223	<ol style="list-style-type: none"> <li>1. Please backup the HMI Log and Projects.</li> <li>2. Please contact the original purchase of the manufacturer or a third party designated maintenance unit.</li> </ol>
ErrorSuggestion00048224	<ol style="list-style-type: none"> <li>1. Please backup the HMI Log and Projects.</li> <li>2. Please contact the original purchase of the manufacturer or a third party designated maintenance unit.</li> </ol>

ErrorSuggestion00048600	<p>[Cause] Unexpected software issue</p> <p>[Caution] Check if there is any error messages followed</p> <p>[Additional Explanation] This error occurs if and only if there is a unexpected issue on software</p> <p>[Solution]</p> <ol style="list-style-type: none"> <li>1. Export the project file and log file</li> <li>2. Contact with a qualified service engineer for further analysis</li> </ol>
ErrorSuggestion00048601	Please check variable manager, this variable is undefined.
ErrorSuggestion00048602	<p>[Cause]Undefined functions in the expression editor</p> <p>[Caution]</p> <ol style="list-style-type: none"> <li>1. Follow the description on the log and check to see if the variable names and function syntax are correct</li> <li>2. Check to see if any variables used in the expression editor have been deleted from the Variable Manager</li> </ol> <p>[Additional Explanation] This error usually appears as a popped up message in HMI</p> <p>[Solution]</p> <ol style="list-style-type: none"> <li>1. Confirm that the variables used in the expression editor exist and that the proper function syntax has been followed</li> </ol>
ErrorSuggestion00048603	<p>[Cause] The HMI detected a division calculation error during the project running</p> <p>[Caution] Check if any variables as a divisor in the project is assigned a value zero by initial setting or during process</p> <p>[Additional Explanation] It often occurs in the division expression of SET and Display Node, or in the Boolean expression of IF and Gateway Node in the project flow</p> <p>[Solution]</p> <ol style="list-style-type: none"> <li>1. Trigger Robot Stick Reset button or user connected Reset input to restore the error status</li> <li>2. Designing a program mechanism examines that every variable as a divisor and prevent it running if it is assigned zero</li> </ol>
ErrorSuggestion00048604	<p>[Cause] Project Flow contains expression modulo by zero</p> <p>[Caution] Check if any variable used as the divisor of a modulo expression could possibly change to zero during project run</p> <p>[Additional Explanation] Usually, HMI will block the expression (warning message) if it is directly as, e.g., "var_result = var_num1%0"; however, if the expression is written as, e.g., "var_result = var_num1%var_num2", if var_num changes to 0 during project run will trigger this error.</p> <p>[Solution]</p> <ol style="list-style-type: none"> <li>1. Trigger Robot Stick Reset button or user connected Reset input to restore the error status</li> <li>2. Correct the issued expression(s)</li> </ol> <p>Make sure the variables used as the divisor will never be zero</p>
ErrorSuggestion00048605	<p>[Cause] The expression is assigned with a invalid operator in array operations.</p> <p>[Caution] Check if there is any missing index of the array. Or a incorrect operator has been chosen</p> <p>[Precaution] This error would only show on the pop up windows, not in the HMI log.</p> <p>[Additional Explanations]</p> <p>The error code is often triggered between two arrays' operation without index assigning:</p> <p>In assignment expression of project node (SET).</p> <p>Incorrect operators: (" += ", " -= ", " *= ", " /= ") (i.e. var_array_A += var_array_B)</p> <p>Correct operators: (" = ") (i.e. var_array_A = var_array_B)</p> <p>In comparison expression of project node (IF).</p> <p>Incorrect operators: (" &gt; ", " &gt;= ", " &lt; ", " &lt;= ") (i.e. var_array_A &gt;= var_array_B)</p> <p>Correct operators: ("==" or "!=") (i.e. var_array_A == var_array_B)</p>

ErrorSuggestion00048606	<p>[Solution]</p> <ol style="list-style-type: none"> <li>1. Click on the OK button on the pop up windows then assign the suitable operators.</li> <li>2. Makes sure all assignment and comparison expressions have the valid operator.</li> </ol> <p>[Cause] The HMI detected a invalid index used on a array variable during project run</p> <p>[Caution] Check if the value any variables used as a array index is out of range or a negative quantity</p> <p>[Additional explanation] The variable used as a array index is invalid in value possibly by initialization or assigned by SET node during project run</p>
ErrorSuggestion00048607	<p>[Solution]</p> <ol style="list-style-type: none"> <li>1. Trigger Robot Stick Reset button or user connected Reset input to restore the error status</li> <li>2. Make the initial value of all index variables is correct</li> <li>3. Make sure the value of all index variables would not be change incorrectly by any SET node</li> </ol> <p>[Cause] The operand in the assignment expression is assigned with a different type number.</p> <p>[Caution] Check if the operand on the left side of the assignment operator (" = ") is type matching with the right side one in the current project node (SET)</p> <p>[Precaution] a error message 『Warning for Number Value may be missing』 would show on the pop up windows when project is edited.</p> <p>If ignore it, this error code would show with the warning message in the HMI log during project running.</p> <p>[Additional Explanation]</p> <p>Number related expression should have the following instruction when using different types, i.e. :</p> <p>Correct :</p> <ol style="list-style-type: none"> <li>1. double = int</li> <li>2. float = int</li> <li>3. double = float</li> </ol> <p>Incorrect :</p> <ol style="list-style-type: none"> <li>1. int = double</li> <li>2. int = float</li> <li>3. float = double</li> </ol>
ErrorSuggestion00048608	<p>[Solution]</p> <ol style="list-style-type: none"> <li>1. Trigger Robot Stick Reset button or user connected Reset input to restore the error status</li> <li>2. Then assign the same type number value or variable to the operands in the expression.</li> </ol> <p>Makes sure all assignment expressions have the valid type-matching number operands.</p>
ErrorSuggestion00048609	<ol style="list-style-type: none"> <li>1. Please backup the HMI Log and Projects.</li> <li>2. Please contact the original purchase of the manufacturer or a third party designated maintenance unit.</li> </ol> <p>[Cause] The expression is assigned with a invalid operand.</p> <p>[Caution] Check if the operand in the left side of the assignment operator (" = ") is type matching with the right side one in the current project node (SET)</p> <p>[Precaution] This error would only show on the pop up windows, not in the HMI log.</p>
ErrorSuggestion0004860A	<p>[Solution]</p> <ol style="list-style-type: none"> <li>1. Click on the OK button on the pop up windows then assign the same type value or variable to the operand in the expression.</li> <li>2. Makes sure all assignment of expressions have the valid type-matching operand.</li> </ol> <p>[Cause] There is a invalid usage on a expression</p> <p>[Caution] Check if the data type is matched from both sides of a expression, especially on a IF node</p> <p>[Precaution] This error would only show on the pop up windows, not in the HMI log.</p> <p>[Additional Explanation] This error would be triggered if there is a invalid symbol usage and only have it on a expression, for example:</p> <p>string == ###</p>

	<p>[Solution]</p> <ol style="list-style-type: none"> <li>1. Click on the OK button on the pop up windows.</li> <li>2. Correct the expression</li> </ol> <p>Check and confirm the type is correct while creating a expression.</p>
ErrorSuggestion0004860B	<p>[Cause] There is a invalid usage on a expression</p> <p>[Caution] Check if the data type is matched from both sides of a expression, especially on a IF node</p> <p>[Precaution] This error would only show on the pop up windows, not in the HMI log.</p> <p>[Additional Explanation] This error would be triggered if there is a invalid symbol usage and only have it on a expression, for example: string == ###</p> <p>[Solution]</p> <ol style="list-style-type: none"> <li>1. Click on the OK button on the pop up windows.</li> <li>2. Correct the expression</li> </ol> <p>Check and confirm the type is correct while creating a expression.</p>
ErrorSuggestion00048610	Please check call function stack depth, eg, call function within sub function or recursive function call
ErrorSuggestion00048A00	Please wait some time, and retry to play project
ErrorSuggestion00048B00	<p>[Cause] Unexpected software issue</p> <p>[Caution] Check if there is any error messages followed</p> <p>[Additional Explanation] This error occurs if and only if there is a unexpected issue on software</p> <p>[Solution]</p> <ol style="list-style-type: none"> <li>1. Export the project file and log file</li> <li>2. Contact with a qualified service engineer for further analysis</li> </ol>
ErrorSuggestion00048B01	<ol style="list-style-type: none"> <li>1. Please backup the HMI Log and Projects.</li> <li>2. Please contact the original purchase of the manufacturer or a third party designated maintenance unit.</li> </ol>
ErrorSuggestion00048B02	<ol style="list-style-type: none"> <li>1. Please backup the HMI Log and Projects.</li> <li>2. Please contact the original purchase of the manufacturer or a third party designated maintenance unit.</li> </ol>
ErrorSuggestion00048B03	Error on Set BreakPoints
ErrorSuggestion00048B10	Please check variable manager, this variable is undefined.
ErrorSuggestion00048B11	<p>[Cause] Undefined functions in the expression editor</p> <p>[Caution]</p> <ol style="list-style-type: none"> <li>1. Follow the description on the log and check to see if the variable names and function syntax are correct</li> <li>2. Check to see if any variables used in the expression editor have been deleted from the Variable Manager</li> </ol> <p>[Additional Explanation] This error usually appears as a popped up message in HMI</p> <p>[Solution]</p> <ol style="list-style-type: none"> <li>1. Confirm that the variables used in the expression editor exist and that the proper function syntax has been followed</li> </ol>
ErrorSuggestion00048B12	functions is not exist
ErrorSuggestion00048B13	<p>[Cause] The HMI detected a invalid index used on a array variable during project run</p> <p>[Caution] Check if the value any variables used as a array index is out of range or a negative quantity</p> <p>[Additional explanation] The variable used as a array index is invalid in value possibly by initialization or assigned by SET node during project run</p> <p>[Solution]</p> <ol style="list-style-type: none"> <li>1. Trigger Robot Stick Reset button or user connected Reset input to restore the error status</li> <li>2. Make the initial value of all index variables is correct</li> <li>3. Make sure the value of all index variables would not be change incorrectly by any SET node</li> </ol>
ErrorSuggestion00048B14	Please check array function data type
ErrorSuggestion00048B15	Please check array size
ErrorSuggestion00048B16	Please check array function start index

ErrorSuggestion00048B17	<p>[Cause] The operand in the assignment expression is assigned with a different type number.</p> <p>[Caution] Check if the operand on the left side of the assignment operator (" = ") is type matching with the right side one in the current project node (SET)</p> <p>[Precaution] a error message 『Warning for Number Value may be missing』 would show on the pop up windows when project is edited.</p> <p>If ignore it, this error code would show with the warning message in the HMI log during project running.</p> <p>[Additional Explanation]</p> <p>Number related expression should have the following instruction when using different types, i.e. :</p> <p>Correct :</p> <ol style="list-style-type: none"> <li>1. double = int</li> <li>2. float = int</li> <li>3. double = float</li> </ol> <p>Incorrect :</p> <ol style="list-style-type: none"> <li>1. int = double</li> <li>2. int = float</li> <li>3. float = double</li> </ol> <p>[Solution]</p>
	<ol style="list-style-type: none"> <li>1. Trigger Robot Stick Reset button or user connected Reset input to restore the error status</li> <li>2. Then assign the same type number value or variable to the operands in the expression.</li> </ol>
	<p>Makes sure all assignment expressions have the valid type-matching number operands.</p>
ErrorSuggestion00048B20	Please check UNC Path is valid
ErrorSuggestion00048B21	Please check UNC Path could be access
ErrorSuggestion00048B22	Please check disk partition attribute information
ErrorSuggestion00048B23	Please check disk partition attribute information
ErrorSuggestion00048B24	Please check disk partition attribute information
ErrorSuggestion00048B25	Please check disk partition attribute information
ErrorSuggestion00048B26	Please check disk partition attribute information
ErrorSuggestion00048B27	Please check file is exist
ErrorSuggestion00048B28	Please check file size
ErrorSuggestion00048B29	Please check file attribute is not read only
ErrorSuggestion00048B2A	Please check Vision Images folder
ErrorSuggestion00048B2B	Please check UNC Path is valid for Vision Images
ErrorSuggestion00048B30	Please check whether COM port settings of Serial Port are correct.
ErrorSuggestion00048B31	<p>[Cause] Network device or IP address port is invalid.</p> <p>[Solution]</p> <ol style="list-style-type: none"> <li>1. Please check the Internet device function and connection.</li> <li>2. Please check the IP setting.</li> </ol>
ErrorSuggestion00048B32	<p>[Cause] System failed to open a Modbus master</p> <p>[Caution]</p> <ol style="list-style-type: none"> <li>1. Check if the robot is connected to the network, including wire connection, and the quality of the network</li> <li>2. Check if the Setting\Network Setting is correct or not (if using Modbus TCP)</li> <li>3. Check if the settings on Modbus TCP Device is correct or not , including: ip address, port, address, signal type, etc.</li> <li>4. Check if the settings on Modbus RTU Device is correct or not , including: ComPort, Baud Rate, DataBits, StopBits, Parity Check, address, signal type, etc.</li> </ol> <p>[Additional Explanation] For Modbus TCP, this usually happens because the robot is not connected to the network or network settings (especially, IP Address and Port)</p> <p>[Additional Explanation] For Modbus RTU, this usually happens because the ComPort selected has already been</p>

	used by other functions (normal usage on Serial Port)
	[Solution]
	1. Confirm and correct the settings of Modbus Devices, then enable Modbus again on Settings\Modbus
	2. Regularly check the quality of the network, including hardware.
	3. It is suggested to have knowledge on Modbus before usage
ErrorSuggestion00048B33	[Cause] System failed to read data through Modbus
	[Caution]
	1. Check if the robot is connected to the network, including wire connection, and the quality of the network
	2. Check if the Setting\Network Setting is correct or not (if using Modbus TCP)
	3. Check if the settings on Modbus TCP Device is correct or not , including: ip address, port, address, signal type, etc.
	4. Check if the settings on Modbus RTU Device is correct or not , including: ComPort, Baud Rate, DataBits, StopBits, Parity Check, address, signal type, etc.
	[Solution]
	1. Confirm and correct the settings of Modbus Devices, then enable Modbus again on Settings\Modbus
	2. Regularly check the quality of the network, including hardware.
	3. It is suggested to have knowledge on Modbus before usage
ErrorSuggestion00048B34	[Cause] System failed to write data through Modbus
	[Caution]
	1. Check if the robot is connected to the network, including wire connection, and the quality of the network
	2. Check if the Setting\Network Setting is correct or not (if using Modbus TCP)
	3. Check if the settings on Modbus TCP Device is correct or not , including: ip address, port, address, signal type, etc.
	4. Check if the settings on Modbus RTU Device is correct or not , including: ComPort, Baud Rate, DataBits, StopBits, Parity Check, address, signal type, etc.
	[Solution]
	1. Confirm and correct the settings of Modbus Devices, then enable Modbus again on Settings\Modbus
	2. Regularly check the quality of the network, including hardware.
	3. It is suggested to have knowledge on Modbus before usage
ErrorSuggestion00048B35	[Cause] System cannot detect the sensor through serial port
	[Caution] Check if the USB-Serial converter cable is loosen
	[Additional Explanation] This error only happens on force control related node (smart insert, polish, etc) using force torque with rs232 interface
	[Additional Explanation] COM Port generated by USB-Serial convertor would be deleted if the cable is loosen
	[Precaution] The Serial Port number might change if the convertor is plugged onto a different usb port
	[Solution]
	1. Trigger Robot Stick Reset button or user connected Reset input to restore the error status
	2. Reconnect the convertor back to the SAME usb port
	3. It is not suggested to use USB-Serial convertor
	4. If it is necessary, please make sure the convertor is always plugged well
ErrorSuggestion00048B36	Please check Ethernet Slave (TCP/IP server) is enabled
ErrorSuggestion00048B37	Please check Ethernet Slave (TCP/IP server) item name is valid
ErrorSuggestion00048B38	Please check Ethernet Slave (TCP/IP server) item value is valid
ErrorSuggestion00048B40	Please check parameterized key is exist
ErrorSuggestion00048B41	Please check parameterized value is valid
ErrorSuggestion00048B42	Please check parameterized property is support
ErrorSuggestion00048B43	Please check HW version is 3.2 or above
ErrorSuggestion00048B50	[Cause] The function syntax is invalid for Thread
	[Solution] Please remove the invalid function syntax call by thread



ErrorSuggestion00048B51	[Cause] The function syntax is invalid for TM AI+ AOI Edge [Solution] Please remove the invalid function syntax call by TM AI+ AOI Edge
ErrorSuggestion00048B52	Please check Motion Parameter value for Expression motion function
ErrorSuggestion00048B53	Please check Parameter value for Expression function
ErrorSuggestion00048E00	Warning
ErrorSuggestion00048E01	[Cause] HMI detected that one or more Warning situations during the project running. [Caution] The value of n in the string "Warning Counter(n)" showing in the HMI log displays that how many warning situations have during the project running. [Additional Explanation] Some warning information usually appears as a popped up message during flow editing, but the HMI could endure these warnings. If ignore it, the HMI log still shows these warnings to user during running the project. These warnings may be the following below: (1) Warning, include variable in String Format (2) Warning for Number Value may be missing (3) ..etc. [Solution] 1. (in flow editing) Click on the OK button on the pop up windows. 2. (in project running) Stop the running project through pressing the Stop button on Stick 3. Check these warnings one by one and clear them. 4. Check if data type mismatch of assignment variables in the flow.
ErrorSuggestion00048E02	[Cause] System detected the text characters that may be strings but are without double quotes [Caution] 1. Check if there are any strings used in the expression editor that have no double quotes 2. Check to see if any variables used in the expression editor have been deleted from the Variable Manager [Additional Explanation] This error usually appears as a popped up message in HMI [Solution] Confirm that there are double quotes around all strings and that all variables used in the expression editor exist 1. Make sure to use double quotes when defining strings 2. Avoid deleting variables that are still in use
ErrorSuggestion00048E03	Warning for Number Format to String Format
ErrorSuggestion00048E04	Warning for String Format To Number Format
ErrorSuggestion00048E05	[Cause] The operand in the assignment expression is assigned with a different type number. [Caution] Check if the operand in the left side of the assignment operator (" = ") is type matching with the right side one in the current project node (SET) [Precaution] This error would show on the pop up windows, not in the HMI log. [Additional Explanation] Number related expression should have the following instruction when using different types, i.e. : Correct : 1. double = int, 2. float = int 3. double = float Incorrect : 1. int = double 2. int = float 3. float = double [Solution] 1. Click on the OK button on the pop up windows then assign the same type number value or variable to the operands



ErrorSuggestion00048E06

in the expression.

2. Makes sure all assignment expressions have the valid type-matching number operands.

ErrorSuggestion00048E07

Warning for String Format include Variables

ErrorSuggestion00048E08

Warning for String Format include Variables

[Cause] The operand in the assignment expression is assigned with a different type number.

[Caution] Check if the operand in the left side of the assignment operator (" = ") is type matching with the right side one in the current project node (SET)

[Precaution] This error would show on the pop up windows, not in the HMI log.

[Additional Explanation]

Number related expression should have the following instruction when using different types, i.e. :

Correct :

1. double = int,
2. float = int
3. double = float

Incorrect :

1. int = double
2. int = float
3. float = double

[Solution]

1. Click on the OK button on the pop up windows then assign the same type number value or variable to the operands in the expression.

2. Makes sure all assignment expressions have the valid type-matching number operands.

ErrorSuggestion00048F00

[Cause] Network address is not available on Log node

[Caution]

1. Check the network setting on Log node if the address is accessible
2. Check if the network target requires any advanced authority
3. Check if there is any other issue on the network, such as loosen Ethernet cable

[Additional Explanation]

This error usually appears in

1. Log node in project flow
2. The local network path format  
(i.e. \\192.168.1.1\sharedfolder)

This error would be triggered when system fails to connect to the network path

[Solution]

1. Trigger Robot Stick Reset button or user connected Reset input to restore the error status
2. Make sure the network path could be access
3. Make sure the network is accessible

ErrorSuggestion00048F01

Warning for file size is too large

ErrorSuggestion0004E000

[Cause] Exception error.

[Solution]

1. Retry again.
2. Restart the robot.
3. If the problem still occur, contact a qualified service engineer for further analysis.

ErrorSuggestion0004E001

[Cause] Program exception error.

[Solution]

1. Retry again.

	<ol style="list-style-type: none"> <li>2. Restart the robot.</li> <li>3. If the problem still occur, contact a qualified service engineer for further analysis.</li> </ol>
ErrorSuggestion0004E002	<p>[Cause] Safety initialization error.</p> <p>[Solution]</p> <ol style="list-style-type: none"> <li>1. Restart the robot.</li> <li>2. If the problem still occur, contact a qualified service engineer for further analysis.</li> </ol>
ErrorSuggestion0004E003	<p>[Cause] Safety settings Apply command error.</p> <p>[Solution]</p> <ol style="list-style-type: none"> <li>1. Re-apply the safety settings again.</li> <li>2. If the problem still occur, contact a qualified service engineer for further analysis.</li> </ol>
ErrorSuggestion0004E004	<p>[Cause] Safety settings Get command error.</p> <p>[Solution]</p> <ol style="list-style-type: none"> <li>1. Retry again.</li> <li>2. Restart the robot.</li> <li>3. If the problem still occur, contact a qualified service engineer for further analysis.</li> </ol>
ErrorSuggestion0004E005	<p>[Cause] Safety settings Update command error.</p> <p>[Solution]</p> <ol style="list-style-type: none"> <li>1. Restart the robot.</li> <li>2. If the problem still occur, contact a qualified service engineer for further analysis.</li> </ol>
ErrorSuggestion0004E006	<p>[Cause] Safety settings Confirm command error.</p> <p>[Solution]</p> <ol style="list-style-type: none"> <li>1. Re-confirm the safety settings again.</li> <li>2. If the problem still occur, contact a qualified service engineer for further analysis.</li> </ol>
ErrorSuggestion0004E007	<p>[Cause] Safety module Login command error.</p> <p>[Solution]</p> <ol style="list-style-type: none"> <li>1. Re-login the safety module again.</li> <li>2. If the problem still occur, contact a qualified service engineer for further analysis.</li> </ol>
ErrorSuggestion0004E008	<p>[Cause] Safety module Login command duplicated, the safety module is already logged in by other device.</p> <p>[Solution]</p> <ol style="list-style-type: none"> <li>1. Logout the other device first and re-login with desired device again.</li> <li>2. If the problem still occur, contact a qualified service engineer for further analysis.</li> </ol>
ErrorSuggestion0004E009	<p>[Cause] Safety module Login command duplicated, the safety module is already logged in by other device.</p> <p>[Solution]</p> <ol style="list-style-type: none"> <li>1. Logout the other device first and re-login with desired device again.</li> <li>2. If the problem still occur, contact a qualified service engineer for further analysis.</li> </ol>
ErrorSuggestion0004E00A	<p>[Cause] Safety module not logging in.</p> <p>[Solution]</p> <ol style="list-style-type: none"> <li>1. Login the safety module with the valid password.</li> <li>2. If the problem still occur, contact a qualified service engineer for further analysis.</li> </ol>
ErrorSuggestion0004E00B	<p>[Cause] Safety module Logout command error.</p> <p>[Solution]</p> <ol style="list-style-type: none"> <li>1. Re-logout the safety module again.</li> <li>2. If the problem still occur, contact a qualified service engineer for further analysis.</li> </ol>
ErrorSuggestion0004E00C	<p>[Cause] Safety password Set command error.</p> <p>[Solution]</p> <ol style="list-style-type: none"> <li>1. Re-set the safety password again.</li> <li>2. If the problem still occur, contact a qualified service engineer for further analysis.</li> </ol>

ErrorSuggestion0004E00D	[Cause] Safety password Verification command error. [Solution] 1. Re-set the safety password with the right format again. 2. If the problem still occur, contact a qualified service engineer for further analysis.
ErrorSuggestion0004E00E	[Cause] Invalid safety password. [Solution] 1. Please check the type-in safety password format. 2. If the problem still occur, contact a qualified service engineer for further analysis.
ErrorSuggestion0004E00F	[Cause] Operation Mode Change command error. [Solution] 1. Re-change the operation mode again. 2. If the problem still occur, contact a qualified service engineer for further analysis.
ErrorSuggestion0004E010	[Cause] Robot Stick Enable/disabled Status Change command error. [Solution] 1. Re-change the Robot Stick Enable/disabled Status again. 2. If the problem still occur, contact a qualified service engineer for further analysis.
ErrorSuggestion0004E011	[Cause] Safety password Reset command error. [Solution] 1. Re-try again. 2. If the problem still occur, contact a qualified service engineer for further analysis.
ErrorSuggestion0004E012	[Cause] Safety module information Get command error. [Solution] 1. Restart the robot. 2. If the problem still occur, contact a qualified service engineer for further analysis.
ErrorSuggestion0004E013	[Cause] Safety module information Update command error. [Solution] 1. Restart the robot. 2. If the problem still occur, contact a qualified service engineer for further analysis.
ErrorSuggestion0004E014	[Cause] Safety settings Update command error. [Solution] 1. Re-try again. 2. If the problem still occur, contact a qualified service engineer for further analysis.
ErrorSuggestion0004E015	[Cause] Safety command setting Get command error. [Solution] 1. Re-try again. 2. Restart the robot. 3. If the problem still occur, contact a qualified service engineer for further analysis.
ErrorSuggestion0004E016	[Cause] Safety parameters of each safety module mismatched. [Precaution] Certain robot motion function/command will be disabled. [Solution] 1. Restart the robot. 2. Re-apply the safety settings again. 3. If the problem still occur, contact a qualified service engineer for further analysis.
ErrorSuggestion0004E017	[Cause] Safety module versions of each safety module mismatched [Precaution] Certain robot motion function/command will be disabled. [Solution]

ErrorSuggestion0004E018	<ol style="list-style-type: none"> <li>1. Restart the robot.</li> <li>2. If the problem still occur, contact a qualified service engineer for further analysis.</li> </ol> <p>[Cause] Safety System Version Mismatch</p> <p>[Precaution] Certain robot motion function/command will be disabled.</p> <p>[Solution]</p> <ol style="list-style-type: none"> <li>1. Restart the robot.</li> <li>2. If the problem still occur, contact a qualified service engineer for further analysis.</li> </ol>
ErrorSuggestion0004E019	<p>[Cause] Safety System Version Changed</p> <p>[Precaution] Certain robot motion function/command will be disabled.</p> <p>[Solution]</p> <ol style="list-style-type: none"> <li>1. Please follow the instruction to re-configure the safety settings.</li> <li>2. Please follow the instruction to re-configure the safety passwords.</li> </ol>
ErrorSuggestion0004E01A	<p>[Cause] Safety passwords of each safety module mismatched.</p> <p>[Precaution] Certain robot motion function/command will be disabled.</p> <p>[Solution]</p> <ol style="list-style-type: none"> <li>1. Reset the safety password again.</li> <li>2. Restart the robot.</li> <li>3. If the problem still occur, contact a qualified service engineer for further analysis.</li> </ol>
ErrorSuggestion0004E01B	<p>[Cause] Safety time stamp Set command error.</p> <p>[Solution]</p> <ol style="list-style-type: none"> <li>1. Re-apply the safety settings again.</li> <li>2. If the problem still occur, contact a qualified service engineer for further analysis.</li> </ol>
ErrorSuggestion0004E01C	<p>[Cause] Safety Calibration File Apply command error.</p> <p>[Solution]</p> <ol style="list-style-type: none"> <li>1. Contact a qualified service engineer for further analysis.</li> </ol>
ErrorSuggestion0004E01D	<p>[Cause] Safety Calibration File missing.</p> <p>[Solution]</p> <ol style="list-style-type: none"> <li>1. Contact a qualified service engineer for further analysis.</li> </ol>
ErrorSuggestion0004E01E	<p>[Cause] Safety Calibration File Get command error.</p> <p>[Solution]</p> <ol style="list-style-type: none"> <li>1. Restart the robot.</li> <li>2. If the problem still occur, contact a qualified service engineer for further analysis.</li> </ol>
ErrorSuggestion0004E01F	<p>[Cause] Invalid Safety Configuration File name.</p> <p>[Solution]</p> <ol style="list-style-type: none"> <li>1. Please check the valid Safety Configuration File name.</li> <li>2. If the problem still occur, contact a qualified service engineer for further analysis.</li> </ol>
ErrorSuggestion0004E020	<p>[Cause] Invalid Safety Configuration File path.</p> <p>[Solution]</p> <ol style="list-style-type: none"> <li>1. Please check the valid Safety Configuration File path.</li> <li>2. If the problem still occur, contact a qualified service engineer for further analysis.</li> </ol>
ErrorSuggestion0004E021	<p>[Cause] Safety Configuration File Save command error.</p> <p>[Solution]</p> <ol style="list-style-type: none"> <li>1. Re-save the Safety Configuration File again.</li> <li>2. If the problem still occur, contact a qualified service engineer for further analysis.</li> </ol>
ErrorSuggestion0004E022	<p>[Cause] Safety Configuration File Save command error.</p> <p>[Solution]</p>

ErrorSuggestion0004E023	<ol style="list-style-type: none"> <li>1. Re-save the Safety Configuration File again.</li> <li>2. If the problem still occur, contact a qualified service engineer for further analysis.</li> </ol> <p>[Cause] Safety Configuration File Load command error.</p> <p>[Solution]</p> <ol style="list-style-type: none"> <li>1. Re-load the Safety Configuration File again.</li> <li>2. If the problem still occur, contact a qualified service engineer for further analysis.</li> </ol>
ErrorSuggestion0004E024	<p>[Cause] Safety Configuration File Load command error.</p> <p>[Solution]</p> <ol style="list-style-type: none"> <li>1. Re-load the Safety Configuration File again.</li> <li>2. If the problem still occur, contact a qualified service engineer for further analysis.</li> </ol>
ErrorSuggestion0004E025	<p>[Cause] Safety Configuration File Delete command error.</p> <p>[Solution]</p> <ol style="list-style-type: none"> <li>1. Re-delete the Safety Configuration File again.</li> <li>2. If the problem still occur, contact a qualified service engineer for further analysis.</li> </ol>
ErrorSuggestion0004E026	<p>[Cause] Safety Configuration File Delete command error.</p> <p>[Solution]</p> <ol style="list-style-type: none"> <li>1. Re-delete the Safety Configuration File again.</li> <li>2. If the problem still occur, contact a qualified service engineer for further analysis.</li> </ol>
ErrorSuggestion0004E027	<p>[Cause] Safety System Version Mismatch between Safety Configuration File and Current Operation Safety System</p> <p>[Solution]</p> <ol style="list-style-type: none"> <li>1. Please check if the parameters in Safety Configuration File are correct.</li> <li>2. Re-save the Safety Configuration File again.</li> <li>3. If the problem still occur, contact a qualified service engineer for further analysis.</li> </ol>
ErrorSuggestion0004E028	<p>[Cause] Set Com Port Fail</p> <p>[Solution]</p> <ol style="list-style-type: none"> <li>1. Re-try again.</li> <li>2. If the problem still occur, contact a qualified service engineer for further analysis.</li> </ol>
ErrorSuggestion0004E029	<p>[Cause] Safety Module Serial Port Not working.</p> <p>[Solution]</p> <ol style="list-style-type: none"> <li>1. Restart the robot.</li> <li>2. If the problem still occur, contact a qualified service engineer for further analysis.</li> </ol>
ErrorSuggestion0004F000	General information
ErrorSuggestion00050000	No Error
ErrorSuggestion0005F051	<p>[Cause] Safety System Version Changed</p> <p>[Precaution] Certain robot motion function/command will be disabled.</p> <p>[Solution]</p> <ol style="list-style-type: none"> <li>1. Please follow the instruction to re-configure the safety settings.</li> <li>2. Please follow the instruction to re-configure the safety passwords.</li> </ol>
ErrorSuggestion0005F052	<p>[Cause] Robot has detected a overshoot of V phase current on the motor</p> <p>[Caution]</p> <ol style="list-style-type: none"> <li>1. Check the header of the error code to see which motor is with this issue</li> <li>2. Check if the robot is run with payload out of spec. and also in high speed</li> <li>3. Check if the safety settings of the robot</li> </ol> <p>[Additional Explanation] If the robot is driven and accelerate fast, current of the motor will overshoot and trigger this error</p> <p>[Additional Explanation] This is usually be triggered when running the robot with a heavy payload with high speed which is nearly or already out of spec.</p>

ErrorSuggestion0005F053	<p>[Additional Explanation] Another reason may be there is dysfunction on the electronics on the motors</p> <p>[Solution]</p> <ol style="list-style-type: none"> <li>1. Shut down and reboot the robot</li> <li>2. Make sure the payload (including the tool) is within the spec.</li> <li>3. Adjust the speed or movement to prevent the risk of having a single joint accelerate too fast</li> <li>4. If it still happens, export the Logs, Project and TCP used, and contact to your service engineer</li> </ol> <p>[Cause]Robot has detected a overshoot of W phase current on the motor</p> <p>[Caution]</p> <ol style="list-style-type: none"> <li>1. Check the header of the error code to see which motor is with this issue</li> <li>2. Check if the robot is run with payload out of spec. and also in high speed</li> <li>3. Check if the safety settings of the robot</li> </ol> <p>[Additional Explanation] If the robot is driven and accelerate fast, current of the motor will overshoot and trigger this error</p> <p>[Additional Explanation] This is usually be triggered when running the robot with a heavy payload with high speed which is nearly or already out of spec.</p>
ErrorSuggestion0005F054	<p>[Additional Explanation] Another reason may be there is dysfunction on the electronics on the motors</p> <p>[Solution]</p> <ol style="list-style-type: none"> <li>1. Shut down and reboot the robot</li> <li>2. Make sure the payload (including the tool) is within the spec.</li> <li>3. Adjust the speed or movement to prevent the risk of having a single joint accelerate too fast</li> <li>4. If it still happens, export the Logs, Project and TCP used, and contact to your service engineer</li> </ol> <p>[Cause]Robot has detected the current on DCBUS went too high suddenly.</p> <p>[Caution]</p> <ol style="list-style-type: none"> <li>1. The speed (ABS/project speed) is too fast.</li> <li>2. Check whether there is any collision while robot moving.</li> </ol> <p>[Additional Explanations] If robot is moving in a high speed in some movement or pose, it would cause this error. And if robot has collisions, it would cause the current became abnormal.</p> <p>[Solution][General User]</p> <ol style="list-style-type: none"> <li>1. Slow down the speed (ABS/project speed).</li> <li>2. Avoid any collision while robot is moving.</li> <li>3. After restart the robot, the problem still occur, contact a qualified service engineer for further analysis.</li> </ol>
ErrorSuggestion0005F055	<p>[Cause]</p> <ol style="list-style-type: none"> <li>1. Power supply is not stable.</li> <li>2. Robot moves in high speed, current is higher, voltage loss getting higher.(Vinput-Vloss=V for DC bus)</li> <li>3. Power connector problem, consume too much power</li> </ol> <p>[Additional Explanation] When robot is working and detects the voltage of DC bus is low, it will report this error</p> <p>[Solution]</p> <ol style="list-style-type: none"> <li>1. Power off the robot</li> <li>2. Check Robot Cable and its connector before power on again</li> <li>3. Reduce Robot speed if necessary</li> </ol> <p>Make sure power source is stable</p>
ErrorSuggestion0005F056	<p>[Cause]Robot detect the voltage on DCBUS is higher than spec.</p> <p>[Caution]Check whether there are others error log along with this error.</p> <p>[Additional Explanation] There may be a variety of reasons that cause a high voltage, for example:</p> <ol style="list-style-type: none"> <li>1. The robot move too fast with the current project (with heavy payload)</li> <li>2. Power eater modules is abnormal</li> <li>3. etc.</li> </ol>

	<p>[Precaution] Power off and unplug the power cable before opening the control box for items checking</p> <p>[Solution]</p> <ol style="list-style-type: none"> <li>1. Make sure the robot would not be collided and be placed on a unstable platform.</li> <li>2. Make sure project speed with payload is within the specification.</li> <li>3. After restart the robot, the problem still occur, contact a qualified service engineer for further analysis</li> </ol>
ErrorSuggestion0005F057	<ol style="list-style-type: none"> <li>1. Please try to restart the robot.</li> <li>2. If the restart is invalid, please contact the original purchase or third-party designated maintenance units.</li> </ol>
ErrorSuggestion0005F058	<p>[Cause] DC to DC component on Join PCB is damaged</p> <p>[Additional Explanation] When detect voltage of 1.65V is abnormal, it will report this error</p> <p>[Solution]</p> <ol style="list-style-type: none"> <li>1. Export the log file</li> <li>2. Contact a qualified service engineer</li> </ol>
ErrorSuggestion0005F059	<p>[Cause] DC to DC component on Join PCB is damaged</p> <p>[Additional Explanation] When detect voltage of 12V is abnormal, it will report this error</p> <p>[Solution]</p> <ol style="list-style-type: none"> <li>1. Export the log file</li> <li>2. Contact a qualified service engineer</li> </ol>
ErrorSuggestion0005F05A	<p>[Cause] DC to DC component on Join PCB is damaged</p> <p>[Additional Explanation] When detect voltage of 6V is abnormal, it will report this error</p> <p>[Solution]</p> <ol style="list-style-type: none"> <li>1. Export the log file</li> <li>2. Contact a qualified service engineer</li> </ol>
ErrorSuggestion0005F05B	<p>[Cause] DC to DC component on Join PCB is damaged</p> <p>[Additional Explanation] When detect voltage of 3.3V is abnormal, it will report this error</p> <p>[Solution]</p> <ol style="list-style-type: none"> <li>1. Export the log file</li> <li>2. Contact a qualified service engineer</li> </ol>
ErrorSuggestion0005F05C	<p>[Cause] DC to DC component on Join PCB is damaged</p> <p>[Additional Explanation] When detect voltage of 1.2V is abnormal, it will report this error</p> <p>[Solution]</p> <ol style="list-style-type: none"> <li>1. Export the log file</li> <li>2. Contact a qualified service engineer</li> </ol>
ErrorSuggestion0005F05D	<p>Please contact the original purchase of the manufacturer or a third party designated maintenance unit.</p>
ErrorSuggestion0005F061	<p>[Cause] The speed command is too large</p> <p>[Solution]</p> <ol style="list-style-type: none"> <li>1. Shut down and reboot the robot</li> <li>2. Reduce the motion speed, check the flow and the speed and posture in each node</li> <li>3. If it still happens, export the Logs, Project and TCP used, and contact to your service engineer</li> </ol>
ErrorSuggestion0005F062	<p>[Cause] The deviation between target and current position is too large</p> <p>[Solution]</p> <ol style="list-style-type: none"> <li>1. Shut down and reboot the robot</li> <li>2. Reduce the motion speed, check the flow, speed and posture in each node</li> <li>3. If it still happens, export the Logs, Project and TCP used, and contact to your service engineer</li> </ol>
ErrorSuggestion0005F063	<p>[Cause] The motor output command rises sudden and triggers motor hold protection</p> <p>[Caution]</p> <ol style="list-style-type: none"> <li>1. Check if there robot has collided to the surroundings seriously</li> <li>2. Check the description of this error code to see which joint it belongs to</li> </ol>

ErrorSuggestion0005F064	<p>[Additional Explanation] When the robot collides to a solid object in a high speed, some of the joints may suffer a great torque on them and this causes the motor current raise rapidly and trigger this error</p> <p>[Precaution] Do not drive the joint manually when this error occurs, which might damage the joint</p> <p>[Solution]</p> <ol style="list-style-type: none"> <li>1. Shut down and reboot the robot</li> <li>2. Adjust the payload, safety settings, speed and see if the issue still happens</li> <li>3. Make sure the payload (including the tool) is within the spec.</li> <li>4. Adjust the speed or movement to prevent the risk of having a single joint accelerate too fast</li> <li>5. If it still happens, export the Logs, Project and TCP used, and contact to your service engineer</li> <li>6. Make sure the robot will not collide with the surroundings during project run</li> </ol> <p>[Cause] The motor current rises sudden and triggers motor hold protection</p> <p>[Caution]</p> <ol style="list-style-type: none"> <li>1. Check if there robot has collided to the surroundings seriously</li> <li>2. Check the description of this error code to see which joint it belongs to</li> </ol>
ErrorSuggestion0005F071	<p>[Additional Explanation] When the robot collides to a solid object in a high speed, some of the joints may suffer a great torque on them and this causes the motor current raise rapidly and trigger this error</p> <p>[Precaution] Do not drive the joint manually when this error occurs, which might damage the joint</p> <p>[Solution]</p> <ol style="list-style-type: none"> <li>1. Shut down and reboot the robot</li> <li>2. Adjust the payload, safety settings, speed and see if the issue still happens</li> <li>3. Make sure the payload (including the tool) is within the spec.</li> <li>4. Adjust the speed or movement to prevent the risk of having a single joint accelerate too fast</li> <li>5. If it still happens, export the Logs, Project and TCP used, and contact to your service engineer</li> <li>6. Make sure the robot will not collide with the surroundings during project run</li> </ol> <p>[Cause] Hardware Failure</p> <p>[Caution]</p> <p>[Additional Explanation] This error is not likely happens, mostly because of hardware issue</p> <p>[Solution]</p> <ol style="list-style-type: none"> <li>1. Export the Logs</li> <li>2. Contact a qualified service engineer for further analysis</li> </ol>
ErrorSuggestion0005F072	<p>[Cause] Robot detect the temperature on PCB is higher than spec.</p> <p>[Caution]</p> <ol style="list-style-type: none"> <li>1. Check if the environment temperature is higher than the spec. while robot moving.</li> <li>2. Check the temperature on View-&gt;Status</li> </ol> <p>[Additional Explanation] The temperature would rise during robot operating and the work space temperature will affect as well.</p> <p>[Solution]</p> <ol style="list-style-type: none"> <li>1. Make sure the temperature of the working environment is within the specification.</li> <li>2. Make sure the payload or the project speed is within the specification</li> <li>3. Shut down the robot, and keep it cool for a while before start up again.</li> <li>4. If this issue still occurs, please contact a qualified service engineer for further analysis</li> </ol>
ErrorSuggestion0005F073	<p>[Cause] G sensor overload</p> <p>[Caution]</p> <ol style="list-style-type: none"> <li>1. Check if there robot has collided to the surroundings seriously</li> <li>2. Check the description of this error code to see which joint it belongs to</li> </ol> <p>[Solution]</p>



	<ol style="list-style-type: none"> <li>1. Adjust the payload, safety settings, speed and see if the issue still happens</li> <li>2. Make sure the payload (including the tool) is within the spec.</li> <li>3. Adjust the speed or movement to prevent the risk of having a single joint accelerate too fast</li> <li>4. If it still happens, export the Logs, Project and TCP used, and contact to your service engineer</li> <li>5. Make sure the robot will not collide with the surroundings during project run</li> </ol>
ErrorSuggestion0005F074	<p>[Cause] Hardware Failure</p> <p>[Caution]</p> <p>[Additional Explanation] This error is not likely happens, mostly because of hardware issue</p> <p>[Solution]</p> <ol style="list-style-type: none"> <li>1. Export the Logs</li> <li>2. Contact a qualified service engineer for further analysis</li> </ol>
ErrorSuggestion0005F075	<p>[Cause] Hardware Failure</p> <p>[Caution]</p> <p>[Restriction] Do not drive the joint with or without drive power when this issue happens</p> <p>[Solution]</p> <ol style="list-style-type: none"> <li>1. Export the Logs</li> <li>2. Contact a qualified service engineer for further analysis</li> <li>3. Make sure that the robot does not collide with the surroundings during operation</li> </ol>
ErrorSuggestion0005F0A4	Please contact the original purchase of the manufacturer or a third party designated maintenance unit.
ErrorSuggestion0005F0A5	Please contact the original purchase of the manufacturer or a third party designated maintenance unit.
ErrorSuggestion0005F0A6	Please contact the original purchase of the manufacturer or a third party designated maintenance unit.
ErrorSuggestion0005F111	Please contact the original purchase of the manufacturer or a third party designated maintenance unit.
ErrorSuggestion0005F112	Please contact the original purchase of the manufacturer or a third party designated maintenance unit.
ErrorSuggestion0005F113	Please contact the original purchase of the manufacturer or a third party designated maintenance unit.
ErrorSuggestion0005F114	Please contact the original purchase of the manufacturer or a third party designated maintenance unit.
ErrorSuggestion0005F115	<p>[Cause]Encoder is abnormal</p> <p>[Caution]</p> <p>[Additional Explanation] This error is not likely happens, mostly because of hardware issue</p> <p>[Solution]</p> <ol style="list-style-type: none"> <li>1. Export the log,</li> <li>2. Contact a qualified service engineer for further analysis</li> </ol>
ErrorSuggestion0005F116	<ol style="list-style-type: none"> <li>1. Please try to restart the robot.</li> <li>2. If the restart is invalid, please contact the original purchase or third-party designated maintenance units.</li> </ol>
ErrorSuggestion0005F117	<ol style="list-style-type: none"> <li>1. Please try to restart the robot.</li> <li>2. If the restart is invalid, please contact the original purchase or third-party designated maintenance units.</li> </ol>
ErrorSuggestion0005F118	<ol style="list-style-type: none"> <li>1. Please try to restart the robot.</li> <li>2. If the restart is invalid, please contact the original purchase or third-party designated maintenance units.</li> </ol>
ErrorSuggestion0005F119	<p>[Cause]</p> <ol style="list-style-type: none"> <li>1. Motor is damaged</li> <li>2. Joint PCB is damaged</li> </ol> <p>[Caution]</p> <p>[Additional Explanation] When the resistance of UVW current of motor is abnormal, it will report this error</p> <p>[Solution]</p> <ol style="list-style-type: none"> <li>1. Export the log file</li> <li>2. Contact a qualified service engineer</li> </ol>
ErrorSuggestion0005F11A	<p>[Cause]Hardware Failure</p> <p>[Caution]</p>

	[Additional Explanation] The cables connection of UVW of motor is not correct. Quality issue or the robot may be disassembled abnormally.
	[Solution]
	1. Export the log file
	2. Contact a qualified service engineer
	3. Make sure the robot is not being disassembled illegally
ErrorSuggestion0005F11B	[Cause] Hardware Failure
	[Caution]
	[Restriction] Do not drive the joint with or without drive power when this issue happens
	[Solution]
	1. Export the Logs
	2. Contact a qualified service engineer for further analysis
	3. Make sure that the robot does not collide with the surroundings during operation
ErrorSuggestion0005F11C	1. Please try to restart the robot.
	2. If the restart is invalid, please contact the original purchase or third-party designated maintenance units.
ErrorSuggestion0005F121	Please contact the original purchase of the manufacturer or a third party designated maintenance unit.
ErrorSuggestion0005F122	Please contact the original purchase of the manufacturer or a third party designated maintenance unit.
ErrorSuggestion0005F123	Please contact the original purchase of the manufacturer or a third party designated maintenance unit.
ErrorSuggestion0005F124	Please contact the original purchase of the manufacturer or a third party designated maintenance unit.
ErrorSuggestion0005F125	Please contact the original purchase of the manufacturer or a third party designated maintenance unit.
ErrorSuggestion0005F126	Please contact the original purchase of the manufacturer or a third party designated maintenance unit.
ErrorSuggestion0005F127	Please contact the original purchase of the manufacturer or a third party designated maintenance unit.
ErrorSuggestion0005F128	Please contact the original purchase of the manufacturer or a third party designated maintenance unit.
ErrorSuggestion0005F129	[Cause]Encoder is abnormal
	[Caution]
	[Additional Explanation] This error is not likely happens, mostly because of hardware issue
	[Solution]
	1. Export the log,
	2. Contact a qualified service engineer for further analysis
ErrorSuggestion0005F12A	Please contact the original purchase of the manufacturer or a third party designated maintenance unit.
ErrorSuggestion0005F12B	Please contact the original purchase of the manufacturer or a third party designated maintenance unit.
ErrorSuggestion0005F131	1. Please check grounding line is normal or not.
	2. Please contact the original purchase of the manufacturer or a third party designated maintenance unit.
ErrorSuggestion0005F132	Please contact the original purchase of the manufacturer or a third party designated maintenance unit.
ErrorSuggestion0005F133	[Cause]Robot detect a sudden voltage drop on DCBUS.
	[Caution]
	[Additional Explanation] There may be a variety of reasons that cause a low voltage, for example:
	1. The payload and speed may not in the spec.
	2. Power supply is abnormal
	[Precaution] Power off and unplug the power cable before opening the control box for items checking
	[Solution]
	1. Shut down the robot, make sure the power source is stable then power on.
	2. Make sure the power source is robust for robot running.
	3. Adjust the payload, safety settings, speed and see if the issue still happens
	4. Make sure the payload (including the tool) is within the spec.
	5. Adjust the speed or movement to prevent the risk of having a single joint accelerate too fast
	6. If it still happens, export the Logs, Project and TCP used, and contact to your service engineer

ErrorSuggestion0005F134	<p>[Cause] The communication time of EtherCAT is timeout</p> <p>[Caution] Check if any external EtherCAT device used has lost connection</p> <p>[Additional Explanation] System will periodic check the EtherCAT communication, if communication timeout, it will report this error.</p> <p>[Solution]</p> <p>Contact a qualified service engineer for further analysis</p>
ErrorSuggestion0005F135	<p>[Cause]Joint movement range is over range during brake release process</p> <p>[Caution]Check if the payload is too that out of specification, including the mass, center of mass, inertia, etc.</p> <p>[Additional Explanation] System will detect the movement range while brake release process, when the value is over expected, it will report this error.</p> <p>[Solution]</p> <ol style="list-style-type: none"> <li>1. Power off the robot</li> <li>2. Remove all payload and restart the robot</li> <li>3. Make sure the payload is within specification (including the center of mass and inertia)</li> <li>4. Make sure there is no unexpected force acting on the robot during brake release process</li> <li>5. If this issue still happens, have a qualified service engineer for further analysis</li> </ol>
ErrorSuggestion0005F136	<p>[Cause] Current for solenoid is over specification during brake release process</p> <p>[Additional Explanation] System will detect the current for solenoid during brake releasing process, when it find the value over specification, it will report this error</p> <p>[Solution]</p> <ol style="list-style-type: none"> <li>1. Please press ESTOP button and release it to resume Robot to see the issue is still occurred or not.</li> <li>2. If this still occurs, contact a qualified service engineer for further analysis</li> </ol>
ErrorSuggestion0005F137	<p>[Cause]Robot detect a low voltage on DCBUS.</p> <p>[Caution]</p> <p>[Additional Explanation] There may be a variety of reasons that cause a low voltage, for example:</p> <ol style="list-style-type: none"> <li>1. The power source is not stable on customer-site</li> <li>2. Power supply is abnormal</li> <li>3. etc.</li> </ol> <p>[Precaution] Power off and unplug the power cable before opening the control box for items checking</p> <p>[Solution]</p> <ol style="list-style-type: none"> <li>1. Shut down the robot, make sure the power source is stable then power on.</li> <li>2. Make sure the power source is robust for robot running.</li> <li>3. If the same issue still occurs, contact a qualified service engineer for further analysis</li> </ol>
ErrorSuggestion0005F138	<p>[Cause]Robot detect the voltage on DCBUS is higher than spec.</p> <p>[Caution]Check whether there are others error log along with this error.</p> <p>[Additional Explanation] There may be a variety of reasons that cause a high voltage, for example:</p> <ol style="list-style-type: none"> <li>1. The robot move too fast with the current project (with heavy payload)</li> <li>2. Power eater modules is abnormal</li> <li>3. etc.</li> </ol> <p>[Precaution] Power off and unplug the power cable before opening the control box for items checking</p> <p>[Solution]</p> <ol style="list-style-type: none"> <li>1. Make sure the robot would not be collided and be placed on a unstable platform.</li> <li>2. Make sure project speed with payload is within the specification.</li> <li>3. After restart the robot, the problem still occur, contact a qualified service engineer for further analysis</li> </ol>
ErrorSuggestion0005F139	<p>[Cause]Robot detect a sudden voltage drop on DCBUS.</p> <p>[Caution]</p> <p>[Additional Explanation] There may be a variety of reasons that cause a low voltage, for example:</p>

	<ol style="list-style-type: none"> <li>1. The payload and speed may not in the spec.</li> <li>2. Power supply is abnormal</li> </ol> <p>[Precaution] Power off and unplug the power cable before opening the control box for items checking</p> <p>[Solution]</p> <ol style="list-style-type: none"> <li>1. Shut down the robot, make sure the power source is stable then power on.</li> <li>2. Make sure the power source is robust for robot running.</li> <li>3. Adjust the payload, safety settings, speed and see if the issue still happens</li> <li>4. Make sure the payload (including the tool) is within the spec.</li> <li>5. Adjust the speed or movement to prevent the risk of having a single joint accelerate too fast</li> <li>6. If it still happens, export the Logs, Project and TCP used, and contact to your service engineer</li> </ol>
ErrorSuggestion0005F141	<ol style="list-style-type: none"> <li>1. Please try to restart the robot.</li> <li>2. If the restart is invalid, please contact the original purchase or third-party designated maintenance units.</li> </ol>
ErrorSuggestion0005F142	<ol style="list-style-type: none"> <li>1. Please try to restart the robot.</li> <li>2. If the restart is invalid, please contact the original purchase or third-party designated maintenance units.</li> </ol>
ErrorSuggestion0005F143	<ol style="list-style-type: none"> <li>1. Please try to restart the robot.</li> <li>2. If the restart is invalid, please contact the original purchase or third-party designated maintenance units.</li> </ol>
ErrorSuggestion0005F144	<ol style="list-style-type: none"> <li>1. Please try to restart the robot.</li> <li>2. If the restart is invalid, please contact the original purchase or third-party designated maintenance units.</li> </ol>
ErrorSuggestion0005F145	<p>[Cause] Encoder is dysfunctional</p> <p>[Caution]</p> <p>[Additional Explanation] This error is not likely happens, mostly because of hardware issue</p> <p>[Solution]</p> <ol style="list-style-type: none"> <li>1. Export the Logs</li> <li>2. Contact a qualified service engineer for further analysis</li> </ol>
ErrorSuggestion0005F146	<p>[Cause] Encoder is dysfunctional</p> <p>[Caution]</p> <p>[Additional Explanation] This error is not likely happens, mostly because of hardware issue</p> <p>[Solution]</p> <ol style="list-style-type: none"> <li>1. Export the Logs</li> <li>2. Contact a qualified service engineer for further analysis</li> </ol>
ErrorSuggestion0005F147	<p>[Cause] Encoder is dysfunctional</p> <p>[Caution]</p> <p>[Additional Explanation] This error is not likely happens, mostly because of hardware issue</p> <p>[Solution]</p> <ol style="list-style-type: none"> <li>1. Export the Logs</li> <li>2. Contact a qualified service engineer for further analysis</li> </ol>
ErrorSuggestion0005F148	<p>[Cause] Encoder is dysfunctional</p> <p>[Caution]</p> <p>[Additional Explanation] This error is not likely happens, mostly because of hardware issue</p> <p>[Solution]</p> <ol style="list-style-type: none"> <li>1. Export the Logs</li> <li>2. Contact a qualified service engineer for further analysis</li> </ol>
ErrorSuggestion0005F149	<ol style="list-style-type: none"> <li>1. Please try to restart the robot.</li> <li>2. If the restart is invalid, please contact the original purchase or third-party designated maintenance units.</li> </ol>
ErrorSuggestion0005F1A1	<ol style="list-style-type: none"> <li>1. Please try to restart the robot.</li> <li>2. If the restart is invalid, please contact the original purchase or third-party designated maintenance units.</li> </ol>

ErrorSuggestion0005F1A2	<ol style="list-style-type: none"> <li>1. Please try to restart the robot.</li> <li>2. If the restart is invalid, please contact the original purchase or third-party designated maintenance units.</li> </ol>
ErrorSuggestion0005F1A3	<ol style="list-style-type: none"> <li>1. Please try to restart the robot.</li> <li>2. If the restart is invalid, please contact the original purchase or third-party designated maintenance units.</li> </ol>
ErrorSuggestion0005F1A7	Please contact the original purchase of the manufacturer or a third party designated maintenance unit.
ErrorSuggestion0005FF20	<p>[Cause] Current for solenoid is over specification during brake release process</p> <p>[Additional Explanation] System will detect the current for solenoid during brake releasing process, when it find the value over specification, it will report this error</p> <p>[Solution]</p> <ol style="list-style-type: none"> <li>1. Please press ESTOP button and release it to resume Robot to see the issue is still occurred or not.</li> <li>2. If this still occurs, contact a qualified service engineer for further analysis</li> </ol>
ErrorSuggestion0005FF21	<p>[Cause]Joint movement range is over range during brake release process</p> <p>[Caution]Check if the payload is too that out of specification, including the mass, center of mass, inertia, etc.</p> <p>[Additional Explanation] System will detect the movement range while brake release process, when the value is over expected, it will report this error.</p> <p>[Solution]</p> <ol style="list-style-type: none"> <li>1. Power off the robot</li> <li>2. Remove all payload and restart the robot</li> <li>3. Make sure the payload is within specification (including the center of mass and inertia)</li> <li>4. Make sure there is no unexpected force acting on the robot during brake release process</li> <li>5. If this issue still happens, have a qualified service engineer for further analysis</li> </ol>
ErrorSuggestion0005FFA0	<p>[Cause]Robot detect a low voltage on DCBUS.</p> <p>[Caution]Check if the payload is too that out of specification, including the mass, center of mass, inertia, etc.</p> <p>[Additional Explanation] There may be a variety of reasons that cause a low voltage, for example:</p> <ol style="list-style-type: none"> <li>1. The power source is not stable on customer-site</li> <li>2. Power supply is abnormal</li> <li>3. etc.</li> </ol> <p>[Precaution] Power off and unplug the power cable before opening the control box for items checking</p> <p>[Solution]</p> <p>Shut down the robot, make sure the power source is stable then power on. If the same issue still occurs, contact a qualified service engineer for further analysis</p> <p>Make sure the power source is robust for robot running.</p>
ErrorSuggestion0005FFA1	<p>[Cause]Robot detect the voltage on DCBUS is higher than spec.</p> <p>[Caution]Check whether there are others error log along with this error.</p> <p>[Additional Explanation] There may be a variety of reasons that cause a high voltage, for example:</p> <ol style="list-style-type: none"> <li>1. The robot move too fast with the current project (with heavy payload)</li> <li>2. Power eater modules is abnormal</li> <li>3. etc.</li> </ol> <p>[Precaution] Power off and unplug the power cable before opening the control box for items checking</p> <p>[Solution]</p> <p>After restart the robot, the problem still occur, contact a qualified service engineer for further analysis</p> <ol style="list-style-type: none"> <li>1. Make sure the robot would not be collided and be placed on a unstable platform.</li> <li>2. Make sure project speed with payload is within the specification.</li> </ol>
ErrorSuggestion0005FFA2	Be careful! G sensor overload on X direction.
ErrorSuggestion0005FFA3	Be careful! G sensor overload on Y direction.
ErrorSuggestion0005FFA4	Be careful! G sensor overload on Z direction.

ErrorSuggestion0005FFA5	<p>[Cause]Robot detect the temperature on PCB is higher than spec.</p> <p>[Caution]1. Check if the environment temperature is higher than the spec. while robot moving. 2. Check the temperature on View-&gt;Status</p> <p>[Additional Explanation] The temperature would rise during robot operating and the work space temperature will affect as well.</p> <p>[Solution] Shut down the robot, and keep it cool for a while before start up again. If this issue still occurs, please contact a qualified service engineer for further analysis</p> <ol style="list-style-type: none"> <li>1. Make sure the temperature of the working environment is within the specification.</li> <li>2. Make sure the payload or the project speed is within the specification</li> </ol>
ErrorSuggestion0005FFA6	<p>[Cause]Robot has detected an overshoot of U phase current on the motor</p> <p>[Caution]</p> <ol style="list-style-type: none"> <li>1. Check the header of the error code to see which motor is with this issue</li> <li>2. Check if the robot is run with payload out of spec. and also in high speed</li> <li>3. Check if the safety settings of the robot</li> </ol> <p>[Additional Explanation] If the robot is driven and accelerate fast, current of the motor will overshoot and trigger this error</p> <p>[Additional Explanation] This is usually be triggered when running the robot with a heavy payload with high speed which is nearly or already out of spec.</p> <p>[Additional Explanation] Another reason may be there is dysfunction on the electronics on the motors</p> <p>[Solution]</p> <ol style="list-style-type: none"> <li>1. Shut down and reboot the robot</li> <li>2. Adjust the payload, safety settings, speed and see if the issue still happens</li> <li>3. Make sure the payload (including the tool) is within the spec.</li> <li>4. Adjust the speed or movement to prevent the risk of having a single joint accelerate too fast</li> <li>5. If it still happens, export the Logs, Project and TCP used, and contact to your service engineer</li> </ol>
ErrorSuggestion0005FFA7	<p>[Cause]Robot has detected a overshoot of V phase current on the motor</p> <p>[Caution]</p> <ol style="list-style-type: none"> <li>1. Check the header of the error code to see which motor is with this issue</li> <li>2. Check if the robot is run with payload out of spec. and also in high speed</li> <li>3. Check if the safety settings of the robot</li> </ol> <p>[Additional Explanation] If the robot is driven and accelerate fast, current of the motor will overshoot and trigger this error</p> <p>[Additional Explanation] This is usually be triggered when running the robot with a heavy payload with high speed which is nearly or already out of spec.</p> <p>[Additional Explanation] Another reason may be there is dysfunction on the electronics on the motors</p> <p>[Solution]</p> <ol style="list-style-type: none"> <li>1. Shut down and reboot the robot</li> <li>2. Adjust the payload, safety settings, speed and see if the issue still happens</li> <li>3. Make sure the payload (including the tool) is within the spec.</li> <li>4. Adjust the speed or movement to prevent the risk of having a single joint accelerate too fast</li> <li>5. If it still happens, export the Logs, Project and TCP used, and contact to your service engineer</li> </ol>
ErrorSuggestion0005FFA8	<p>[Cause]Robot has detected a overshoot of W phase current on the motor</p> <p>[Caution]</p> <ol style="list-style-type: none"> <li>1. Check the header of the error code to see which motor is with this issue</li> <li>2. Check if the robot is run with payload out of spec. and also in high speed</li> <li>3. Check if the safety settings of the robot</li> </ol>

ErrorSuggestion0005FFA9  
ErrorSuggestion0005FFAA  
ErrorSuggestion0005FFAB

[Additional Explanation] If the robot is driven and accelerate fast, current of the motor will overshoot and trigger this error

[Additional Explanation] This is usually be triggered when running the robot with a heavy payload with high speed which is nearly or already out of spec.

[Additional Explanation] Another reason may be there is dysfunction on the electronics on the motors

[Solution]

1. Shut down and reboot the robot
2. Adjust the payload, safety settings, speed and see if the issue still happens
3. Make sure the payload (including the tool) is within the spec.
4. Adjust the speed or movement to prevent the risk of having a single joint accelerate too fast
5. If it still happens, export the Logs, Project and TCP used, and contact to your service engineer

Be careful! Motor current protection on U phase triggered, which may be caused by impact.

Be careful! Motor current protection on V phase triggered, which may be caused by impact.

[Cause]The motor current rises sudden and triggers motor hold protection

[Caution]

1. Check if there robot has collided to the surroundings seriously
2. Check the description of this error code to see which joint it belongs to

[Additional Explanation] When the robot collides to a solid object in a high speed, some of the joints may suffer a great torque on them and this causes the motor current raise rapidly and trigger this error

[Precaution] Do not drive the joint manually when this error occurs, which might damage the joint

[Solution]

1. Shut down and reboot the robot
2. Adjust the payload, safety settings, speed and see if the issue still happens
3. Make sure the payload (including the tool) is within the spec.
4. Adjust the speed or movement to prevent the risk of having a single joint accelerate too fast
5. If it still happens, export the Logs, Project and TCP used, and contact to your service engineer
6. Make sure the robot will not collide with the surroundings during project run

ErrorSuggestion0005FFAC  
ErrorSuggestion0005FFAD  
ErrorSuggestion0005FFAE

a error occurred in the UVW signal on optical encoder

The index of encoder is not calibrated.

[Cause]Robot has detected the current on DCBUS went too high suddenly.

[Caution]

1. The speed(ABS/project speed) is too fast.
2. Check whether there is any collision while robot moving.

[Additional Explanations] If robot is moving in a high speed in some movement or pose, it would cause this error. And if robot has collisions, it would cause the current became abnormal.

[Solution][General User]

1. Slow down the speed(ABS/project speed).
2. Avoid any collision while robot is moving.
3. After restart the robot, the problem still occur, contact a qualified service engineer for further analysis.

ErrorSuggestion0005FFAF

[Cause] The communication time of EtherCAT is timeout

[Caution] Check if any external EtherCAT device used has lost connection

[Additional Explanation] System will periodic check the EtherCAT communication, if communication timeout, it will report this error.

[Solution]

Contact a qualified service engineer for further analysis



ErrorSuggestion0005FFB1	[Cause] The communication time of SPI is timeout [Caution] [Additional Explanation] It may possibly because the SPI IC is dysfunction which is not likely to happen [Solution] Contact a qualified service engineer for further analysis
ErrorSuggestion0005FFB2	1. Please check grounding line is normal or not. 2. Please contact the original purchase of the manufacturer or a third party designated maintenance unit.
ErrorSuggestion0005FFB3	Please contact the original purchase of the manufacturer or a third party designated maintenance unit.
ErrorSuggestion0005FFB4	1. Please try to restart the robot. 2. If the restart is invalid, please contact the original purchase or third-party designated maintenance units.
ErrorSuggestion0005FFB5	1. Please try to restart the robot. 2. If the restart is invalid, please contact the original purchase or third-party designated maintenance units.
ErrorSuggestion0005FFB6	Please contact the original purchase of the manufacturer or a third party designated maintenance unit.
ErrorSuggestion0005FFB7	Please check the functionality of break unit
ErrorSuggestion0005FFB8	[Cause] Hardware Failure [Caution] [Additional Explanation] This error is not likely happens, mostly because of hardware issue [Solution] 1. Export the Logs 2. Contact a qualified service engineer for further analysis
ErrorSuggestion0005FFB9	[Cause] Hardware Failure [Caution] [Additional Explanation] This error is not likely happens, mostly because of hardware issue [Solution] 1. Export the Logs 2. Contact a qualified service engineer for further analysis
ErrorSuggestion0005FFBA	[Cause] Hardware Failure [Caution] [Restriction] Do not pull the joint forcibly when the problem occurs, so as not to cause damage to the joint [Solution] 1. Export the Logs 2. Contact a qualified service engineer for further analysis 3. Make sure that the robot does not collide with the surroundings during operation
ErrorSuggestion0005FFC0	a error occurred in transit to absolute position
ErrorSuggestion0005FFC1	Please contact the original purchase of the manufacturer or a third party designated maintenance unit.
ErrorSuggestion0005FFC2	Please contact the original purchase of the manufacturer or a third party designated maintenance unit.
ErrorSuggestion0005FFC3	Please contact the original purchase of the manufacturer or a third party designated maintenance unit.
ErrorSuggestion0005FFC4	Please contact the original purchase of the manufacturer or a third party designated maintenance unit.
ErrorSuggestion0005FFC5	Please contact the original purchase of the manufacturer or a third party designated maintenance unit.
ErrorSuggestion0005FFC6	Please contact the original purchase of the manufacturer or a third party designated maintenance unit.
ErrorSuggestion0005FFC7	Please contact the original purchase of the manufacturer or a third party designated maintenance unit.
ErrorSuggestion0005FFC8	Please contact the original purchase of the manufacturer or a third party designated maintenance unit.
ErrorSuggestion0005FFC9	Please contact the original purchase of the manufacturer or a third party designated maintenance unit.
ErrorSuggestion0005FFCA	[Cause] Encoder is dysfunctional [Caution] [Additional Explanation] This error is not likely happens, mostly because of hardware issue [Solution]



ErrorSuggestion0005FFCB ErrorSuggestion0005FFCC	<p>1. Export the Logs 2. Contact a qualified service engineer for further analysis</p> <p>Please reduce the motion speed, check the flow and the speed and posture in each node</p> <p>[Cause] Encoder is dysfunctional</p> <p>[Caution]</p> <p>[Additional Explanation] This error is not likely happens, mostly because of hardware issue</p> <p>[Solution]</p>
ErrorSuggestion0005FFCD	<p>1. Export the Logs 2. Contact a qualified service engineer for further analysis</p> <p>[Cause] Hardware Failure</p> <p>[Caution]</p> <p>[Restriction] Do not drive the joint with or without drive power when this issue happens</p> <p>[Solution]</p>
ErrorSuggestion0005FFCE	<p>1. Export the Logs 2. Contact a qualified service engineer for further analysis 3. Make sure that the robot does not collide with the surroundings during operation</p> <p>[Cause] Encoder abnormal</p> <p>[Caution]</p> <p>[Restriction] Do not drive the joint with or without drive power</p> <p>[Solution(End User)] Contact a qualified service engineer for further analysis</p> <p>[Solution(Robot Maintenance Staff)] Replace the failed joint.</p>
ErrorSuggestion0005FFCF	<p>[Cause] The motor current rises sudden and triggers motor hold protection</p> <p>[Caution]</p> <p>1. Check if there robot has collided to the surroundings seriously 2. Check the description of this error code to see which joint it belongs to</p> <p>[Additional Explanation] When the robot collides to a solid object in a high speed, some of the joints may suffer a great torque on them and this causes the motor current raise rapidly and trigger this error</p> <p>[Precaution] Do not drive the joint manually when this error occurs, which might damage the joint</p> <p>[Solution]</p> <p>1. Shut down and reboot the robot 2. Adjust the payload, safety settings, speed and see if the issue still happens 3. Make sure the payload (including the tool) is within the spec. 4. Adjust the speed or movement to prevent the risk of having a single joint accelerate too fast 5. If it still happens, export the Logs, Project and TCP used, and contact to your service engineer 6. Make sure the robot will not collide with the surroundings during project run</p>
ErrorSuggestion0005FFD0	Please check the UVW signal on encoder
ErrorSuggestion0005FFD1	<p>[Cause] Hardware Failure</p> <p>[Caution] Check if the robot is placed near any device with strong magnetic field</p> <p>[Additional Explanation] Under a strong magnetic field may affect the readings of the magnetic encoder</p> <p>[Solution]</p> <p>1. Export the Logs 2. Make sure the robot is not under any strong magnetic field and then reboot the robot 3. If this still does not work, Contact a qualified service engineer for further analysis</p>

ErrorSuggestion0005FFD2	<p>[Cause] Hardware Failure</p> <p>[Caution] Check if the robot is placed near any device with strong magnetic field</p> <p>[Additional Explanation] Under a strong magnetic field may affect the readings of the magnetic encoder</p> <p>[Solution]</p> <ol style="list-style-type: none"> <li>1. Export the Logs</li> <li>2. Make sure the robot is not under any strong magnetic field and then reboot the robot</li> <li>3. If this still does not work, Contact a qualified service engineer for further analysis</li> </ol>
ErrorSuggestion0005FFD3	<p>[Cause]</p> <ol style="list-style-type: none"> <li>1. The robot may be disassembled abnormally. Please check the warranty sticker and thread-locking fluid are both broken or not</li> <li>2. Joint gear wear out</li> </ol> <p>[Caution]</p> <p>[Additional Explanation] When the origin of joint module is not detected, it will report this error</p> <p>[Solution]</p> <ol style="list-style-type: none"> <li>1. Export the Logs</li> <li>2. Contact a qualified service engineer for further analysis</li> </ol>
ErrorSuggestion0005FFD4	Please contact the original purchase of the manufacturer or a third party designated maintenance unit.
ErrorSuggestion0005FFD5	Please contact the original purchase of the manufacturer or a third party designated maintenance unit.
ErrorSuggestion0005FFD6	Please contact the original purchase of the manufacturer or a third party designated maintenance unit.
ErrorSuggestion0005FFD7	Please contact the original purchase of the manufacturer or a third party designated maintenance unit.
ErrorSuggestion0005FFD8	<p>[Cause]</p> <ol style="list-style-type: none"> <li>1. Motor is damaged</li> <li>2. Joint PCB is damaged</li> </ol> <p>[Additional Explanation] When the resistance of UVW current of motor is abnormal, it will report this error</p> <p>[Solution]</p> <ol style="list-style-type: none"> <li>1. Export the log file</li> <li>2. Contact a qualified service engineer</li> </ol>
ErrorSuggestion0005FFD9	<p>[Cause] Hardware Failure</p> <p>[Additional Explanation] The cables connection of UVW of motor is not correct. Quality issue or the robot may be disassembled abnormally.</p> <p>[Solution]</p> <ol style="list-style-type: none"> <li>1. Export the log file</li> <li>2. Contact a qualified service engineer</li> <li>3. Make sure the robot is not being disassembled illegally</li> </ol>
ErrorSuggestion0005FFDA	Please contact the original purchase of the manufacturer or a third party designated maintenance unit.
ErrorSuggestion0005FFDB	Please contact the original purchase of the manufacturer or a third party designated maintenance unit.
ErrorSuggestion0005FFDC	Please contact the original purchase of the manufacturer or a third party designated maintenance unit.
ErrorSuggestion0005FFDD	<ol style="list-style-type: none"> <li>1. Please restart the robot.</li> <li>2. If the restart is invalid, please contact the original purchase or third-party designated maintenance units.</li> </ol>
ErrorSuggestion0005FFDE	<ol style="list-style-type: none"> <li>1. Please restart the robot.</li> <li>2. If the restart is invalid, please contact the original purchase or third-party designated maintenance units.</li> </ol>
ErrorSuggestion0005FFDF	<ol style="list-style-type: none"> <li>1. Please restart the robot.</li> <li>2. If the restart is invalid, please contact the original purchase or third-party designated maintenance units.</li> </ol>
ErrorSuggestion0005FFE0	<p>[Cause]</p> <ol style="list-style-type: none"> <li>1. Power supply is not stable.</li> <li>2. Robot moves in high speed, current is higher, voltage loss getting higher. (<math>V_{input} - V_{loss} = V</math> for DC bus)</li> <li>3. Power connector problem, consume too much power</li> </ol>

	[Additional Explanation] When robot is working and detects the voltage of DC bus is low, it will report this error
	[Solution]
	1. Power off the robot
	2. Check Robot Cable and its connector before power on again
	3. Reduce Robot speed if necessary
	Make sure power source is stable
ErrorSuggestion0005FFE1	Please contact the original purchase of the manufacturer or a third party designated maintenance unit.
ErrorSuggestion0005FFE2	1. Please restart the robot.
	2. If the restart is invalid, please contact the original purchase or third-party designated maintenance units.
ErrorSuggestion0005FFE3	1. Please restart the robot.
	2. If the restart is invalid, please contact the original purchase or third-party designated maintenance units.
ErrorSuggestion0005FFE4	[Cause] Encoder is abnormal
	[Additional Explanation] This error is not likely happens, mostly because of hardware issue
	[Solution]
	1. Export the log file
	2. Contact a qualified service engineer
ErrorSuggestion0005FFE5	1. Please restart the robot.
	2. If the restart is invalid, please contact the original purchase or third-party designated maintenance units.
ErrorSuggestion0005FFE6	1. Please restart the robot.
	2. If the restart is invalid, please contact the original purchase or third-party designated maintenance units.
ErrorSuggestion0005FFE7	Please contact the original purchase of the manufacturer or a third party designated maintenance unit.
ErrorSuggestion0005FFE8	[Cause]Hardware Failure
	[Additional Explanation] When the output of the G sensor is abnormal, it will report this error
	[Solution]
	1. Export the log file
	2. Contact a qualified service engineer
ErrorSuggestion0005FFE9	Please contact the original purchase of the manufacturer or a third party designated maintenance unit.
ErrorSuggestion0005FFEA	[Cause] DC to DC component on Join PCB is damaged
	[Additional Explanation] When detect voltage of 5V is abnormal, it will report this error
	[Solution]
	1. Export the log file
	2. Contact a qualified service engineer
ErrorSuggestion0005FFEB	[Cause] DC to DC component on Join PCB is damaged
	[Additional Explanation] When detect voltage of 12V is abnormal, it will report this error
	[Solution]
	1. Export the log file
	2. Contact a qualified service engineer
ErrorSuggestion0005FFEC	Please contact the original purchase of the manufacturer or a third party designated maintenance unit.
ErrorSuggestion0005FFED	[Cause] Encoder abnormal
	[Caution]
	[Restriction] Do not drive the joint with or without drive power
	[Solution(End User)]
	Contact a qualified service engineer for further analysis
	[Solution(Robot Maintenance Staff)]
	Replace the failed joint.
ErrorSuggestion0005FFEE	Please turn on joint modules
ErrorSuggestion0005FFEF	Please contact the original purchase of the manufacturer or a third party designated maintenance unit.















ErrorSuggestion00070106	[Hardware Failure] 1. Please try to restart the robot. 2. If the restart is invalid, please contact the original purchase or third-party designated maintenance units.
ErrorSuggestion00070107	[Hardware Failure] 1. Please try to restart the robot. 2. If the restart is invalid, please contact the original purchase or third-party designated maintenance units.
ErrorSuggestion00070108	[Hardware Failure] 1. Please try to restart the robot. 2. If the restart is invalid, please contact the original purchase or third-party designated maintenance units.
ErrorSuggestion00070109	[Hardware Failure] 1. Please try to restart the robot. 2. If the restart is invalid, please contact the original purchase or third-party designated maintenance units.
ErrorSuggestion0007010A	[Hardware Failure] 1. Please try to restart the robot. 2. If the restart is invalid, please contact the original purchase or third-party designated maintenance units.
ErrorSuggestion0007010B	[Hardware Failure] 1. Please try to restart the robot. 2. If the restart is invalid, please contact the original purchase or third-party designated maintenance units.
ErrorSuggestion00070110	[Hardware Failure] 1. Please try to restart the robot. 2. If the restart is invalid, please contact the original purchase or third-party designated maintenance units.
ErrorSuggestion00070111	[Hardware Failure] 1. Please try to restart the robot. 2. If the restart is invalid, please contact the original purchase or third-party designated maintenance units.
ErrorSuggestion00070112	[Hardware Failure] 1. Please try to restart the robot. 2. If the restart is invalid, please contact the original purchase or third-party designated maintenance units.
ErrorSuggestion00070113	[Hardware Failure] 1. Please try to restart the robot. 2. If the restart is invalid, please contact the original purchase or third-party designated maintenance units.
ErrorSuggestion00070114	[Hardware Failure] 1. Please try to restart the robot. 2. If the restart is invalid, please contact the original purchase or third-party designated maintenance units.
ErrorSuggestion00070115	[Hardware Failure] 1. Please try to restart the robot. 2. If the restart is invalid, please contact the original purchase or third-party designated maintenance units.
ErrorSuggestion00070116	[Hardware Failure] 1. Please try to restart the robot. 2. If the restart is invalid, please contact the original purchase or third-party designated maintenance units.
ErrorSuggestion00070121	[Hardware Failure] 1. Please try to restart the robot. 2. If the restart is invalid, please contact the original purchase or third-party designated maintenance units.
ErrorSuggestion00070122	[Hardware Failure] 1. Please try to restart the robot. 2. If the restart is invalid, please contact the original purchase or third-party designated maintenance units.

ErrorSuggestion00070123	[Hardware Failure] 1. Please try to restart the robot. 2. If the restart is invalid, please contact the original purchase or third-party designated maintenance units.
ErrorSuggestion00070124	[Hardware Failure] 1. Please try to restart the robot. 2. If the restart is invalid, please contact the original purchase or third-party designated maintenance units.
ErrorSuggestion00070125	[Hardware Failure] 1. Please try to restart the robot. 2. If the restart is invalid, please contact the original purchase or third-party designated maintenance units.
ErrorSuggestion00070126	[Hardware Failure] 1. Please try to restart the robot. 2. If the restart is invalid, please contact the original purchase or third-party designated maintenance units.
ErrorSuggestion00070131	[Hardware Failure] 1. Please try to restart the robot. 2. If the restart is invalid, please contact the original purchase or third-party designated maintenance units.
ErrorSuggestion00070132	[Hardware Failure] 1. Please try to restart the robot. 2. If the restart is invalid, please contact the original purchase or third-party designated maintenance units.
ErrorSuggestion00070133	[Hardware Failure] 1. Please try to restart the robot. 2. If the restart is invalid, please contact the original purchase or third-party designated maintenance units.
ErrorSuggestion00070134	[Hardware Failure] 1. Please try to restart the robot. 2. If the restart is invalid, please contact the original purchase or third-party designated maintenance units.
ErrorSuggestion00070135	[Hardware Failure] 1. Please try to restart the robot. 2. If the restart is invalid, please contact the original purchase or third-party designated maintenance units.
ErrorSuggestion00070136	[Hardware Failure] 1. Please try to restart the robot. 2. If the restart is invalid, please contact the original purchase or third-party designated maintenance units.
ErrorSuggestion00070141	[Hardware Failure] 1. Please try to restart the robot. 2. If the restart is invalid, please contact the original purchase or third-party designated maintenance units.
ErrorSuggestion00070142	[Hardware Failure] 1. Please try to restart the robot. 2. If the restart is invalid, please contact the original purchase or third-party designated maintenance units.
ErrorSuggestion00070143	[Hardware Failure] 1. Please try to restart the robot. 2. If the restart is invalid, please contact the original purchase or third-party designated maintenance units.
ErrorSuggestion00070144	[Hardware Failure] 1. Please try to restart the robot. 2. If the restart is invalid, please contact the original purchase or third-party designated maintenance units.
ErrorSuggestion00070145	[Hardware Failure] 1. Please try to restart the robot. 2. If the restart is invalid, please contact the original purchase or third-party designated maintenance units.

ErrorSuggestion00070146	[Hardware Failure] 1. Please try to restart the robot. 2. If the restart is invalid, please contact the original purchase or third-party designated maintenance units.
ErrorSuggestion00070151	[Cause] 1. TMsafe slave address mismatch [Solution] 1. Please contact the original purchase or third-party designated maintenance units.
ErrorSuggestion00070152	[Cause] 1. TMsafe slave address mismatch [Solution] 1. Please contact the original purchase or third-party designated maintenance units.
ErrorSuggestion00070153	[Cause] 1. TMsafe slave address mismatch [Solution] 1. Please contact the original purchase or third-party designated maintenance units.
ErrorSuggestion00070154	[Cause] 1. TMsafe slave address mismatch [Solution] 1. Please contact the original purchase or third-party designated maintenance units.
ErrorSuggestion00070155	[Cause] 1. TMsafe slave address mismatch [Solution] 1. Please contact the original purchase or third-party designated maintenance units.
ErrorSuggestion00070156	[Cause] 1. TMsafe slave address mismatch [Solution] 1. Please contact the original purchase or third-party designated maintenance units.
ErrorSuggestion00070161	[Hardware Failure] 1. Please try to restart the robot. 2. If the restart is invalid, please contact the original purchase or third-party designated maintenance units.
ErrorSuggestion00070162	[Hardware Failure] 1. Please try to restart the robot. 2. If the restart is invalid, please contact the original purchase or third-party designated maintenance units.
ErrorSuggestion00070163	[Hardware Failure] 1. Please try to restart the robot. 2. If the restart is invalid, please contact the original purchase or third-party designated maintenance units.
ErrorSuggestion00070164	[Hardware Failure] 1. Please try to restart the robot. 2. If the restart is invalid, please contact the original purchase or third-party designated maintenance units.
ErrorSuggestion00070165	[Hardware Failure] 1. Please try to restart the robot. 2. If the restart is invalid, please contact the original purchase or third-party designated maintenance units.
ErrorSuggestion00070166	[Hardware Failure] 1. Please try to restart the robot. 2. If the restart is invalid, please contact the original purchase or third-party designated maintenance units.

ErrorSuggestion00070171	[Hardware Failure] 1. Please try to restart the robot. 2. If the restart is invalid, please contact the original purchase or third-party designated maintenance units.
ErrorSuggestion00070172	[Hardware Failure] 1. Please try to restart the robot. 2. If the restart is invalid, please contact the original purchase or third-party designated maintenance units.
ErrorSuggestion00070173	[Hardware Failure] 1. Please try to restart the robot. 2. If the restart is invalid, please contact the original purchase or third-party designated maintenance units.
ErrorSuggestion00070174	[Hardware Failure] 1. Please try to restart the robot. 2. If the restart is invalid, please contact the original purchase or third-party designated maintenance units.
ErrorSuggestion00070175	[Hardware Failure] 1. Please try to restart the robot. 2. If the restart is invalid, please contact the original purchase or third-party designated maintenance units.
ErrorSuggestion00070176	[Hardware Failure] 1. Please try to restart the robot. 2. If the restart is invalid, please contact the original purchase or third-party designated maintenance units.
ErrorSuggestion00070181	[Hardware Failure] 1. Please try to restart the robot. 2. If the restart is invalid, please contact the original purchase or third-party designated maintenance units.
ErrorSuggestion00070182	[Hardware Failure] 1. Please try to restart the robot. 2. If the restart is invalid, please contact the original purchase or third-party designated maintenance units.
ErrorSuggestion00070183	[Hardware Failure] 1. Please try to restart the robot. 2. If the restart is invalid, please contact the original purchase or third-party designated maintenance units.
ErrorSuggestion00070184	[Hardware Failure] 1. Please try to restart the robot. 2. If the restart is invalid, please contact the original purchase or third-party designated maintenance units.
ErrorSuggestion00070185	[Hardware Failure] 1. Please try to restart the robot. 2. If the restart is invalid, please contact the original purchase or third-party designated maintenance units.
ErrorSuggestion00070186	[Hardware Failure] 1. Please try to restart the robot. 2. If the restart is invalid, please contact the original purchase or third-party designated maintenance units.
ErrorSuggestion00070191	[Hardware Failure] 1. Please try to restart the robot. 2. If the restart is invalid, please contact the original purchase or third-party designated maintenance units.
ErrorSuggestion00070192	[Hardware Failure] 1. Please try to restart the robot. 2. If the restart is invalid, please contact the original purchase or third-party designated maintenance units.
ErrorSuggestion00070193	[Hardware Failure] 1. Please try to restart the robot. 2. If the restart is invalid, please contact the original purchase or third-party designated maintenance units.

ErrorSuggestion00070194	[Hardware Failure] 1. Please try to restart the robot. 2. If the restart is invalid, please contact the original purchase or third-party designated maintenance units.
ErrorSuggestion00070195	[Hardware Failure] 1. Please try to restart the robot. 2. If the restart is invalid, please contact the original purchase or third-party designated maintenance units.
ErrorSuggestion00070196	[Hardware Failure] 1. Please try to restart the robot. 2. If the restart is invalid, please contact the original purchase or third-party designated maintenance units.
ErrorSuggestion000701A1	[Hardware Failure] 1. Please try to restart the robot. 2. If the restart is invalid, please contact the original purchase or third-party designated maintenance units.
ErrorSuggestion000701A2	[Hardware Failure] 1. Please try to restart the robot. 2. If the restart is invalid, please contact the original purchase or third-party designated maintenance units.
ErrorSuggestion000701A3	[Hardware Failure] 1. Please try to restart the robot. 2. If the restart is invalid, please contact the original purchase or third-party designated maintenance units.
ErrorSuggestion000701A4	[Hardware Failure] 1. Please try to restart the robot. 2. If the restart is invalid, please contact the original purchase or third-party designated maintenance units.
ErrorSuggestion000701A5	[Hardware Failure] 1. Please try to restart the robot. 2. If the restart is invalid, please contact the original purchase or third-party designated maintenance units.
ErrorSuggestion000701A6	[Hardware Failure] 1. Please try to restart the robot. 2. If the restart is invalid, please contact the original purchase or third-party designated maintenance units.
ErrorSuggestion000701B1	[Hardware Failure] 1. Please try to restart the robot. 2. If the restart is invalid, please contact the original purchase or third-party designated maintenance units.
ErrorSuggestion000701B2	[Hardware Failure] 1. Please try to restart the robot. 2. If the restart is invalid, please contact the original purchase or third-party designated maintenance units.
ErrorSuggestion000701B3	[Hardware Failure] 1. Please try to restart the robot. 2. If the restart is invalid, please contact the original purchase or third-party designated maintenance units.
ErrorSuggestion000701B4	[Hardware Failure] 1. Please try to restart the robot. 2. If the restart is invalid, please contact the original purchase or third-party designated maintenance units.
ErrorSuggestion000701B5	[Hardware Failure] 1. Please try to restart the robot. 2. If the restart is invalid, please contact the original purchase or third-party designated maintenance units.
ErrorSuggestion000701B6	[Hardware Failure] 1. Please try to restart the robot. 2. If the restart is invalid, please contact the original purchase or third-party designated maintenance units.
ErrorSuggestion000701F1	[Cause] 1. TMsafe slave address mismatch

ErrorSuggestion000701F2	<p>[Solution]</p> <p>1. Please contact the original purchase or third-party designated maintenance units.</p> <p>[Cause]</p> <p>1. TMsafe slave address mismatch</p> <p>[Solution]</p> <p>1. Please contact the original purchase or third-party designated maintenance units.</p>
ErrorSuggestion000701F3	<p>[Cause]</p> <p>1. TMsafe slave address mismatch</p> <p>[Solution]</p> <p>1. Please contact the original purchase or third-party designated maintenance units.</p>
ErrorSuggestion000701F4	<p>[Cause]</p> <p>1. TMsafe slave address mismatch</p> <p>[Solution]</p> <p>1. Please contact the original purchase or third-party designated maintenance units.</p>
ErrorSuggestion000701F5	<p>[Cause]</p> <p>1. TMsafe slave address mismatch</p> <p>[Solution]</p> <p>1. Please contact the original purchase or third-party designated maintenance units.</p>
ErrorSuggestion000701F6	<p>[Cause]</p> <p>1. TMsafe slave address mismatch</p> <p>[Solution]</p> <p>1. Please contact the original purchase or third-party designated maintenance units.</p>
ErrorSuggestion00070200	<p>[Cause]</p> <p>1. The external safety device input discrepancy.</p> <p>[Caution]</p> <p>1. Check if the wire on the external safety device port(s) is securely fastened.</p> <p>[Precaution]</p> <p>When the situation above is triggered, the robot will enter STO, which means the power is cut off after the robot speed has been decreased to zero. If there are any payloads on the TCP, without drive power, the TCP will tend to drop a little bit before coming to a complete stop. Please be aware of the tool (payload) colliding with objects in close proximity.</p> <p>1. Ensure that all wires connected to the external safety device port(s) are securely connected.</p>
ErrorSuggestion00070201	<p>[Solution]</p> <p>1. If discrepancy happens in external safety device input:</p> <ol style="list-style-type: none"> <li>a. Check and fix the wire connection on control box.</li> <li>b. Trigger the corresponded safety IO port for more than one seconds and than untrigger.</li> <li>c. Trigger Robot Stick Reset button or user connected Reset input to power on the robot.</li> <li>d. If under Manual Mode, it requires the trigger of Enabling Switch function to release the brake of the robot.</li> </ol> <p>[Cause]</p> <p>1. The external safety device input discrepancy.</p> <p>[Caution]</p> <p>1. Check if the wire on the external safety device port(s) is securely fastened.</p> <p>[Precaution]</p> <p>When the situation above is triggered, the robot will enter STO, which means the power is cut off after the robot speed has been decreased to zero. If there are any payloads on the TCP, without drive power, the TCP will tend to drop a little bit before coming to a complete stop. Please be aware of the tool (payload) colliding with objects in close proximity.</p>

1. Ensure that all wires connected to the external safety device port(s) are securely connected.

[Solution]

1. If discrepancy happens in external safety device input:
  - a. Check and fix the wire connection on control box.
  - b. Trigger the corresponded safety IO port for more than one seconds and than untrigger.
  - c. Trigger Robot Stick Reset button or user connected Reset input to power on the robot.
  - d. If under Manual Mode, it requires the trigger of Enabling Switch function to release the brake of the robot.

ErrorSuggestion00070202

[Cause]

1. The external safety device input discrepancy.

[Caution]

1. Check if the wire on the external safety device port(s) is securely fastened.

[Precaution]

When the situation above is triggered, the robot will enter STO, which means the power is cut off after the robot speed has been decreased to zero. If there are any payloads on the TCP, without drive power, the TCP will tend to drop a little bit before coming to a complete stop. Please be aware of the tool (payload) colliding with objects in close proximity.

1. Ensure that all wires connected to the external safety device port(s) are securely connected.

[Solution]

1. If discrepancy happens in external safety device input:
  - a. Check and fix the wire connection on control box.
  - b. Trigger the corresponded safety IO port for more than one seconds and than untrigger.
  - c. Trigger Robot Stick Reset button or user connected Reset input to power on the robot.
  - d. If under Manual Mode, it requires the trigger of Enabling Switch function to release the brake of the robot.

ErrorSuggestion00070203

[Cause]

1. The external safety device input discrepancy.

[Caution]

1. Check if the wire on the external safety device port(s) is securely fastened.

[Precaution]

When the situation above is triggered, the robot will enter STO, which means the power is cut off after the robot speed has been decreased to zero. If there are any payloads on the TCP, without drive power, the TCP will tend to drop a little bit before coming to a complete stop. Please be aware of the tool (payload) colliding with objects in close proximity.

1. Ensure that all wires connected to the external safety device port(s) are securely connected.

[Solution]

1. If discrepancy happens in external safety device input:
  - a. Check and fix the wire connection on control box.
  - b. Trigger the corresponded safety IO port for more than one seconds and than untrigger.
  - c. Trigger Robot Stick Reset button or user connected Reset input to power on the robot.
  - d. If under Manual Mode, it requires the trigger of Enabling Switch function to release the brake of the robot.

ErrorSuggestion00070204

[Cause]

1. The external safety device input discrepancy.

[Caution]

1. Check if the wire on the external safety device port(s) is securely fastened.

[Precaution]

When the situation above is triggered, the robot will enter STO, which means the power is cut off after the robot speed has been decreased to zero. If there are any payloads on the TCP, without drive power, the TCP will tend to drop a little bit before coming to a complete stop. Please be aware of the tool (payload) colliding with objects in close

proximity.

1. Ensure that all wires connected to the external safety device port(s) are securely connected.

[Solution]

1. If discrepancy happens in external safety device input:
  - a. Check and fix the wire connection on control box.
  - b. Trigger the corresponded safety IO port for more than one seconds and than untrigger.
  - c. Trigger Robot Stick Reset button or user connected Reset input to power on the robot.
  - d. If under Manual Mode, it requires the trigger of Enabling Switch function to release the brake of the robot.

ErrorSuggestion00070205

[Cause]

1. The external safety device input discrepancy.

[Caution]

1. Check if the wire on the external safety device port(s) is securely fastened.

[Precaution]

When the situation above is triggered, the robot will enter STO, which means the power is cut off after the robot speed has been decreased to zero. If there are any payloads on the TCP, without drive power, the TCP will tend to drop a little bit before coming to a complete stop. Please be aware of the tool (payload) colliding with objects in close proximity.

1. Ensure that all wires connected to the external safety device port(s) are securely connected.

[Solution]

1. If discrepancy happens in external safety device input:
  - a. Check and fix the wire connection on control box.
  - b. Trigger the corresponded safety IO port for more than one seconds and than untrigger.
  - c. Trigger Robot Stick Reset button or user connected Reset input to power on the robot.
  - d. If under Manual Mode, it requires the trigger of Enabling Switch function to release the brake of the robot.

ErrorSuggestion00070206

[Cause]

1. The external safety device input discrepancy.

[Caution]

1. Check if the wire on the external safety device port(s) is securely fastened.

[Precaution]

When the situation above is triggered, the robot will enter STO, which means the power is cut off after the robot speed has been decreased to zero. If there are any payloads on the TCP, without drive power, the TCP will tend to drop a little bit before coming to a complete stop. Please be aware of the tool (payload) colliding with objects in close proximity.

1. Ensure that all wires connected to the external safety device port(s) are securely connected.

[Solution]

1. If discrepancy happens in external safety device input:
  - a. Check and fix the wire connection on control box.
  - b. Trigger the corresponded safety IO port for more than one seconds and than untrigger.
  - c. Trigger Robot Stick Reset button or user connected Reset input to power on the robot.
  - d. If under Manual Mode, it requires the trigger of Enabling Switch function to release the brake of the robot.

ErrorSuggestion00070207

[Cause]

1. The external safety device input discrepancy.

[Caution]

1. Check if the wire on the external safety device port(s) is securely fastened.

[Precaution]

When the situation above is triggered, the robot will enter STO, which means the power is cut off after the robot speed has been decreased to zero. If there are any payloads on the TCP, without drive power, the TCP will tend to drop a



little bit before coming to a complete stop. Please be aware of the tool (payload) colliding with objects in close proximity.

1. Ensure that all wires connected to the external safety device port(s) are securely connected.

[Solution]

1. If discrepancy happens in external safety device input:
  - a. Check and fix the wire connection on control box.
  - b. Trigger the corresponded safety IO port for more than one seconds and than untrigger.
  - c. Trigger Robot Stick Reset button or user connected Reset input to power on the robot.
  - d. If under Manual Mode, it requires the trigger of Enabling Switch function to release the brake of the robot.

ErrorSuggestion00070208

[Hardware Failure]

1. Please try to restart the robot.
2. If the restart is invalid, please contact the original purchase or third-party designated maintenance units.

ErrorSuggestion00070209

[Hardware Failure]

1. Please try to restart the robot.
2. If the restart is invalid, please contact the original purchase or third-party designated maintenance units.

ErrorSuggestion00070210

[Hardware Failure]

1. Please try to restart the robot.
2. If the restart is invalid, please contact the original purchase or third-party designated maintenance units.

ErrorSuggestion00070300

[Hardware Failure]

1. Please try to restart the robot.
2. If the restart is invalid, please contact the original purchase or third-party designated maintenance units.

ErrorSuggestion00070301

[Hardware Failure]

1. Please try to restart the robot.
2. If the restart is invalid, please contact the original purchase or third-party designated maintenance units.

ErrorSuggestion00070302

[Hardware Failure]

1. Please try to restart the robot.
2. If the restart is invalid, please contact the original purchase or third-party designated maintenance units.

ErrorSuggestion00070303

[Hardware Failure]

1. Please try to restart the robot.
2. If the restart is invalid, please contact the original purchase or third-party designated maintenance units.

ErrorSuggestion00070304

[Hardware Failure]

1. Please try to restart the robot.
2. If the restart is invalid, please contact the original purchase or third-party designated maintenance units.

ErrorSuggestion00070305

[Hardware Failure]

1. Please try to restart the robot.
2. If the restart is invalid, please contact the original purchase or third-party designated maintenance units.

ErrorSuggestion00070306

[Hardware Failure]

1. Please try to restart the robot.
2. If the restart is invalid, please contact the original purchase or third-party designated maintenance units.

ErrorSuggestion00070307

[Hardware Failure]

1. Please try to restart the robot.
2. If the restart is invalid, please contact the original purchase or third-party designated maintenance units.

ErrorSuggestion00070400

[Hardware Failure]

1. Please try to restart the robot.
2. If the restart is invalid, please contact the original purchase or third-party designated maintenance units.

ErrorSuggestion00070500	[Hardware Failure] 1. Please try to restart the robot. 2. If the restart is invalid, please contact the original purchase or third-party designated maintenance units.
ErrorSuggestion00070600	[Hardware Failure] 1. Please try to restart the robot. 2. If the restart is invalid, please contact the original purchase or third-party designated maintenance units.
ErrorSuggestion00070601	[Hardware Failure] 1. Please try to restart the robot. 2. If the restart is invalid, please contact the original purchase or third-party designated maintenance units.
ErrorSuggestion00070602	[Hardware Failure] 1. Please try to restart the robot. 2. If the restart is invalid, please contact the original purchase or third-party designated maintenance units.
ErrorSuggestion00070603	[Hardware Failure] 1. Please try to restart the robot. 2. If the restart is invalid, please contact the original purchase or third-party designated maintenance units.
ErrorSuggestion00070604	[Hardware Failure] 1. Please try to restart the robot. 2. If the restart is invalid, please contact the original purchase or third-party designated maintenance units.
ErrorSuggestion00070605	[Hardware Failure] 1. Please try to restart the robot. 2. If the restart is invalid, please contact the original purchase or third-party designated maintenance units.
ErrorSuggestion00070606	[Hardware Failure] 1. Please try to restart the robot. 2. If the restart is invalid, please contact the original purchase or third-party designated maintenance units.
ErrorSuggestion00070607	[Hardware Failure] 1. Please try to restart the robot. 2. If the restart is invalid, please contact the original purchase or third-party designated maintenance units.
ErrorSuggestion00070608	[Hardware Failure] 1. Please try to restart the robot. 2. If the restart is invalid, please contact the original purchase or third-party designated maintenance units.
ErrorSuggestion00070609	[Hardware Failure] 1. Please try to restart the robot. 2. If the restart is invalid, please contact the original purchase or third-party designated maintenance units.
ErrorSuggestion0007060A	[Hardware Failure] 1. Please try to restart the robot. 2. If the restart is invalid, please contact the original purchase or third-party designated maintenance units.
ErrorSuggestion0007060B	[Hardware Failure] 1. Please try to restart the robot. 2. If the restart is invalid, please contact the original purchase or third-party designated maintenance units.
ErrorSuggestion0007060C	[Hardware Failure] 1. Please try to restart the robot. 2. If the restart is invalid, please contact the original purchase or third-party designated maintenance units.
ErrorSuggestion0007060D	[Hardware Failure] 1. Please try to restart the robot. 2. If the restart is invalid, please contact the original purchase or third-party designated maintenance units.

ErrorSuggestion00070700	[Hardware Failure] 1. Please try to restart the robot. 2. If the restart is invalid, please contact the original purchase or third-party designated maintenance units.
ErrorSuggestion00070701	[Hardware Failure] 1. Please try to restart the robot. 2. If the restart is invalid, please contact the original purchase or third-party designated maintenance units.
ErrorSuggestion00070702	[Hardware Failure] 1. Please try to restart the robot. 2. If the restart is invalid, please contact the original purchase or third-party designated maintenance units.
ErrorSuggestion00070703	[Hardware Failure] 1. Please try to restart the robot. 2. If the restart is invalid, please contact the original purchase or third-party designated maintenance units.
ErrorSuggestion00070704	[Hardware Failure] 1. Please try to restart the robot. 2. If the restart is invalid, please contact the original purchase or third-party designated maintenance units.
ErrorSuggestion00070705	[Hardware Failure] 1. Please try to restart the robot. 2. If the restart is invalid, please contact the original purchase or third-party designated maintenance units.
ErrorSuggestion00070800	[Hardware Failure] 1. Please try to restart the robot. 2. If the restart is invalid, please contact the original purchase or third-party designated maintenance units.
ErrorSuggestion00070801	[Hardware Failure] 1. Please try to restart the robot. 2. If the restart is invalid, please contact the original purchase or third-party designated maintenance units.
ErrorSuggestion00070900	[Hardware Failure] 1. Please try to restart the robot. 2. If the restart is invalid, please contact the original purchase or third-party designated maintenance units.
ErrorSuggestion00070A00	[Hardware Failure] 1. Please try to restart the robot. 2. If the restart is invalid, please contact the original purchase or third-party designated maintenance units.
ErrorSuggestion00070A01	[Hardware Failure] 1. Please try to restart the robot. 2. If the restart is invalid, please contact the original purchase or third-party designated maintenance units.
ErrorSuggestion00070A02	[Hardware Failure] 1. Please try to restart the robot. 2. If the restart is invalid, please contact the original purchase or third-party designated maintenance units.
ErrorSuggestion00070B00	[Hardware Failure] 1. Please try to restart the robot. 2. If the restart is invalid, please contact the original purchase or third-party designated maintenance units.
ErrorSuggestion00150000	No Error
ErrorSuggestion0015F051	[Cause]Robot has detected an overshoot of U phase current on the motor [Caution] 1. Check the header of the error code to see which motor is with this issue 2. Check if the robot is run with payload out of spec and also in high speed 3. Check if the safety settings of the robot [Additional Explanation] If the robot is driven and accelerate fast, current of the motor will overshoot and trigger this error

ErrorSuggestion0015F052

[Additional Explanation] This is usually be triggered when running the robot with a heavy payload with high speed which is nearly or already out of spec.

[Additional Explanation] Another reason may be there is dysfunction on the electronics on the motors

[Solution]

1. Shut down and reboot the robot
2. Make sure the payload (including the tool) is within the spec.
3. Adjust the speed or movement to prevent the risk of having a single joint accelerate too fast
4. If it still happens, export the Logs, Project and TCP used, and contact to your service engineer

[Cause]Robot has detected a overshoot of V phase current on the motor

[Caution]

1. Check the header of the error code to see which motor is with this issue
2. Check if the robot is run with payload out of spec. and also in high speed
3. Check if the safety settings of the robot

[Additional Explanation] If the robot is driven and accelerate fast, current of the motor will overshoot and trigger this error

[Additional Explanation] This is usually be triggered when running the robot with a heavy payload with high speed which is nearly or already out of spec.

[Additional Explanation] Another reason may be there is dysfunction on the electronics on the motors

[Solution]

1. Shut down and reboot the robot
2. Make sure the payload (including the tool) is within the spec.
3. Adjust the speed or movement to prevent the risk of having a single joint accelerate too fast
4. If it still happens, export the Logs, Project and TCP used, and contact to your service engineer

ErrorSuggestion0015F053

[Cause]Robot has detected a overshoot of W phase current on the motor

[Caution]

1. Check the header of the error code to see which motor is with this issue
2. Check if the robot is run with payload out of spec. and also in high speed
3. Check if the safety settings of the robot

[Additional Explanation] If the robot is driven and accelerate fast, current of the motor will overshoot and trigger this error

[Additional Explanation] This is usually be triggered when running the robot with a heavy payload with high speed which is nearly or already out of spec.

[Additional Explanation] Another reason may be there is dysfunction on the electronics on the motors

[Solution]

1. Shut down and reboot the robot
2. Make sure the payload (including the tool) is within the spec.
3. Adjust the speed or movement to prevent the risk of having a single joint accelerate too fast
4. If it still happens, export the Logs, Project and TCP used, and contact to your service engineer

ErrorSuggestion0015F054

[Cause]Robot has detected the current on DCBUS went too high suddenly.

[Caution]

1. The speed (ABS/project speed) is too fast.
2. Check whether there is any collision while robot moving.

[Additional Explanations] If robot is moving in a high speed in some movement or pose, it would cause this error. And if robot has collisions, it would cause the current became abnormal.

[Solution][General User]

1. Slow down the speed (ABS/project speed).

ErrorSuggestion0015F055	<p>2. Avoid any collision while robot is moving.</p> <p>3. After restart the robot, the problem still occur, contact a qualified service engineer for further analysis.</p> <p>[Cause]</p> <ol style="list-style-type: none"> <li>1. Power supply is not stable.</li> <li>2. Robot moves in high speed, current is higher, voltage loss getting higher.(Vinput-Vloss=V for DC bus)</li> <li>3. Power connector problem, consume too much power</li> </ol> <p>[Additional Explanation] When robot is working and detects the voltage of DC bus is low, it will report this error</p> <p>[Solution]</p> <ol style="list-style-type: none"> <li>1. Power off the robot</li> <li>2. Check Robot Cable and its connector before power on again</li> <li>3. Reduce Robot speed if necessary</li> </ol>
ErrorSuggestion0015F056	<p>Make sure power source is stable</p> <p>[Cause]Robot detect the voltage on DCBUS is higher than spec.</p> <p>[Caution]Check whether there are others error log along with this error.</p> <p>[Additional Explanation] There may be a variety of reasons that cause a high voltage, for example:</p> <ol style="list-style-type: none"> <li>1. The robot move too fast with the current project (with heavy payload)</li> <li>2. Power eater modules is abnormal</li> <li>3. etc.</li> </ol> <p>[Precaution] Power off and unplug the power cable before opening the control box for items checking</p> <p>[Solution]</p> <ol style="list-style-type: none"> <li>1. Make sure the robot would not be collided and be placed on a unstable platform.</li> <li>2. Make sure project speed with payload is within the specification.</li> <li>3. After restart the robot, the problem still occur, contact a qualified service engineer for further analysis</li> </ol>
ErrorSuggestion0015F057	<ol style="list-style-type: none"> <li>1. Please try to restart the robot.</li> <li>2. If the restart is invalid, please contact the original purchase or third-party designated maintenance units.</li> </ol>
ErrorSuggestion0015F058	<p>[Cause] DC to DC component on Join PCB is damaged</p> <p>[Additional Explanation] When detect voltage of 1.65V is abnormal, it will report this error</p> <p>[Solution]</p> <ol style="list-style-type: none"> <li>1. Export the log file</li> <li>2. Contact a qualified service engineer</li> </ol>
ErrorSuggestion0015F059	<p>[Cause] DC to DC component on Join PCB is damaged</p> <p>[Additional Explanation] When detect voltage of 12V is abnormal, it will report this error</p> <p>[Solution]</p> <ol style="list-style-type: none"> <li>1. Export the log file</li> <li>2. Contact a qualified service engineer</li> </ol>
ErrorSuggestion0015F05A	<p>[Cause] DC to DC component on Join PCB is damaged</p> <p>[Additional Explanation] When detect voltage of 6V is abnormal, it will report this error</p> <p>[Solution]</p> <ol style="list-style-type: none"> <li>1. Export the log file</li> <li>2. Contact a qualified service engineer</li> </ol>
ErrorSuggestion0015F05B	<p>[Cause] DC to DC component on Join PCB is damaged</p> <p>[Additional Explanation] When detect voltage of 3.3V is abnormal, it will report this error</p> <p>[Solution]</p> <ol style="list-style-type: none"> <li>1. Export the log file</li> <li>2. Contact a qualified service engineer</li> </ol>
ErrorSuggestion0015F05C	<p>[Cause] DC to DC component on Join PCB is damaged</p> <p>[Additional Explanation] When detect voltage of 1.2V is abnormal, it will report this error</p>

ErrorSuggestion0015F061	<p>[Solution]</p> <ol style="list-style-type: none"> <li>1. Export the log file</li> <li>2. Contact a qualified service engineer</li> </ol> <p>[Cause] The speed command is too large</p>
ErrorSuggestion0015F062	<p>[Solution]</p> <ol style="list-style-type: none"> <li>1. Shut down and reboot the robot</li> <li>2. Reduce the motion speed, check the flow and the speed and posture in each node</li> <li>3. If it still happens, export the Logs, Project and TCP used, and contact to your service engineer</li> </ol> <p>[Cause] The deviation between target and current position is too large</p>
ErrorSuggestion0015F063	<p>[Solution]</p> <ol style="list-style-type: none"> <li>1. Shut down and reboot the robot</li> <li>2. Reduce the motion speed, check the flow, speed and posture in each node</li> <li>3. If it still happens, export the Logs, Project and TCP used, and contact to your service engineer</li> </ol> <p>[Cause] The motor output command rises sudden and triggers motor hold protection</p> <p>[Caution]</p> <ol style="list-style-type: none"> <li>1. Check if there robot has collided to the surroundings seriously</li> <li>2. Check the description of this error code to see which joint it belongs to</li> </ol> <p>[Additional Explanation] When the robot collides to a solid object in a high speed, some of the joints may suffer a great torque on them and this causes the motor current raise rapidly and trigger this error</p> <p>[Precaution] Do not drive the joint manually when this error occurs, which might damage the joint</p>
ErrorSuggestion0015F064	<p>[Solution]</p> <ol style="list-style-type: none"> <li>1. Shut down and reboot the robot</li> <li>2. Adjust the payload, safety settings, speed and see if the issue still happens</li> <li>3. Make sure the payload (including the tool) is within the spec.</li> <li>4. Adjust the speed or movement to prevent the risk of having a single joint accelerate too fast</li> <li>5. If it still happens, export the Logs, Project and TCP used, and contact to your service engineer</li> <li>6. Make sure the robot will not collide with the surroundings during project run</li> </ol> <p>[Cause] The motor current rises sudden and triggers motor hold protection</p> <p>[Caution]</p> <ol style="list-style-type: none"> <li>1. Check if there robot has collided to the surroundings seriously</li> <li>2. Check the description of this error code to see which joint it belongs to</li> </ol> <p>[Additional Explanation] When the robot collides to a solid object in a high speed, some of the joints may suffer a great torque on them and this causes the motor current raise rapidly and trigger this error</p> <p>[Precaution] Do not drive the joint manually when this error occurs, which might damage the joint</p>
ErrorSuggestion0015F071	<p>[Solution]</p> <ol style="list-style-type: none"> <li>1. Shut down and reboot the robot</li> <li>2. Adjust the payload, safety settings, speed and see if the issue still happens</li> <li>3. Make sure the payload (including the tool) is within the spec.</li> <li>4. Adjust the speed or movement to prevent the risk of having a single joint accelerate too fast</li> <li>5. If it still happens, export the Logs, Project and TCP used, and contact to your service engineer</li> <li>6. Make sure the robot will not collide with the surroundings during project run</li> </ol> <p>[Cause] Hardware Failure</p> <p>[Caution]</p> <p>[Additional Explanation] This error is not likely happens, mostly because of hardware issue</p> <p>[Solution]</p>

ErrorSuggestion0015F072	<p>1. Export the Logs</p> <p>2. Contact a qualified service engineer for further analysis</p> <p>[Cause] Robot detect the temperature on PCB is higher than spec.</p> <p>[Caution] 1. Check if the environment temperature is higher than the spec. while robot moving.</p> <p>2. Check the temperature on View-&gt;Status</p> <p>[Additional Explanation] The temperature would rise during robot operating and the work space temperature will affect as well.</p> <p>[Solution]</p> <p>1. Make sure the temperature of the working environment is within the specification.</p> <p>2. Make sure the payload or the project speed is within the specification</p> <p>3. Shut down the robot, and keep it cool for a while before start up again.</p> <p>4. If this issue still occurs, please contact a qualified service engineer for further analysis</p>
ErrorSuggestion0015F073	<p>[Cause] G sensor overload</p> <p>[Caution]</p> <p>1. Check if there robot has collided to the surroundings seriously</p> <p>2. Check the description of this error code to see which joint it belongs to</p> <p>[Solution]</p> <p>1. Adjust the payload, safety settings, speed and see if the issue still happens</p> <p>2. Make sure the payload (including the tool) is within the spec.</p> <p>3. Adjust the speed or movement to prevent the risk of having a single joint accelerate too fast</p> <p>4. If it still happens, export the Logs, Project and TCP used, and contact to your service engineer</p> <p>5. Make sure the robot will not collide with the surroundings during project run</p>
ErrorSuggestion0015F074	<p>[Cause] Hardware Failure</p> <p>[Caution]</p> <p>[Additional Explanation] This error is not likely happens, mostly because of hardware issue</p> <p>[Solution]</p> <p>1. Export the Logs</p> <p>2. Contact a qualified service engineer for further analysis</p>
ErrorSuggestion0015F075	<p>[Cause] Hardware Failure</p> <p>[Caution]</p> <p>[Restriction] Do not drive the joint with or without drive power when this issue happens</p> <p>[Solution]</p> <p>1. Export the Logs</p> <p>2. Contact a qualified service engineer for further analysis</p> <p>3. Make sure that the robot does not collide with the surroundings during operation</p>
ErrorSuggestion0015F0A4	Please contact the original purchase of the manufacturer or a third party designated maintenance unit.
ErrorSuggestion0015F0A5	Please contact the original purchase of the manufacturer or a third party designated maintenance unit.
ErrorSuggestion0015F0A6	Please contact the original purchase of the manufacturer or a third party designated maintenance unit.
ErrorSuggestion0015F111	Please contact the original purchase of the manufacturer or a third party designated maintenance unit.
ErrorSuggestion0015F112	Please contact the original purchase of the manufacturer or a third party designated maintenance unit.
ErrorSuggestion0015F113	Please contact the original purchase of the manufacturer or a third party designated maintenance unit.
ErrorSuggestion0015F114	Please contact the original purchase of the manufacturer or a third party designated maintenance unit.
ErrorSuggestion0015F115	<p>[Cause] Encoder is abnormal</p> <p>[Caution]</p> <p>[Additional Explanation] This error is not likely happens, mostly because of hardware issue</p> <p>[Solution]</p>



	<ol style="list-style-type: none"> <li>1. Export the log,</li> <li>2. Contact a qualified service engineer for further analysis</li> </ol>
ErrorSuggestion0015F116	<ol style="list-style-type: none"> <li>1. Please try to restart the robot.</li> <li>2. If the restart is invalid, please contact the original purchase or third-party designated maintenance units.</li> </ol>
ErrorSuggestion0015F117	<ol style="list-style-type: none"> <li>1. Please try to restart the robot.</li> <li>2. If the restart is invalid, please contact the original purchase or third-party designated maintenance units.</li> </ol>
ErrorSuggestion0015F118	<ol style="list-style-type: none"> <li>1. Please try to restart the robot.</li> <li>2. If the restart is invalid, please contact the original purchase or third-party designated maintenance units.</li> </ol>
ErrorSuggestion0015F119	<p>[Cause]</p> <ol style="list-style-type: none"> <li>1. Motor is damaged</li> <li>2. Joint PCB is damaged</li> </ol> <p>[Caution]</p> <p>[Additional Explanation] When the resistance of UVW current of motor is abnormal, it will report this error</p> <p>[Solution]</p> <ol style="list-style-type: none"> <li>1. Export the log file</li> <li>2. Contact a qualified service engineer</li> </ol>
ErrorSuggestion0015F11A	<p>[Cause]Hardware Failure</p> <p>[Caution]</p> <p>[Additional Explanation] The cables connection of UVW of motor is not correct. Quality issue or the robot may be disassembled abnormally.</p> <p>[Solution]</p> <ol style="list-style-type: none"> <li>1. Export the log file</li> <li>2. Contact a qualified service engineer</li> <li>3. Make sure the robot is not being disassembled illegally</li> </ol>
ErrorSuggestion0015F11B	<p>[Cause] Hardware Failure</p> <p>[Caution]</p> <p>[Restriction] Do not drive the joint with or without drive power when this issue happens</p> <p>[Solution]</p> <ol style="list-style-type: none"> <li>1. Export the Logs</li> <li>2. Contact a qualified service engineer for further analysis</li> <li>3. Make sure that the robot does not collide with the surroundings during operation</li> </ol>
ErrorSuggestion0015F121	Please contact the original purchase of the manufacturer or a third party designated maintenance unit.
ErrorSuggestion0015F122	Please contact the original purchase of the manufacturer or a third party designated maintenance unit.
ErrorSuggestion0015F123	Please contact the original purchase of the manufacturer or a third party designated maintenance unit.
ErrorSuggestion0015F124	Please contact the original purchase of the manufacturer or a third party designated maintenance unit.
ErrorSuggestion0015F125	Please contact the original purchase of the manufacturer or a third party designated maintenance unit.
ErrorSuggestion0015F126	Please contact the original purchase of the manufacturer or a third party designated maintenance unit.
ErrorSuggestion0015F127	Please contact the original purchase of the manufacturer or a third party designated maintenance unit.
ErrorSuggestion0015F128	Please contact the original purchase of the manufacturer or a third party designated maintenance unit.
ErrorSuggestion0015F129	<p>[Cause]Encoder is abnormal</p> <p>[Caution]</p> <p>[Additional Explanation] This error is not likely happens, mostly because of hardware issue</p> <p>[Solution]</p> <ol style="list-style-type: none"> <li>1. Export the log,</li> <li>2. Contact a qualified service engineer for further analysis</li> </ol>
ErrorSuggestion0015F12A	Please contact the original purchase of the manufacturer or a third party designated maintenance unit.
ErrorSuggestion0015F12B	Please contact the original purchase of the manufacturer or a third party designated maintenance unit.



ErrorSuggestion0015F131	<ol style="list-style-type: none"> <li>1. Please check grounding line is normal or not.</li> <li>2. Please contact the original purchase of the manufacturer or a third party designated maintenance unit.</li> </ol>
ErrorSuggestion0015F132	Please contact the original purchase of the manufacturer or a third party designated maintenance unit.
ErrorSuggestion0015F133	<p>[Cause] Robot detect a sudden voltage drop on DCBUS.</p> <p>[Caution]</p> <p>[Additional Explanation] There may be a variety of reasons that cause a low voltage, for example:</p> <ol style="list-style-type: none"> <li>1. The payload and speed may not in the spec.</li> <li>2. Power supply is abnormal</li> </ol> <p>[Precaution] Power off and unplug the power cable before opening the control box for items checking</p> <p>[Solution]</p> <ol style="list-style-type: none"> <li>1. Shut down the robot, make sure the power source is stable then power on.</li> <li>2. Make sure the power source is robust for robot running.</li> <li>3. Adjust the payload, safety settings, speed and see if the issue still happens</li> <li>4. Make sure the payload (including the tool) is within the spec.</li> <li>5. Adjust the speed or movement to prevent the risk of having a single joint accelerate too fast</li> <li>6. If it still happens, export the Logs, Project and TCP used, and contact to your service engineer</li> </ol>
ErrorSuggestion0015F134	<p>[Cause] The communication time of EtherCAT is timeout</p> <p>[Caution] Check if any external EtherCAT device used has lost connection</p> <p>[Additional Explanation] System will periodic check the EtherCAT communication, if communication timeout, it will report this error.</p> <p>[Solution]</p> <p>Contact a qualified service engineer for further analysis</p>
ErrorSuggestion0015F135	<p>[Cause] Joint movement range is over range during brake release process</p> <p>[Caution] Check if the payload is too that out of specification, including the mass, center of mass, inertia, etc.</p> <p>[Additional Explanation] System will detect the movement range while brake release process, when the value is over expected, it will report this error.</p> <p>[Solution]</p> <ol style="list-style-type: none"> <li>1. Power off the robot</li> <li>2. Remove all payload and restart the robot</li> <li>3. Make sure the payload is within specification (including the center of mass and inertia)</li> <li>4. Make sure there is no unexpected force acting on the robot during brake release process</li> <li>5. If this issue still happens, have a qualified service engineer for further analysis</li> </ol>
ErrorSuggestion0015F136	<p>[Cause] Current for solenoid is over specification during brake release process</p> <p>[Additional Explanation] System will detect the current for solenoid during brake releasing process, when it find the value over specification, it will report this error</p> <p>[Solution]</p> <ol style="list-style-type: none"> <li>1. Please press ESTOP button and release it to resume Robot to see the issue is still occurred or not.</li> <li>2. If this still occurs, contact a qualified service engineer for further analysis</li> </ol>
ErrorSuggestion0015F137	<p>[Cause] Robot detect a low voltage on DCBUS.</p> <p>[Caution]</p> <p>[Additional Explanation] There may be a variety of reasons that cause a low voltage, for example:</p> <ol style="list-style-type: none"> <li>1. The power source is not stable on customer-site</li> <li>2. Power supply is abnormal</li> <li>3. etc.</li> </ol> <p>[Precaution] Power off and unplug the power cable before opening the control box for items checking</p> <p>[Solution]</p> <ol style="list-style-type: none"> <li>1. Shut down the robot, make sure the power source is stable then power on.</li> </ol>

ErrorSuggestion0015F138	<p>2. Make sure the power source is robust for robot running.</p> <p>3. If the same issue still occurs, contact a qualified service engineer for further analysis</p> <p>[Cause] Robot detect the voltage on DCBUS is higher than spec.</p> <p>[Caution] Check whether there are others error log along with this error.</p> <p>[Additional Explanation] There may be a variety of reasons that cause a high voltage, for example:</p> <ol style="list-style-type: none"> <li>1. The robot move too fast with the current project (with heavy payload)</li> <li>2. Power eater modules is abnormal</li> <li>3. etc.</li> </ol> <p>[Precaution] Power off and unplug the power cable before opening the control box for items checking</p> <p>[Solution]</p> <ol style="list-style-type: none"> <li>1. Make sure the robot would not be collided and be placed on a unstable platform.</li> <li>2. Make sure project speed with payload is within the specification.</li> <li>3. After restart the robot, the problem still occur, contact a qualified service engineer for further analysis</li> </ol>
ErrorSuggestion0015F139	<p>[Cause] Robot detect a sudden voltage drop on DCBUS.</p> <p>[Caution]</p> <p>[Additional Explanation] There may be a variety of reasons that cause a low voltage, for example:</p> <ol style="list-style-type: none"> <li>1. The payload and speed may not in the spec.</li> <li>2. Power supply is abnormal</li> </ol> <p>[Precaution] Power off and unplug the power cable before opening the control box for items checking</p> <p>[Solution]</p> <ol style="list-style-type: none"> <li>1. Shut down the robot, make sure the power source is stable then power on.</li> <li>2. Make sure the power source is robust for robot running.</li> <li>3. Adjust the payload, safety settings, speed and see if the issue still happens</li> <li>4. Make sure the payload (including the tool) is within the spec.</li> <li>5. Adjust the speed or movement to prevent the risk of having a single joint accelerate too fast</li> <li>6. If it still happens, export the Logs, Project and TCP used, and contact to your service engineer</li> </ol>
ErrorSuggestion0015F141	<ol style="list-style-type: none"> <li>1. Please try to restart the robot.</li> <li>2. If the restart is invalid, please contact the original purchase or third-party designated maintenance units.</li> </ol>
ErrorSuggestion0015F142	<ol style="list-style-type: none"> <li>1. Please try to restart the robot.</li> <li>2. If the restart is invalid, please contact the original purchase or third-party designated maintenance units.</li> </ol>
ErrorSuggestion0015F143	<ol style="list-style-type: none"> <li>1. Please try to restart the robot.</li> <li>2. If the restart is invalid, please contact the original purchase or third-party designated maintenance units.</li> </ol>
ErrorSuggestion0015F144	<ol style="list-style-type: none"> <li>1. Please try to restart the robot.</li> <li>2. If the restart is invalid, please contact the original purchase or third-party designated maintenance units.</li> </ol>
ErrorSuggestion0015F145	<p>[Cause] Encoder is dysfunctional</p> <p>[Caution]</p> <p>[Additional Explanation] This error is not likely happens, mostly because of hardware issue</p> <p>[Solution]</p> <ol style="list-style-type: none"> <li>1. Export the Logs</li> <li>2. Contact a qualified service engineer for further analysis</li> </ol>
ErrorSuggestion0015F146	<p>[Cause] Encoder is dysfunctional</p> <p>[Caution]</p> <p>[Additional Explanation] This error is not likely happens, mostly because of hardware issue</p> <p>[Solution]</p> <ol style="list-style-type: none"> <li>1. Export the Logs</li> <li>2. Contact a qualified service engineer for further analysis</li> </ol>

ErrorSuggestion0015F147	<p>[Cause] Encoder is dysfunctional</p> <p>[Caution]</p> <p>[Additional Explanation] This error is not likely happens, mostly because of hardware issue</p> <p>[Solution]</p> <ol style="list-style-type: none"> <li>1. Export the Logs</li> <li>2. Contact a qualified service engineer for further analysis</li> </ol>
ErrorSuggestion0015F148	<p>[Cause] Encoder is dysfunctional</p> <p>[Caution]</p> <p>[Additional Explanation] This error is not likely happens, mostly because of hardware issue</p> <p>[Solution]</p> <ol style="list-style-type: none"> <li>1. Export the Logs</li> <li>2. Contact a qualified service engineer for further analysis</li> </ol>
ErrorSuggestion0015F149	<ol style="list-style-type: none"> <li>1. Please try to restart the robot.</li> <li>2. If the restart is invalid, please contact the original purchase or third-party designated maintenance units.</li> </ol>
ErrorSuggestion0015F1A1	<ol style="list-style-type: none"> <li>1. Please try to restart the robot.</li> <li>2. If the restart is invalid, please contact the original purchase or third-party designated maintenance units.</li> </ol>
ErrorSuggestion0015F1A2	<ol style="list-style-type: none"> <li>1. Please try to restart the robot.</li> <li>2. If the restart is invalid, please contact the original purchase or third-party designated maintenance units.</li> </ol>
ErrorSuggestion0015F1A3	<ol style="list-style-type: none"> <li>1. Please try to restart the robot.</li> <li>2. If the restart is invalid, please contact the original purchase or third-party designated maintenance units.</li> </ol>
ErrorSuggestion0015FF20	<p>[Cause] Current for solenoid is over specification during brake release process</p> <p>[Additional Explanation] System will detect the current for solenoid during brake releasing process, when it find the value over specification, it will report this error</p> <p>[Solution]</p> <ol style="list-style-type: none"> <li>1. Please press ESTOP button and release it to resume Robot to see the issue is still occurred or not.</li> <li>2. If this still occurs, contact a qualified service engineer for further analysis</li> </ol>
ErrorSuggestion0015FF21	<p>[Cause]Joint movement range is over range during brake release process</p> <p>[Caution]Check if the payload is too that out of specification, including the mass, center of mass, inertia, etc.</p> <p>[Additional Explanation] System will detect the movement range while brake release process, when the value is over expected, it will report this error.</p> <p>[Solution]</p> <ol style="list-style-type: none"> <li>1. Power off the robot</li> <li>2. Remove all payload and restart the robot</li> <li>3. Make sure the payload is within specification (including the center of mass and inertia)</li> <li>4. Make sure there is no unexpected force acting on the robot during brake release process</li> <li>5. If this issue still happens, have a qualified service engineer for further analysis</li> </ol>
ErrorSuggestion0015FFA0	<p>[Cause]Robot detect a low voltage on DCBUS.</p> <p>[Caution]Check if the payload is too that out of specification, including the mass, center of mass, inertia, etc.</p> <p>[Additional Explanation] There may be a variety of reasons that cause a low voltage, for example:</p> <ol style="list-style-type: none"> <li>1. The power source is not stable on customer-site</li> <li>2. Power supply is abnormal</li> <li>3. etc.</li> </ol> <p>[Precaution] Power off and unplug the power cable before opening the control box for items checking</p> <p>[Solution]</p> <p>Shut down the robot, make sure the power source is stable then power on. If the same issue still occurs, contact a qualified service engineer for further analysis</p> <p>Make sure the power source is robust for robot running.</p>

ErrorSuggestion0015FFA1	<p>[Cause]Robot detect the voltage on DCBUS is higher than spec.</p> <p>[Caution]Check whether there are others error log along with this error.</p> <p>[Additional Explanation] There may be a variety of reasons that cause a high voltage, for example:</p> <ol style="list-style-type: none"> <li>1. The robot move too fast with the current project (with heavy payload)</li> <li>2. Power eater modules is abnormal</li> <li>3. etc.</li> </ol> <p>[Precaution] Power off and unplug the power cable before opening the control box for items checking</p> <p>[Solution]</p> <p>After restart the robot, the problem still occur, contact a qualified service engineer for further analysis</p> <ol style="list-style-type: none"> <li>1. Make sure the robot would not be collided and be placed on a unstable platform.</li> <li>2. Make sure project speed with payload is within the specification.</li> </ol>
ErrorSuggestion0015FFA2	Be careful! G sensor overload on X direction.
ErrorSuggestion0015FFA3	Be careful! G sensor overload on Y direction.
ErrorSuggestion0015FFA4	Be careful! G sensor overload on Z direction.
ErrorSuggestion0015FFA5	<p>[Cause]Robot detect the temperature on PCB is higher than spec.</p> <p>[Caution]1. Check if the environment temperature is higher than the spec. while robot moving.</p> <ol style="list-style-type: none"> <li>2. Check the temperature on View-&gt;Status</li> </ol> <p>[Additional Explanation] The temperature would rise during robot operating and the work space temperature will affect as well.</p> <p>[Solution]</p> <p>Shut down the robot, and keep it cool for a while before start up again. If this issue still occurs, please contact a qualified service engineer for further analysis</p> <ol style="list-style-type: none"> <li>1. Make sure the temperature of the working environment is within the specification.</li> <li>2. Make sure the payload or the project speed is within the specification</li> </ol>
ErrorSuggestion0015FFA6	<p>[Cause]Robot has detected an overshoot of U phase current on the motor</p> <p>[Caution]</p> <ol style="list-style-type: none"> <li>1. Check the header of the error code to see which motor is with this issue</li> <li>2. Check if the robot is run with payload out of spec. and also in high speed</li> <li>3. Check if the safety settings of the robot</li> </ol> <p>[Additional Explanation] If the robot is driven and accelerate fast, current of the motor will overshoot and trigger this error</p> <p>[Additional Explanation] This is usually be triggered when running the robot with a heavy payload with high speed which is nearly or already out of spec.</p> <p>[Additional Explanation] Another reason may be there is dysfunction on the electronics on the motors</p> <p>[Solution]</p> <ol style="list-style-type: none"> <li>1. Shut down and reboot the robot</li> <li>2. Adjust the payload, safety settings, speed and see if the issue still happens</li> <li>3. Make sure the payload (including the tool) is within the spec.</li> <li>4. Adjust the speed or movement to prevent the risk of having a single joint accelerate too fast</li> <li>5. If it still happens, export the Logs, Project and TCP used, and contact to your service engineer</li> </ol>
ErrorSuggestion0015FFA7	<p>[Cause]Robot has detected a overshoot of V phase current on the motor</p> <p>[Caution]</p> <ol style="list-style-type: none"> <li>1. Check the header of the error code to see which motor is with this issue</li> <li>2. Check if the robot is run with payload out of spec. and also in high speed</li> <li>3. Check if the safety settings of the robot</li> </ol> <p>[Additional Explanation] If the robot is driven and accelerate fast, current of the motor will overshoot and trigger this error</p>

ErrorSuggestion0015FFA8	<p>[Additional Explanation] This is usually be triggered when running the robot with a heavy payload with high speed which is nearly or already out of spec.</p> <p>[Additional Explanation] Another reason may be there is dysfunction on the electronics on the motors</p> <p>[Solution]</p> <ol style="list-style-type: none"> <li>1. Shut down and reboot the robot</li> <li>2. Adjust the payload, safety settings, speed and see if the issue still happens</li> <li>3. Make sure the payload (including the tool) is within the spec.</li> <li>4. Adjust the speed or movement to prevent the risk of having a single joint accelerate too fast</li> <li>5. If it still happens, export the Logs, Project and TCP used, and contact to your service engineer</li> </ol> <p>[Cause]Robot has detected a overshoot of W phase current on the motor</p> <p>[Caution]</p> <ol style="list-style-type: none"> <li>1. Check the header of the error code to see which motor is with this issue</li> <li>2. Check if the robot is run with payload out of spec. and also in high speed</li> <li>3. Check if the safety settings of the robot</li> </ol> <p>[Additional Explanation] If the robot is driven and accelerate fast, current of the motor will overshoot and trigger this error</p>
ErrorSuggestion0015FFA9	<p>[Additional Explanation] This is usually be triggered when running the robot with a heavy payload with high speed which is nearly or already out of spec.</p>
ErrorSuggestion0015FFAA	<p>[Additional Explanation] Another reason may be there is dysfunction on the electronics on the motors</p>
ErrorSuggestion0015FFAB	<p>[Solution]</p> <ol style="list-style-type: none"> <li>1. Shut down and reboot the robot</li> <li>2. Adjust the payload, safety settings, speed and see if the issue still happens</li> <li>3. Make sure the payload (including the tool) is within the spec.</li> <li>4. Adjust the speed or movement to prevent the risk of having a single joint accelerate too fast</li> <li>5. If it still happens, export the Logs, Project and TCP used, and contact to your service engineer</li> </ol> <p>Be careful! Motor current protection on U phase triggered, which may be caused by impact.</p> <p>Be careful! Motor current protection on V phase triggered, which may be caused by impact.</p> <p>[Cause]The motor current rises sudden and triggers motor hold protection</p> <p>[Caution]</p> <ol style="list-style-type: none"> <li>1. Check if there robot has collided to the surroundings seriously</li> <li>2. Check the description of this error code to see which joint it belongs to</li> </ol> <p>[Additional Explanation] When the robot collides to a solid object in a high speed, some of the joints may suffer a great torque on them and this causes the motor current raise rapidly and trigger this error</p>
ErrorSuggestion0015FFAC	<p>[Precaution] Do not drive the joint manually when this error occurs, which might damage the joint</p>
ErrorSuggestion0015FFAD	<p>[Solution]</p> <ol style="list-style-type: none"> <li>1. Shut down and reboot the robot</li> <li>2. Adjust the payload, safety settings, speed and see if the issue still happens</li> <li>3. Make sure the payload (including the tool) is within the spec.</li> <li>4. Adjust the speed or movement to prevent the risk of having a single joint accelerate too fast</li> <li>5. If it still happens, export the Logs, Project and TCP used, and contact to your service engineer</li> <li>6. Make sure the robot will not collide with the surroundings during project run</li> </ol>
ErrorSuggestion0015FFAE	<p>a error occurred in the UVW signal on optical encoder</p> <p>The index of encoder is not calibrated.</p> <p>[Cause]Robot has detected the current on DCBUS went too high suddenly.</p> <p>[Caution]</p> <ol style="list-style-type: none"> <li>1. The speed(ABS/project speed) is too fast.</li> </ol>

	<p>2. Check whether there is any collision while robot moving.</p> <p>[Additional Explanations] If robot is moving in a high speed in some movement or pose, it would cause this error. And if robot has collisions, it would cause the current became abnormal.</p> <p>[Solution][General User]</p> <ol style="list-style-type: none"> <li>1. Slow down the speed(ABS/project speed).</li> <li>2. Avoid any collision while robot is moving.</li> <li>3. After restart the robot, the problem still occur, contact a qualified service engineer for further analysis.</li> </ol>
ErrorSuggestion0015FFAF	<p>[Cause] The communication time of EtherCAT is timeout</p> <p>[Caution] Check if any external EtherCAT device used has lost connection</p> <p>[Additional Explanation] System will periodic check the EtherCAT communication, if communication timeout, it will report this error.</p> <p>[Solution]</p> <p>Contact a qualified service engineer for further analysis</p>
ErrorSuggestion0015FFB1	<p>[Cause] The communication time of SPI is timeout</p> <p>[Caution]</p> <p>[Additional Explanation] It may possibly because the SPI IC is dysfunction which is not likely to happen</p> <p>[Solution]</p> <p>Contact a qualified service engineer for further analysis</p>
ErrorSuggestion0015FFB2	<ol style="list-style-type: none"> <li>1. Please check grounding line is normal or not.</li> <li>2. Please contact the original purchase of the manufacturer or a third party designated maintenance unit.</li> </ol>
ErrorSuggestion0015FFB3	Please contact the original purchase of the manufacturer or a third party designated maintenance unit.
ErrorSuggestion0015FFB4	<ol style="list-style-type: none"> <li>1. Please try to restart the robot.</li> <li>2. If the restart is invalid, please contact the original purchase or third-party designated maintenance units.</li> </ol>
ErrorSuggestion0015FFB5	<ol style="list-style-type: none"> <li>1. Please try to restart the robot.</li> <li>2. If the restart is invalid, please contact the original purchase or third-party designated maintenance units.</li> </ol>
ErrorSuggestion0015FFB6	Please contact the original purchase of the manufacturer or a third party designated maintenance unit.
ErrorSuggestion0015FFB7	Please check the functionality of break unit
ErrorSuggestion0015FFB8	<p>[Cause] Hardware Failure</p> <p>[Caution]</p> <p>[Additional Explanation] This error is not likely happens, mostly because of hardware issue</p> <p>[Solution]</p> <ol style="list-style-type: none"> <li>1. Export the Logs</li> <li>2. Contact a qualified service engineer for further analysis</li> </ol>
ErrorSuggestion0015FFB9	<p>[Cause] Hardware Failure</p> <p>[Caution]</p> <p>[Additional Explanation] This error is not likely happens, mostly because of hardware issue</p> <p>[Solution]</p> <ol style="list-style-type: none"> <li>1. Export the Logs</li> <li>2. Contact a qualified service engineer for further analysis</li> </ol>
ErrorSuggestion0015FFBA	<p>[Cause] Hardware Failure</p> <p>[Caution]</p> <p>[Restriction] Do not pull the joint forcibly when the problem occurs, so as not to cause damage to the joint</p> <p>[Solution]</p> <ol style="list-style-type: none"> <li>1. Export the Logs</li> <li>2. Contact a qualified service engineer for further analysis</li> <li>3. Make sure that the robot does not collide with the surroundings during operation</li> </ol>
ErrorSuggestion0015FFC0	a error occurred in transit to absolute position

ErrorSuggestion0015FFC1	Please contact the original purchase of the manufacturer or a third party designated maintenance unit.
ErrorSuggestion0015FFC2	Please contact the original purchase of the manufacturer or a third party designated maintenance unit.
ErrorSuggestion0015FFC3	Please contact the original purchase of the manufacturer or a third party designated maintenance unit.
ErrorSuggestion0015FFC4	Please contact the original purchase of the manufacturer or a third party designated maintenance unit.
ErrorSuggestion0015FFC5	Please contact the original purchase of the manufacturer or a third party designated maintenance unit.
ErrorSuggestion0015FFC6	Please contact the original purchase of the manufacturer or a third party designated maintenance unit.
ErrorSuggestion0015FFC7	Please contact the original purchase of the manufacturer or a third party designated maintenance unit.
ErrorSuggestion0015FFC8	Please contact the original purchase of the manufacturer or a third party designated maintenance unit.
ErrorSuggestion0015FFC9	Please contact the original purchase of the manufacturer or a third party designated maintenance unit.
ErrorSuggestion0015FFCA	[Cause] Encoder is dysfunctional [Caution] [Additional Explanation] This error is not likely happens, mostly because of hardware issue [Solution] 1. Export the Logs 2. Contact a qualified service engineer for further analysis
ErrorSuggestion0015FFCB	Please reduce the motion speed, check the flow and the speed and posture in each node
ErrorSuggestion0015FFCC	[Cause] Encoder is dysfunctional [Caution] [Additional Explanation] This error is not likely happens, mostly because of hardware issue [Solution] 1. Export the Logs 2. Contact a qualified service engineer for further analysis
ErrorSuggestion0015FFCD	[Cause] Hardware Failure [Caution] [Restriction] Do not drive the joint with or without drive power when this issue happens [Solution] 1. Export the Logs 2. Contact a qualified service engineer for further analysis 3. Make sure that the robot does not collide with the surroundings during operation
ErrorSuggestion0015FFCE	[Cause] Hardware Failure [Caution] [Restriction] Do not drive the joint with or without drive power [Solution] 1. Export the Logs 2. Contact a qualified service engineer for further analysis
ErrorSuggestion0015FFCF	[Cause] The motor current rises sudden and triggers motor hold protection [Caution] 1. Check if there robot has collided to the surroundings seriously 2. Check the description of this error code to see which joint it belongs to [Additional Explanation] When the robot collides to a solid object in a high speed, some of the joints may suffer a great torque on them and this causes the motor current raise rapidly and trigger this error  [Precaution] Do not drive the joint manually when this error occurs, which might damage the joint [Solution] 1. Shut down and reboot the robot 2. Adjust the payload, safety settings, speed and see if the issue still happens 3. Make sure the payload (including the tool) is within the spec.



	<p>4. Adjust the speed or movement to prevent the risk of having a single joint accelerate too fast</p> <p>5. If it still happens, export the Logs, Project and TCP used, and contact to your service engineer</p> <p>6. Make sure the robot will not collide with the surroundings during project run</p>
ErrorSuggestion0015FFD0	Please check the UVW signal on encoder
ErrorSuggestion0015FFD1	<p>[Cause] Hardware Failure</p> <p>[Caution] Check if the robot is placed near any device with strong magnetic field</p> <p>[Additional Explanation] Under a strong magnetic field may affect the readings of the magnetic encoder</p> <p>[Solution]</p> <ol style="list-style-type: none"> <li>1. Export the Logs</li> <li>2. Make sure the robot is not under any strong magnetic field and then reboot the robot</li> <li>3. If this still does not work, Contact a qualified service engineer for further analysis</li> </ol>
ErrorSuggestion0015FFD2	<p>[Cause] Hardware Failure</p> <p>[Caution] Check if the robot is placed near any device with strong magnetic field</p> <p>[Additional Explanation] Under a strong magnetic field may affect the readings of the magnetic encoder</p> <p>[Solution]</p> <ol style="list-style-type: none"> <li>1. Export the Logs</li> <li>2. Make sure the robot is not under any strong magnetic field and then reboot the robot</li> <li>3. If this still does not work, Contact a qualified service engineer for further analysis</li> </ol>
ErrorSuggestion0015FFD3	<p>[Cause]</p> <ol style="list-style-type: none"> <li>1. The robot may be disassembled abnormally. Please check the warranty sticker and thread-locking fluid are both broken or not</li> <li>2. Joint gear wear out</li> </ol> <p>[Caution]</p> <p>[Additional Explanation] When the origin of joint module is not detected, it will report this error</p> <p>[Solution]</p> <ol style="list-style-type: none"> <li>1. Export the Logs</li> <li>2. Contact a qualified service engineer for further analysis</li> </ol>
ErrorSuggestion0015FFD4	Please contact the original purchase of the manufacturer or a third party designated maintenance unit.
ErrorSuggestion0015FFD5	Please contact the original purchase of the manufacturer or a third party designated maintenance unit.
ErrorSuggestion0015FFD6	Please contact the original purchase of the manufacturer or a third party designated maintenance unit.
ErrorSuggestion0015FFD7	Please contact the original purchase of the manufacturer or a third party designated maintenance unit.
ErrorSuggestion0015FFD8	<p>[Cause]</p> <ol style="list-style-type: none"> <li>1. Motor is damaged</li> <li>2. Joint PCB is damaged</li> </ol> <p>[Additional Explanation] When the resistance of UVW current of motor is abnormal, it will report this error</p> <p>[Solution]</p> <ol style="list-style-type: none"> <li>1. Export the log file</li> <li>2. Contact a qualified service engineer</li> </ol>
ErrorSuggestion0015FFD9	<p>[Cause] Hardware Failure</p> <p>[Additional Explanation] The cables connection of UVW of motor is not correct. Quality issue or the robot may be disassembled abnormally.</p> <p>[Solution]</p> <ol style="list-style-type: none"> <li>1. Export the log file</li> <li>2. Contact a qualified service engineer</li> <li>3. Make sure the robot is not being disassembled illegally</li> </ol>
ErrorSuggestion0015FFDA	Please contact the original purchase of the manufacturer or a third party designated maintenance unit.
ErrorSuggestion0015FFDB	Please contact the original purchase of the manufacturer or a third party designated maintenance unit.



ErrorSuggestion0015FFDC	Please contact the original purchase of the manufacturer or a third party designated maintenance unit.
ErrorSuggestion0015FFDD	1. Please restart the robot. 2. If the restart is invalid, please contact the original purchase or third-party designated maintenance units.
ErrorSuggestion0015FFDE	1. Please restart the robot. 2. If the restart is invalid, please contact the original purchase or third-party designated maintenance units.
ErrorSuggestion0015FFDF	1. Please restart the robot. 2. If the restart is invalid, please contact the original purchase or third-party designated maintenance units.
ErrorSuggestion0015FFE0	[Cause] 1. Power supply is not stable. 2. Robot moves in high speed, current is higher, voltage loss getting higher.(Vinput-Vloss=V for DC bus) 3. Power connector problem, consume too much power [Additional Explanation] When robot is working and detects the voltage of DC bus is low, it will report this error [Solution] 1. Power off the robot 2. Check Robot Cable and its connector before power on again 3. Reduce Robot speed if necessary Make sure power source is stable
ErrorSuggestion0015FFE1	Please contact the original purchase of the manufacturer or a third party designated maintenance unit.
ErrorSuggestion0015FFE2	1. Please restart the robot. 2. If the restart is invalid, please contact the original purchase or third-party designated maintenance units.
ErrorSuggestion0015FFE3	1. Please restart the robot. 2. If the restart is invalid, please contact the original purchase or third-party designated maintenance units.
ErrorSuggestion0015FFE4	[Cause] Encoder is abnormal [Additional Explanation] This error is not likely happens, mostly because of hardware issue [Solution] 1. Export the log file 2. Contact a qualified service engineer
ErrorSuggestion0015FFE5	1. Please restart the robot. 2. If the restart is invalid, please contact the original purchase or third-party designated maintenance units.
ErrorSuggestion0015FFE6	1. Please restart the robot. 2. If the restart is invalid, please contact the original purchase or third-party designated maintenance units.
ErrorSuggestion0015FFE7	Please contact the original purchase of the manufacturer or a third party designated maintenance unit.
ErrorSuggestion0015FFE8	[Cause]Hardware Failure [Additional Explanation] When the output of the G sensor is abnormal, it will report this error [Solution] 1. Export the log file 2. Contact a qualified service engineer
ErrorSuggestion0015FFE9	Please contact the original purchase of the manufacturer or a third party designated maintenance unit.
ErrorSuggestion0015FFEA	[Cause] DC to DC component on Join PCB is damaged [Additional Explanation] When detect voltage of 5V is abnormal, it will report this error [Solution] 1. Export the log file 2. Contact a qualified service engineer
ErrorSuggestion0015FFEB	[Cause] DC to DC component on Join PCB is damaged [Additional Explanation] When detect voltage of 12V is abnormal, it will report this error [Solution]

ErrorSuggestion0015FFEC ErrorSuggestion0015FFED	<ol style="list-style-type: none"> <li>1. Export the log file</li> <li>2. Contact a qualified service engineer</li> </ol> <p>Please contact the original purchase of the manufacturer or a third party designated maintenance unit.</p> <p>[Cause] Encoder abnormal</p> <p>[Additional Explanation] This error is not likely happens, mostly because of hardware issue</p> <p>[Solution]</p> <p>[Solution]</p>
ErrorSuggestion0015FFEE	<ol style="list-style-type: none"> <li>1. Export the log file</li> <li>2. Contact a qualified service engineer</li> </ol> <p>Please turn on joint modules</p>
ErrorSuggestion0015FFEF	Please contact the original purchase of the manufacturer or a third party designated maintenance unit.
ErrorSuggestion00250000	No Error
ErrorSuggestion0025F051	<p>[Cause]Robot has detected an overshoot of U phase current on the motor</p> <p>[Caution]</p> <ol style="list-style-type: none"> <li>1. Check the header of the error code to see which motor is with this issue</li> <li>2. Check if the robot is run with payload out of spec and also in high speed</li> <li>3. Check if the safety settings of the robot</li> </ol> <p>[Additional Explanation] If the robot is driven and accelerate fast, current of the motor will overshoot and trigger this error</p> <p>[Additional Explanation] This is usually be triggered when running the robot with a heavy payload with high speed which is nearly or already out of spec.</p> <p>[Additional Explanation] Another reason may be there is dysfunction on the electronics on the motors</p> <p>[Solution]</p> <ol style="list-style-type: none"> <li>1. Shut down and reboot the robot</li> <li>2. Make sure the payload (including the tool) is within the spec.</li> <li>3. Adjust the speed or movement to prevent the risk of having a single joint accelerate too fast</li> <li>4. If it still happens, export the Logs, Project and TCP used, and contact to your service engineer</li> </ol>
ErrorSuggestion0025F052	<p>[Cause]Robot has detected a overshoot of V phase current on the motor</p> <p>[Caution]</p> <ol style="list-style-type: none"> <li>1. Check the header of the error code to see which motor is with this issue</li> <li>2. Check if the robot is run with payload out of spec. and also in high speed</li> <li>3. Check if the safety settings of the robot</li> </ol> <p>[Additional Explanation] If the robot is driven and accelerate fast, current of the motor will overshoot and trigger this error</p> <p>[Additional Explanation] This is usually be triggered when running the robot with a heavy payload with high speed which is nearly or already out of spec.</p> <p>[Additional Explanation] Another reason may be there is dysfunction on the electronics on the motors</p> <p>[Solution]</p> <ol style="list-style-type: none"> <li>1. Shut down and reboot the robot</li> <li>2. Make sure the payload (including the tool) is within the spec.</li> <li>3. Adjust the speed or movement to prevent the risk of having a single joint accelerate too fast</li> <li>4. If it still happens, export the Logs, Project and TCP used, and contact to your service engineer</li> </ol>
ErrorSuggestion0025F053	<p>[Cause]Robot has detected a overshoot of W phase current on the motor</p> <p>[Caution]</p> <ol style="list-style-type: none"> <li>1. Check the header of the error code to see which motor is with this issue</li> <li>2. Check if the robot is run with payload out of spec. and also in high speed</li> <li>3. Check if the safety settings of the robot</li> </ol>

ErrorSuggestion0025F054	<p>[Additional Explanation] If the robot is driven and accelerate fast, current of the motor will overshoot and trigger this error</p> <p>[Additional Explanation] This is usually be triggered when running the robot with a heavy payload with high speed which is nearly or already out of spec.</p> <p>[Additional Explanation] Another reason may be there is dysfunction on the electronics on the motors</p> <p>[Solution]</p> <ol style="list-style-type: none"> <li>1. Shut down and reboot the robot</li> <li>2. Make sure the payload (including the tool) is within the spec.</li> <li>3. Adjust the speed or movement to prevent the risk of having a single joint accelerate too fast</li> <li>4. If it still happens, export the Logs, Project and TCP used, and contact to your service engineer</li> </ol> <p>[Cause]Robot has detected the current on DCBUS went too high suddenly.</p> <p>[Caution]</p> <ol style="list-style-type: none"> <li>1. The speed (ABS/project speed) is too fast.</li> <li>2. Check whether there is any collision while robot moving.</li> </ol> <p>[Additional Explanations] If robot is moving in a high speed in some movement or pose, it would cause this error. And if robot has collisions, it would cause the current became abnormal.</p>
ErrorSuggestion0025F055	<p>[Solution][General User]</p> <ol style="list-style-type: none"> <li>1. Slow down the speed (ABS/project speed).</li> <li>2. Avoid any collision while robot is moving.</li> <li>3. After restart the robot, the problem still occur, contact a qualified service engineer for further analysis.</li> </ol> <p>[Cause]</p> <ol style="list-style-type: none"> <li>1. Power supply is not stable.</li> <li>2. Robot moves in high speed, current is higher, voltage loss getting higher.(<math>V_{input}-V_{loss}=V</math> for DC bus)</li> <li>3. Power connector problem, consume too much power</li> </ol> <p>[Additional Explanation] When robot is working and detects the voltage of DC bus is low, it will report this error</p>
ErrorSuggestion0025F056	<p>[Solution]</p> <ol style="list-style-type: none"> <li>1. Power off the robot</li> <li>2. Check Robot Cable and its connector before power on again</li> <li>3. Reduce Robot speed if necessary</li> </ol> <p>Make sure power source is stable</p> <p>[Cause]Robot detect the voltage on DCBUS is higher than spec.</p> <p>[Caution]Check whether there are others error log along with this error.</p> <p>[Additional Explanation] There may be a variety of reasons that cause a high voltage, for example:</p> <ol style="list-style-type: none"> <li>1. The robot move too fast with the current project (with heavy payload)</li> <li>2. Power eater modules is abnormal</li> <li>3. etc.</li> </ol> <p>[Precaution] Power off and unplug the power cable before opening the control box for items checking</p>
ErrorSuggestion0025F057	<p>[Solution]</p> <ol style="list-style-type: none"> <li>1. Make sure the robot would not be collided and be placed on a unstable platform.</li> <li>2. Make sure project speed with payload is within the specification.</li> <li>3. After restart the robot, the problem still occur, contact a qualified service engineer for further analysis</li> </ol>
ErrorSuggestion0025F057	<ol style="list-style-type: none"> <li>1. Please try to restart the robot.</li> <li>2. If the restart is invalid, please contact the original purchase or third-party designated maintenance units.</li> </ol>
ErrorSuggestion0025F058	<p>[Cause] DC to DC component on Join PCB is damaged</p> <p>[Additional Explanation] When detect voltage of 1.65V is abnormal, it will report this error</p> <p>[Solution]</p>

ErrorSuggestion0025F059	<ol style="list-style-type: none"> <li>1. Export the log file</li> <li>2. Contact a qualified service engineer</li> </ol> <p>[Cause] DC to DC component on Join PCB is damaged</p> <p>[Additional Explanation] When detect voltage of 12V is abnormal, it will report this error</p> <p>[Solution]</p> <ol style="list-style-type: none"> <li>1. Export the log file</li> <li>2. Contact a qualified service engineer</li> </ol>
ErrorSuggestion0025F05A	<ol style="list-style-type: none"> <li>1. Export the log file</li> <li>2. Contact a qualified service engineer</li> </ol> <p>[Cause] DC to DC component on Join PCB is damaged</p> <p>[Additional Explanation] When detect voltage of 6V is abnormal, it will report this error</p> <p>[Solution]</p> <ol style="list-style-type: none"> <li>1. Export the log file</li> <li>2. Contact a qualified service engineer</li> </ol>
ErrorSuggestion0025F05B	<ol style="list-style-type: none"> <li>1. Export the log file</li> <li>2. Contact a qualified service engineer</li> </ol> <p>[Cause] DC to DC component on Join PCB is damaged</p> <p>[Additional Explanation] When detect voltage of 3.3V is abnormal, it will report this error</p> <p>[Solution]</p> <ol style="list-style-type: none"> <li>1. Export the log file</li> <li>2. Contact a qualified service engineer</li> </ol>
ErrorSuggestion0025F05C	<ol style="list-style-type: none"> <li>1. Export the log file</li> <li>2. Contact a qualified service engineer</li> </ol> <p>[Cause] DC to DC component on Join PCB is damaged</p> <p>[Additional Explanation] When detect voltage of 1.2V is abnormal, it will report this error</p> <p>[Solution]</p> <ol style="list-style-type: none"> <li>1. Export the log file</li> <li>2. Contact a qualified service engineer</li> </ol>
ErrorSuggestion0025F061	<ol style="list-style-type: none"> <li>1. Export the log file</li> <li>2. Contact a qualified service engineer</li> </ol> <p>[Cause] The speed command is too large</p> <p>[Solution]</p> <ol style="list-style-type: none"> <li>1. Shut down and reboot the robot</li> <li>2. Reduce the motion speed, check the flow and the speed and posture in each node</li> <li>3. If it still happens, export the Logs, Project and TCP used, and contact to your service engineer</li> </ol>
ErrorSuggestion0025F062	<ol style="list-style-type: none"> <li>1. Export the log file</li> <li>2. Contact a qualified service engineer</li> </ol> <p>[Cause] The deviation between target and current position is too large</p> <p>[Solution]</p> <ol style="list-style-type: none"> <li>1. Shut down and reboot the robot</li> <li>2. Reduce the motion speed, check the flow, speed and posture in each node</li> <li>3. If it still happens, export the Logs, Project and TCP used, and contact to your service engineer</li> </ol>
ErrorSuggestion0025F063	<ol style="list-style-type: none"> <li>1. Export the log file</li> <li>2. Contact a qualified service engineer</li> </ol> <p>[Cause] The motor output command rises sudden and triggers motor hold protection</p> <p>[Caution]</p> <ol style="list-style-type: none"> <li>1. Check if there robot has collided to the surroundings seriously</li> <li>2. Check the description of this error code to see which joint it belongs to</li> </ol> <p>[Additional Explanation] When the robot collides to a solid object in a high speed, some of the joints may suffer a great torque on them and this causes the motor current raise rapidly and trigger this error</p> <p>[Precaution] Do not drive the joint manually when this error occurs, which might damage the joint</p> <p>[Solution]</p> <ol style="list-style-type: none"> <li>1. Shut down and reboot the robot</li> <li>2. Adjust the payload, safety settings, speed and see if the issue still happens</li> <li>3. Make sure the payload (including the tool) is within the spec.</li> <li>4. Adjust the speed or movement to prevent the risk of having a single joint accelerate too fast</li> <li>5. If it still happens, export the Logs, Project and TCP used, and contact to your service engineer</li> <li>6. Make sure the robot will not collide with the surroundings during project run</li> </ol>

ErrorSuggestion0025F064	<p>[Cause] The motor current rises sudden and triggers motor hold protection</p> <p>[Caution]</p> <ol style="list-style-type: none"> <li>1. Check if there robot has collided to the surroundings seriously</li> <li>2. Check the description of this error code to see which joint it belongs to</li> </ol> <p>[Additional Explanation] When the robot collides to a solid object in a high speed, some of the joints may suffer a great torque on them and this causes the motor current raise rapidly and trigger this error</p> <p>[Precaution] Do not drive the joint manually when this error occurs, which might damage the joint</p> <p>[Solution]</p> <ol style="list-style-type: none"> <li>1. Shut down and reboot the robot</li> <li>2. Adjust the payload, safety settings, speed and see if the issue still happens</li> <li>3. Make sure the payload (including the tool) is within the spec.</li> <li>4. Adjust the speed or movement to prevent the risk of having a single joint accelerate too fast</li> <li>5. If it still happens, export the Logs, Project and TCP used, and contact to your service engineer</li> <li>6. Make sure the robot will not collide with the surroundings during project run</li> </ol>
ErrorSuggestion0025F071	<p>[Cause] Hardware Failure</p> <p>[Caution]</p> <p>[Additional Explanation] This error is not likely happens, mostly because of hardware issue</p> <p>[Solution]</p> <ol style="list-style-type: none"> <li>1. Export the Logs</li> <li>2. Contact a qualified service engineer for further analysis</li> </ol>
ErrorSuggestion0025F072	<p>[Cause] Robot detect the temperature on PCB is higher than spec.</p> <p>[Caution]</p> <ol style="list-style-type: none"> <li>1. Check if the environment temperature is higher than the spec. while robot moving.</li> <li>2. Check the temperature on View-&gt;Status</li> </ol> <p>[Additional Explanation] The temperature would rise during robot operating and the work space temperature will affect as well.</p> <p>[Solution]</p> <ol style="list-style-type: none"> <li>1. Make sure the temperature of the working environment is within the specification.</li> <li>2. Make sure the payload or the project speed is within the specification</li> <li>3. Shut down the robot, and keep it cool for a while before start up again.</li> <li>4. If this issue still occurs, please contact a qualified service engineer for further analysis</li> </ol>
ErrorSuggestion0025F073	<p>[Cause] G sensor overload</p> <p>[Caution]</p> <ol style="list-style-type: none"> <li>1. Check if there robot has collided to the surroundings seriously</li> <li>2. Check the description of this error code to see which joint it belongs to</li> </ol> <p>[Solution]</p> <ol style="list-style-type: none"> <li>1. Adjust the payload, safety settings, speed and see if the issue still happens</li> <li>2. Make sure the payload (including the tool) is within the spec.</li> <li>3. Adjust the speed or movement to prevent the risk of having a single joint accelerate too fast</li> <li>4. If it still happens, export the Logs, Project and TCP used, and contact to your service engineer</li> <li>5. Make sure the robot will not collide with the surroundings during project run</li> </ol>
ErrorSuggestion0025F074	<p>[Cause] Hardware Failure</p> <p>[Caution]</p> <p>[Additional Explanation] This error is not likely happens, mostly because of hardware issue</p> <p>[Solution]</p> <ol style="list-style-type: none"> <li>1. Export the Logs</li> <li>2. Contact a qualified service engineer for further analysis</li> </ol>

ErrorSuggestion0025F075	<p>[Cause] Hardware Failure</p> <p>[Caution]</p> <p>[Restriction] Do not drive the joint with or without drive power when this issue happens</p> <p>[Solution]</p> <ol style="list-style-type: none"> <li>1. Export the Logs</li> <li>2. Contact a qualified service engineer for further analysis</li> <li>3. Make sure that the robot does not collide with the surroundings during operation</li> </ol>
ErrorSuggestion0025F0A4	Please contact the original purchase of the manufacturer or a third party designated maintenance unit.
ErrorSuggestion0025F0A5	Please contact the original purchase of the manufacturer or a third party designated maintenance unit.
ErrorSuggestion0025F0A6	Please contact the original purchase of the manufacturer or a third party designated maintenance unit.
ErrorSuggestion0025F111	Please contact the original purchase of the manufacturer or a third party designated maintenance unit.
ErrorSuggestion0025F112	Please contact the original purchase of the manufacturer or a third party designated maintenance unit.
ErrorSuggestion0025F113	Please contact the original purchase of the manufacturer or a third party designated maintenance unit.
ErrorSuggestion0025F114	Please contact the original purchase of the manufacturer or a third party designated maintenance unit.
ErrorSuggestion0025F115	<p>[Cause]Encoder is abnormal</p> <p>[Caution]</p> <p>[Additional Explanation] This error is not likely happens, mostly because of hardware issue</p> <p>[Solution]</p> <ol style="list-style-type: none"> <li>1. Export the log,</li> <li>2. Contact a qualified service engineer for further analysis</li> </ol>
ErrorSuggestion0025F116	<ol style="list-style-type: none"> <li>1. Please try to restart the robot.</li> <li>2. If the restart is invalid, please contact the original purchase or third-party designated maintenance units.</li> </ol>
ErrorSuggestion0025F117	<ol style="list-style-type: none"> <li>1. Please try to restart the robot.</li> <li>2. If the restart is invalid, please contact the original purchase or third-party designated maintenance units.</li> </ol>
ErrorSuggestion0025F118	<ol style="list-style-type: none"> <li>1. Please try to restart the robot.</li> <li>2. If the restart is invalid, please contact the original purchase or third-party designated maintenance units.</li> </ol>
ErrorSuggestion0025F119	<p>[Cause]</p> <ol style="list-style-type: none"> <li>1. Motor is damaged</li> <li>2. Joint PCB is damaged</li> </ol> <p>[Caution]</p> <p>[Additional Explanation] When the resistance of UVW current of motor is abnormal, it will report this error</p> <p>[Solution]</p> <ol style="list-style-type: none"> <li>1. Export the log file</li> <li>2. Contact a qualified service engineer</li> </ol>
ErrorSuggestion0025F11A	<p>[Cause]Hardware Failure</p> <p>[Caution]</p> <p>[Additional Explanation] The cables connection of UVW of motor is not correct. Quality issue or the robot may be disassembled abnormally.</p> <p>[Solution]</p> <ol style="list-style-type: none"> <li>1. Export the log file</li> <li>2. Contact a qualified service engineer</li> <li>3. Make sure the robot is not being disassembled illegally</li> </ol>
ErrorSuggestion0025F11B	<p>[Cause] Hardware Failure</p> <p>[Caution]</p> <p>[Restriction] Do not drive the joint with or without drive power when this issue happens</p> <p>[Solution]</p> <ol style="list-style-type: none"> <li>1. Export the Logs</li> </ol>

	2. Contact a qualified service engineer for further analysis
	3. Make sure that the robot does not collide with the surroundings during operation
ErrorSuggestion0025F121	Please contact the original purchase of the manufacturer or a third party designated maintenance unit.
ErrorSuggestion0025F122	Please contact the original purchase of the manufacturer or a third party designated maintenance unit.
ErrorSuggestion0025F123	Please contact the original purchase of the manufacturer or a third party designated maintenance unit.
ErrorSuggestion0025F124	Please contact the original purchase of the manufacturer or a third party designated maintenance unit.
ErrorSuggestion0025F125	Please contact the original purchase of the manufacturer or a third party designated maintenance unit.
ErrorSuggestion0025F126	Please contact the original purchase of the manufacturer or a third party designated maintenance unit.
ErrorSuggestion0025F127	Please contact the original purchase of the manufacturer or a third party designated maintenance unit.
ErrorSuggestion0025F128	Please contact the original purchase of the manufacturer or a third party designated maintenance unit.
ErrorSuggestion0025F129	[Cause]Encoder is abnormal [Caution] [Additional Explanation] This error is not likely happens, mostly because of hardware issue [Solution] 1. Export the log, 2. Contact a qualified service engineer for further analysis
ErrorSuggestion0025F12A	Please contact the original purchase of the manufacturer or a third party designated maintenance unit.
ErrorSuggestion0025F12B	Please contact the original purchase of the manufacturer or a third party designated maintenance unit.
ErrorSuggestion0025F131	1. Please check grounding line is normal or not. 2. Please contact the original purchase of the manufacturer or a third party designated maintenance unit.
ErrorSuggestion0025F132	Please contact the original purchase of the manufacturer or a third party designated maintenance unit.
ErrorSuggestion0025F133	[Cause]Robot detect a sudden voltage drop on DCBUS. [Caution] [Additional Explanation] There may be a variety of reasons that cause a low voltage, for example: 1. The payload and speed may not in the spec. 2. Power supply is abnormal [Precaution] Power off and unplug the power cable before opening the control box for items checking [Solution] 1. Shut down the robot, make sure the power source is stable then power on. 2. Make sure the power source is robust for robot running. 3. Adjust the payload, safety settings, speed and see if the issue still happens 4. Make sure the payload (including the tool) is within the spec. 5. Adjust the speed or movement to prevent the risk of having a single joint accelerate too fast 6. If it still happens, export the Logs, Project and TCP used, and contact to your service engineer
ErrorSuggestion0025F134	[Cause] The communication time of EtherCAT is timeout [Caution] Check if any external EtherCAT device used has lost connection [Additional Explanation] System will periodic check the EtherCAT communication, if communication timeout, it will report this error. [Solution] Contact a qualified service engineer for further analysis
ErrorSuggestion0025F135	[Cause]Joint movement range is over range during brake release process [Caution]Check if the payload is too that out of specification, including the mass, center of mass, inertia, etc. [Additional Explanation] System will detect the movement range while brake release process, when the value is over expected, it will report this error. [Solution] 1. Power off the robot 2. Remove all payload and restart the robot



ErrorSuggestion0025F136	<p>3. Make sure the payload is within specification (including the center of mass and inertia)</p> <p>4. Make sure there is no unexpected force acting on the robot during brake release process</p> <p>5. If this issue still happens, have a qualified service engineer for further analysis</p> <p>[Cause] Current for solenoid is over specification during brake release process</p> <p>[Additional Explanation] System will detect the current for solenoid during brake releasing process, when it find the value over specification, it will report this error</p> <p>[Solution]</p> <ol style="list-style-type: none"> <li>1. Please press ESTOP button and release it to resume Robot to see the issue is still occurred or not.</li> <li>2. If this still occurs, contact a qualified service engineer for further analysis</li> </ol>
ErrorSuggestion0025F137	<p>[Cause] Robot detect a low voltage on DCBUS.</p> <p>[Caution]</p> <p>[Additional Explanation] There may be a variety of reasons that cause a low voltage, for example:</p> <ol style="list-style-type: none"> <li>1. The power source is not stable on customer-site</li> <li>2. Power supply is abnormal</li> <li>3. etc.</li> </ol> <p>[Precaution] Power off and unplug the power cable before opening the control box for items checking</p> <p>[Solution]</p> <ol style="list-style-type: none"> <li>1. Shut down the robot, make sure the power source is stable then power on.</li> <li>2. Make sure the power source is robust for robot running.</li> <li>3. If the same issue still occurs, contact a qualified service engineer for further analysis</li> </ol>
ErrorSuggestion0025F138	<p>[Cause] Robot detect the voltage on DCBUS is higher than spec.</p> <p>[Caution] Check whether there are others error log along with this error.</p> <p>[Additional Explanation] There may be a variety of reasons that cause a high voltage, for example:</p> <ol style="list-style-type: none"> <li>1. The robot move too fast with the current project (with heavy payload)</li> <li>2. Power eater modules is abnormal</li> <li>3. etc.</li> </ol> <p>[Precaution] Power off and unplug the power cable before opening the control box for items checking</p> <p>[Solution]</p> <ol style="list-style-type: none"> <li>1. Make sure the robot would not be collided and be placed on a unstable platform.</li> <li>2. Make sure project speed with payload is within the specification.</li> <li>3. After restart the robot, the problem still occur, contact a qualified service engineer for further analysis</li> </ol>
ErrorSuggestion0025F139	<p>[Cause] Robot detect a sudden voltage drop on DCBUS.</p> <p>[Caution]</p> <p>[Additional Explanation] There may be a variety of reasons that cause a low voltage, for example:</p> <ol style="list-style-type: none"> <li>1. The payload and speed may not in the spec.</li> <li>2. Power supply is abnormal</li> </ol> <p>[Precaution] Power off and unplug the power cable before opening the control box for items checking</p> <p>[Solution]</p> <ol style="list-style-type: none"> <li>1. Shut down the robot, make sure the power source is stable then power on.</li> <li>2. Make sure the power source is robust for robot running.</li> <li>3. Adjust the payload, safety settings, speed and see if the issue still happens</li> <li>4. Make sure the payload (including the tool) is within the spec.</li> <li>5. Adjust the speed or movement to prevent the risk of having a single joint accelerate too fast</li> <li>6. If it still happens, export the Logs, Project and TCP used, and contact to your service engineer</li> </ol>
ErrorSuggestion0025F141	<ol style="list-style-type: none"> <li>1. Please try to restart the robot.</li> <li>2. If the restart is invalid, please contact the original purchase or third-party designated maintenance units.</li> </ol>



ErrorSuggestion0025F142	<ol style="list-style-type: none"> <li>1. Please try to restart the robot.</li> <li>2. If the restart is invalid, please contact the original purchase or third-party designated maintenance units.</li> </ol>
ErrorSuggestion0025F143	<ol style="list-style-type: none"> <li>1. Please try to restart the robot.</li> <li>2. If the restart is invalid, please contact the original purchase or third-party designated maintenance units.</li> </ol>
ErrorSuggestion0025F144	<ol style="list-style-type: none"> <li>1. Please try to restart the robot.</li> <li>2. If the restart is invalid, please contact the original purchase or third-party designated maintenance units.</li> </ol>
ErrorSuggestion0025F145	<p>[Cause] Encoder is dysfunctional</p> <p>[Caution]</p> <p>[Additional Explanation] This error is not likely happens, mostly because of hardware issue</p> <p>[Solution]</p> <ol style="list-style-type: none"> <li>1. Export the Logs</li> <li>2. Contact a qualified service engineer for further analysis</li> </ol>
ErrorSuggestion0025F146	<p>[Cause] Encoder is dysfunctional</p> <p>[Caution]</p> <p>[Additional Explanation] This error is not likely happens, mostly because of hardware issue</p> <p>[Solution]</p> <ol style="list-style-type: none"> <li>1. Export the Logs</li> <li>2. Contact a qualified service engineer for further analysis</li> </ol>
ErrorSuggestion0025F147	<p>[Cause] Encoder is dysfunctional</p> <p>[Caution]</p> <p>[Additional Explanation] This error is not likely happens, mostly because of hardware issue</p> <p>[Solution]</p> <ol style="list-style-type: none"> <li>1. Export the Logs</li> <li>2. Contact a qualified service engineer for further analysis</li> </ol>
ErrorSuggestion0025F148	<p>[Cause] Encoder is dysfunctional</p> <p>[Caution]</p> <p>[Additional Explanation] This error is not likely happens, mostly because of hardware issue</p> <p>[Solution]</p> <ol style="list-style-type: none"> <li>1. Export the Logs</li> <li>2. Contact a qualified service engineer for further analysis</li> </ol>
ErrorSuggestion0025F149	<ol style="list-style-type: none"> <li>1. Please try to restart the robot.</li> <li>2. If the restart is invalid, please contact the original purchase or third-party designated maintenance units.</li> </ol>
ErrorSuggestion0025F1A1	<ol style="list-style-type: none"> <li>1. Please try to restart the robot.</li> <li>2. If the restart is invalid, please contact the original purchase or third-party designated maintenance units.</li> </ol>
ErrorSuggestion0025F1A2	<ol style="list-style-type: none"> <li>1. Please try to restart the robot.</li> <li>2. If the restart is invalid, please contact the original purchase or third-party designated maintenance units.</li> </ol>
ErrorSuggestion0025F1A3	<ol style="list-style-type: none"> <li>1. Please try to restart the robot.</li> <li>2. If the restart is invalid, please contact the original purchase or third-party designated maintenance units.</li> </ol>
ErrorSuggestion0025FF20	<p>[Cause] Current for solenoid is over specification during brake release process</p> <p>[Additional Explanation] System will detect the current for solenoid during brake releasing process, when it find the value over specification, it will report this error</p> <p>[Solution]</p> <ol style="list-style-type: none"> <li>1. Please press ESTOP button and release it to resume Robot to see the issue is still occurred or not.</li> <li>2. If this still occurs, contact a qualified service engineer for further analysis</li> </ol>
ErrorSuggestion0025FF21	<p>[Cause]Joint movement range is over range during brake release process</p> <p>[Caution]Check if the payload is too that out of specification, including the mass, center of mass, inertia, etc.</p> <p>[Additional Explanation] System will detect the movement range while brake release process, when the value is over</p>

	<p>expected, it will report this error.</p> <p>[Solution]</p> <ol style="list-style-type: none"> <li>1. Power off the robot</li> <li>2. Remove all payload and restart the robot</li> <li>3. Make sure the payload is within specification (including the center of mass and inertia)</li> <li>4. Make sure there is no unexpected force acting on the robot during brake release process</li> <li>5. If this issue still happens, have a qualified service engineer for further analysis</li> </ol>
ErrorSuggestion0025FFA0	<p>[Cause]Robot detect a low voltage on DCBUS.</p> <p>[Caution]Check if the payload is too that out of specification, including the mass, center of mass, inertia, etc.</p> <p>[Additional Explanation] There may be a variety of reasons that cause a low voltage, for example:</p> <ol style="list-style-type: none"> <li>1. The power source is not stable on customer-site</li> <li>2. Power supply is abnormal</li> <li>3. etc.</li> </ol> <p>[Precaution] Power off and unplug the power cable before opening the control box for items checking</p> <p>[Solution]</p> <p>Shut down the robot, make sure the power source is stable then power on. If the same issue still occurs, contact a qualified service engineer for further analysis</p> <p>Make sure the power source is robust for robot running.</p>
ErrorSuggestion0025FFA1	<p>[Cause]Robot detect the voltage on DCBUS is higher than spec.</p> <p>[Caution]Check whether there are others error log along with this error.</p> <p>[Additional Explanation] There may be a variety of reasons that cause a high voltage, for example:</p> <ol style="list-style-type: none"> <li>1. The robot move too fast with the current project (with heavy payload)</li> <li>2. Power eater modules is abnormal</li> <li>3. etc.</li> </ol> <p>[Precaution] Power off and unplug the power cable before opening the control box for items checking</p> <p>[Solution]</p> <p>After restart the robot, the problem still occur, contact a qualified service engineer for further analysis</p> <ol style="list-style-type: none"> <li>1. Make sure the robot would not be collided and be placed on a unstable platform.</li> <li>2. Make sure project speed with payload is within the specification.</li> </ol>
ErrorSuggestion0025FFA2	Be careful! G sensor overload on X direction.
ErrorSuggestion0025FFA3	Be careful! G sensor overload on Y direction.
ErrorSuggestion0025FFA4	Be careful! G sensor overload on Z direction.
ErrorSuggestion0025FFA5	<p>[Cause]Robot detect the temperature on PCB is higher than spec.</p> <p>[Caution]1. Check if the environment temperature is higher than the spec. while robot moving.</p> <p>2. Check the temperature on View-&gt;Status</p> <p>[Additional Explanation] The temperature would rise during robot operating and the work space temperature will affect as well.</p> <p>[Solution]</p> <p>Shut down the robot, and keep it cool for a while before start up again. If this issue still occurs, please contact a qualified service engineer for further analysis</p> <ol style="list-style-type: none"> <li>1. Make sure the temperature of the working environment is within the specification.</li> <li>2. Make sure the payload or the project speed is within the specification</li> </ol>
ErrorSuggestion0025FFA6	<p>[Cause]Robot has detected an overshoot of U phase current on the motor</p> <p>[Caution]</p> <ol style="list-style-type: none"> <li>1. Check the header of the error code to see which motor is with this issue</li> <li>2. Check if the robot is run with payload out of spec. and also in high speed</li> <li>3. Check if the safety settings of the robot</li> </ol>

ErrorSuggestion0025FFA7

[Additional Explanation] If the robot is driven and accelerate fast, current of the motor will overshoot and trigger this error

[Additional Explanation] This is usually be triggered when running the robot with a heavy payload with high speed which is nearly or already out of spec.

[Additional Explanation] Another reason may be there is dysfunction on the electronics on the motors

[Solution]

1. Shut down and reboot the robot
2. Adjust the payload, safety settings, speed and see if the issue still happens
3. Make sure the payload (including the tool) is within the spec.
4. Adjust the speed or movement to prevent the risk of having a single joint accelerate too fast
5. If it still happens, export the Logs, Project and TCP used, and contact to your service engineer

[Cause]Robot has detected a overshoot of V phase current on the motor

[Caution]

1. Check the header of the error code to see which motor is with this issue
2. Check if the robot is run with payload out of spec. and also in high speed
3. Check if the safety settings of the robot

[Additional Explanation] If the robot is driven and accelerate fast, current of the motor will overshoot and trigger this error

[Additional Explanation] This is usually be triggered when running the robot with a heavy payload with high speed which is nearly or already out of spec.

[Additional Explanation] Another reason may be there is dysfunction on the electronics on the motors

[Solution]

1. Shut down and reboot the robot
2. Adjust the payload, safety settings, speed and see if the issue still happens
3. Make sure the payload (including the tool) is within the spec.
4. Adjust the speed or movement to prevent the risk of having a single joint accelerate too fast
5. If it still happens, export the Logs, Project and TCP used, and contact to your service engineer

[Cause]Robot has detected a overshoot of W phase current on the motor

[Caution]

1. Check the header of the error code to see which motor is with this issue
2. Check if the robot is run with payload out of spec. and also in high speed
3. Check if the safety settings of the robot

[Additional Explanation] If the robot is driven and accelerate fast, current of the motor will overshoot and trigger this error

[Additional Explanation] This is usually be triggered when running the robot with a heavy payload with high speed which is nearly or already out of spec.

[Additional Explanation] Another reason may be there is dysfunction on the electronics on the motors

[Solution]

1. Shut down and reboot the robot
2. Adjust the payload, safety settings, speed and see if the issue still happens
3. Make sure the payload (including the tool) is within the spec.
4. Adjust the speed or movement to prevent the risk of having a single joint accelerate too fast
5. If it still happens, export the Logs, Project and TCP used, and contact to your service engineer

ErrorSuggestion0025FFA9

Be careful! Motor current protection on U phase triggered, which may be caused by impact.

ErrorSuggestion0025FFAA

Be careful! Motor current protection on V phase triggered, which may be caused by impact.

ErrorSuggestion0025FFAB

[Cause]The motor current rises sudden and triggers motor hold protection

[Caution]

	<ol style="list-style-type: none"> <li>1. Check if there robot has collided to the surroundings seriously</li> <li>2. Check the description of this error code to see which joint it belongs to</li> </ol> <p>[Additional Explanation] When the robot collides to a solid object in a high speed, some of the joints may suffer a great torque on them and this causes the motor current raise rapidly and trigger this error</p> <p>[Precaution] Do not drive the joint manually when this error occurs, which might damage the joint</p> <p>[Solution]</p> <ol style="list-style-type: none"> <li>1. Shut down and reboot the robot</li> <li>2. Adjust the payload, safety settings, speed and see if the issue still happens</li> <li>3. Make sure the payload (including the tool) is within the spec.</li> <li>4. Adjust the speed or movement to prevent the risk of having a single joint accelerate too fast</li> <li>5. If it still happens, export the Logs, Project and TCP used, and contact to your service engineer</li> <li>6. Make sure the robot will not collide with the surroundings during project run</li> </ol>
ErrorSuggestion0025FFAC	a error occurred in the UVW signal on optical encoder
ErrorSuggestion0025FFAD	The index of encoder is not calibrated.
ErrorSuggestion0025FFAE	<p>[Cause] Robot has detected the current on DCBUS went too high suddenly.</p> <p>[Caution]</p> <ol style="list-style-type: none"> <li>1. The speed(ABS/project speed) is too fast.</li> <li>2. Check whether there is any collision while robot moving.</li> </ol> <p>[Additional Explanations] If robot is moving in a high speed in some movement or pose, it would cause this error. And if robot has collisions, it would cause the current became abnormal.</p> <p>[Solution][General User]</p> <ol style="list-style-type: none"> <li>1. Slow down the speed(ABS/project speed).</li> <li>2. Avoid any collision while robot is moving.</li> <li>3. After restart the robot, the problem still occur, contact a qualified service engineer for further analysis.</li> </ol>
ErrorSuggestion0025FFAF	<p>[Cause] The communication time of EtherCAT is timeout</p> <p>[Caution] Check if any external EtherCAT device used has lost connection</p> <p>[Additional Explanation] System will periodic check the EtherCAT communication, if communication timeout, it will report this error.</p> <p>[Solution]</p> <p>Contact a qualified service engineer for further analysis</p>
ErrorSuggestion0025FFB1	<p>[Cause] The communication time of SPI is timeout</p> <p>[Caution]</p> <p>[Additional Explanation] It may possibly because the SPI IC is dysfunction which is not likely to happen</p> <p>[Solution]</p> <p>Contact a qualified service engineer for further analysis</p>
ErrorSuggestion0025FFB2	<ol style="list-style-type: none"> <li>1. Please check grounding line is normal or not.</li> <li>2. Please contact the original purchase of the manufacturer or a third party designated maintenance unit.</li> </ol>
ErrorSuggestion0025FFB3	Please contact the original purchase of the manufacturer or a third party designated maintenance unit.
ErrorSuggestion0025FFB4	<ol style="list-style-type: none"> <li>1. Please try to restart the robot.</li> <li>2. If the restart is invalid, please contact the original purchase or third-party designated maintenance units.</li> </ol>
ErrorSuggestion0025FFB5	<ol style="list-style-type: none"> <li>1. Please try to restart the robot.</li> <li>2. If the restart is invalid, please contact the original purchase or third-party designated maintenance units.</li> </ol>
ErrorSuggestion0025FFB6	Please contact the original purchase of the manufacturer or a third party designated maintenance unit.
ErrorSuggestion0025FFB7	Please check the functionality of break unit
ErrorSuggestion0025FFB8	<p>[Cause] Hardware Failure</p> <p>[Caution]</p>

	[Additional Explanation] This error is not likely happens, mostly because of hardware issue
	[Solution]
	1. Export the Logs
	2. Contact a qualified service engineer for further analysis
ErrorSuggestion0025FFB9	[Cause] Hardware Failure
	[Caution]
	[Additional Explanation] This error is not likely happens, mostly because of hardware issue
	[Solution]
	1. Export the Logs
	2. Contact a qualified service engineer for further analysis
ErrorSuggestion0025FFBA	[Cause] Hardware Failure
	[Caution]
	[Restriction] Do not pull the joint forcibly when the problem occurs, so as not to cause damage to the joint
	[Solution]
	1. Export the Logs
	2. Contact a qualified service engineer for further analysis
	3. Make sure that the robot does not collide with the surroundings during operation
ErrorSuggestion0025FFC0	a error occurred in transit to absolute position
ErrorSuggestion0025FFC1	Please contact the original purchase of the manufacturer or a third party designated maintenance unit.
ErrorSuggestion0025FFC2	Please contact the original purchase of the manufacturer or a third party designated maintenance unit.
ErrorSuggestion0025FFC3	Please contact the original purchase of the manufacturer or a third party designated maintenance unit.
ErrorSuggestion0025FFC4	Please contact the original purchase of the manufacturer or a third party designated maintenance unit.
ErrorSuggestion0025FFC5	Please contact the original purchase of the manufacturer or a third party designated maintenance unit.
ErrorSuggestion0025FFC6	Please contact the original purchase of the manufacturer or a third party designated maintenance unit.
ErrorSuggestion0025FFC7	Please contact the original purchase of the manufacturer or a third party designated maintenance unit.
ErrorSuggestion0025FFC8	Please contact the original purchase of the manufacturer or a third party designated maintenance unit.
ErrorSuggestion0025FFC9	Please contact the original purchase of the manufacturer or a third party designated maintenance unit.
ErrorSuggestion0025FFCA	[Cause] Encoder is dysfunctional
	[Caution]
	[Additional Explanation] This error is not likely happens, mostly because of hardware issue
	[Solution]
	1. Export the Logs
	2. Contact a qualified service engineer for further analysis
ErrorSuggestion0025FFCB	Please reduce the motion speed, check the flow and the speed and posture in each node
ErrorSuggestion0025FFCC	[Cause] Encoder is dysfunctional
	[Caution]
	[Additional Explanation] This error is not likely happens, mostly because of hardware issue
	[Solution]
	1. Export the Logs
	2. Contact a qualified service engineer for further analysis
ErrorSuggestion0025FFCD	[Cause] Hardware Failure
	[Caution]
	[Restriction] Do not drive the joint with or without drive power when this issue happens
	[Solution]
	1. Export the Logs
	2. Contact a qualified service engineer for further analysis
	3. Make sure that the robot does not collide with the surroundings during operation

ErrorSuggestion0025FFCE	<p>[Cause] Hardware Failure</p> <p>[Caution]</p> <p>[Restriction] Do not drive the joint with or without drive power</p> <p>[Solution]</p> <ol style="list-style-type: none"> <li>1. Export the Logs</li> <li>2. Contact a qualified service engineer for further analysis</li> </ol>
ErrorSuggestion0025FFCF	<p>[Cause] The motor current rises sudden and triggers motor hold protection</p> <p>[Caution]</p> <ol style="list-style-type: none"> <li>1. Check if there robot has collided to the surroundings seriously</li> <li>2. Check the description of this error code to see which joint it belongs to</li> </ol> <p>[Additional Explanation] When the robot collides to a solid object in a high speed, some of the joints may suffer a great torque on them and this causes the motor current raise rapidly and trigger this error</p> <p>[Precaution] Do not drive the joint manually when this error occurs, which might damage the joint</p> <p>[Solution]</p> <ol style="list-style-type: none"> <li>1. Shut down and reboot the robot</li> <li>2. Adjust the payload, safety settings, speed and see if the issue still happens</li> <li>3. Make sure the payload (including the tool) is within the spec.</li> <li>4. Adjust the speed or movement to prevent the risk of having a single joint accelerate too fast</li> <li>5. If it still happens, export the Logs, Project and TCP used, and contact to your service engineer</li> <li>6. Make sure the robot will not collide with the surroundings during project run</li> </ol>
ErrorSuggestion0025FFD0	Please check the UVW signal on encoder
ErrorSuggestion0025FFD1	<p>[Cause] Hardware Failure</p> <p>[Caution] Check if the robot is placed near any device with strong magnetic field</p> <p>[Additional Explanation] Under a strong magnetic field may affect the readings of the magnetic encoder</p> <p>[Solution]</p> <ol style="list-style-type: none"> <li>1. Export the Logs</li> <li>2. Make sure the robot is not under any strong magnetic field and then reboot the robot</li> <li>3. If this still does not work, Contact a qualified service engineer for further analysis</li> </ol>
ErrorSuggestion0025FFD2	<p>[Cause] Hardware Failure</p> <p>[Caution] Check if the robot is placed near any device with strong magnetic field</p> <p>[Additional Explanation] Under a strong magnetic field may affect the readings of the magnetic encoder</p> <p>[Solution]</p> <ol style="list-style-type: none"> <li>1. Export the Logs</li> <li>2. Make sure the robot is not under any strong magnetic field and then reboot the robot</li> <li>3. If this still does not work, Contact a qualified service engineer for further analysis</li> </ol>
ErrorSuggestion0025FFD3	<p>[Cause]</p> <ol style="list-style-type: none"> <li>1. The robot may be disassembled abnormally. Please check the warranty sticker and thread-locking fluid are both broken or not</li> <li>2. Joint gear wear out</li> </ol> <p>[Caution]</p> <p>[Additional Explanation] When the origin of joint module is not detected, it will report this error</p> <p>[Solution]</p> <ol style="list-style-type: none"> <li>1. Export the Logs</li> <li>2. Contact a qualified service engineer for further analysis</li> </ol>
ErrorSuggestion0025FFD4	Please contact the original purchase of the manufacturer or a third party designated maintenance unit.
ErrorSuggestion0025FFD5	Please contact the original purchase of the manufacturer or a third party designated maintenance unit.

ErrorSuggestion0025FFD6	Please contact the original purchase of the manufacturer or a third party designated maintenance unit.
ErrorSuggestion0025FFD7	Please contact the original purchase of the manufacturer or a third party designated maintenance unit.
ErrorSuggestion0025FFD8	[Cause] <ol style="list-style-type: none"> <li>1. Motor is damaged</li> <li>2. Joint PCB is damaged</li> </ol> [Additional Explanation] When the resistance of UVW current of motor is abnormal, it will report this error [Solution] <ol style="list-style-type: none"> <li>1. Export the log file</li> <li>2. Contact a qualified service engineer</li> </ol>
ErrorSuggestion0025FFD9	[Cause] Hardware Failure [Additional Explanation] The cables connection of UVW of motor is not correct. Quality issue or the robot may be disassembled abnormally. [Solution] <ol style="list-style-type: none"> <li>1. Export the log file</li> <li>2. Contact a qualified service engineer</li> <li>3. Make sure the robot is not being disassembled illegally</li> </ol>
ErrorSuggestion0025FFDA	Please contact the original purchase of the manufacturer or a third party designated maintenance unit.
ErrorSuggestion0025FFDB	Please contact the original purchase of the manufacturer or a third party designated maintenance unit.
ErrorSuggestion0025FFDC	Please contact the original purchase of the manufacturer or a third party designated maintenance unit.
ErrorSuggestion0025FFDD	<ol style="list-style-type: none"> <li>1. Please restart the robot.</li> <li>2. If the restart is invalid, please contact the original purchase or third-party designated maintenance units.</li> </ol>
ErrorSuggestion0025FFDE	<ol style="list-style-type: none"> <li>1. Please restart the robot.</li> <li>2. If the restart is invalid, please contact the original purchase or third-party designated maintenance units.</li> </ol>
ErrorSuggestion0025FFDF	<ol style="list-style-type: none"> <li>1. Please restart the robot.</li> <li>2. If the restart is invalid, please contact the original purchase or third-party designated maintenance units.</li> </ol>
ErrorSuggestion0025FFE0	[Cause] <ol style="list-style-type: none"> <li>1. Power supply is not stable.</li> <li>2. Robot moves in high speed, current is higher, voltage loss getting higher. (<math>V_{input} - V_{loss} = V</math> for DC bus)</li> <li>3. Power connector problem, consume too much power</li> </ol> [Additional Explanation] When robot is working and detects the voltage of DC bus is low, it will report this error [Solution] <ol style="list-style-type: none"> <li>1. Power off the robot</li> <li>2. Check Robot Cable and its connector before power on again</li> <li>3. Reduce Robot speed if necessary</li> </ol> Make sure power source is stable
ErrorSuggestion0025FFE1	Please contact the original purchase of the manufacturer or a third party designated maintenance unit.
ErrorSuggestion0025FFE2	<ol style="list-style-type: none"> <li>1. Please restart the robot.</li> <li>2. If the restart is invalid, please contact the original purchase or third-party designated maintenance units.</li> </ol>
ErrorSuggestion0025FFE3	<ol style="list-style-type: none"> <li>1. Please restart the robot.</li> <li>2. If the restart is invalid, please contact the original purchase or third-party designated maintenance units.</li> </ol>
ErrorSuggestion0025FFE4	[Cause] Encoder is abnormal [Additional Explanation] This error is not likely happens, mostly because of hardware issue [Solution] <ol style="list-style-type: none"> <li>1. Export the log file</li> <li>2. Contact a qualified service engineer</li> </ol>
ErrorSuggestion0025FFE5	<ol style="list-style-type: none"> <li>1. Please restart the robot.</li> <li>2. If the restart is invalid, please contact the original purchase or third-party designated maintenance units.</li> </ol>



ErrorSuggestion0025FFE6	1. Please restart the robot. 2. If the restart is invalid, please contact the original purchase or third-party designated maintenance units.
ErrorSuggestion0025FFE7	Please contact the original purchase of the manufacturer or a third party designated maintenance unit.
ErrorSuggestion0025FFE8	[Cause]Hardware Failure [Additional Explanation] When the output of the G sensor is abnormal, it will report this error [Solution] 1. Export the log file 2. Contact a qualified service engineer
ErrorSuggestion0025FFE9	Please contact the original purchase of the manufacturer or a third party designated maintenance unit.
ErrorSuggestion0025FFEA	[Cause] DC to DC component on Join PCB is damaged [Additional Explanation] When detect voltage of 5V is abnormal, it will report this error [Solution] 1. Export the log file 2. Contact a qualified service engineer
ErrorSuggestion0025FFEB	[Cause] DC to DC component on Join PCB is damaged [Additional Explanation] When detect voltage of 12V is abnormal, it will report this error [Solution] 1. Export the log file 2. Contact a qualified service engineer
ErrorSuggestion0025FFEC	Please contact the original purchase of the manufacturer or a third party designated maintenance unit.
ErrorSuggestion0025FFED	[Cause] Encoder abnormal [Additional Explanation] This error is not likely happens, mostly because of hardware issue [Solution] [Solution] 1. Export the log file 2. Contact a qualified service engineer
ErrorSuggestion0025FFEE	Please turn on joint modules
ErrorSuggestion0025FFEF	Please contact the original purchase of the manufacturer or a third party designated maintenance unit.
ErrorSuggestion00350000	No Error
ErrorSuggestion0035F051	[Cause]Robot has detected an overshoot of U phase current on the motor [Caution] 1. Check the header of the error code to see which motor is with this issue 2. Check if the robot is run with payload out of spec and also in high speed 3. Check if the safety settings of the robot [Additional Explanation] If the robot is driven and accelerate fast, current of the motor will overshoot and trigger this error [Additional Explanation] This is usually be triggered when running the robot with a heavy payload with high speed which is nearly or already out of spec. [Additional Explanation] Another reason may be there is dysfunction on the electronics on the motors [Solution] 1. Shut down and reboot the robot 2. Make sure the payload (including the tool) is within the spec. 3. Adjust the speed or movement to prevent the risk of having a single joint accelerate too fast 4. If it still happens, export the Logs, Project and TCP used, and contact to your service engineer
ErrorSuggestion0035F052	[Cause]Robot has detected a overshoot of V phase current on the motor [Caution] 1. Check the header of the error code to see which motor is with this issue



ErrorSuggestion0035F053

2. Check if the robot is run with payload out of spec. and also in high speed
3. Check if the safety settings of the robot

[Additional Explanation] If the robot is driven and accelerate fast, current of the motor will overshoot and trigger this error

[Additional Explanation] This is usually be triggered when running the robot with a heavy payload with high speed which is nearly or already out of spec.

[Additional Explanation] Another reason may be there is dysfunction on the electronics on the motors

[Solution]

1. Shut down and reboot the robot
2. Make sure the payload (including the tool) is within the spec.
3. Adjust the speed or movement to prevent the risk of having a single joint accelerate too fast
4. If it still happens, export the Logs, Project and TCP used, and contact to your service engineer

[Cause]Robot has detected a overshoot of W phase current on the motor

[Caution]

1. Check the header of the error code to see which motor is with this issue
2. Check if the robot is run with payload out of spec. and also in high speed
3. Check if the safety settings of the robot

[Additional Explanation] If the robot is driven and accelerate fast, current of the motor will overshoot and trigger this error

[Additional Explanation] This is usually be triggered when running the robot with a heavy payload with high speed which is nearly or already out of spec.

[Additional Explanation] Another reason may be there is dysfunction on the electronics on the motors

[Solution]

1. Shut down and reboot the robot
2. Make sure the payload (including the tool) is within the spec.
3. Adjust the speed or movement to prevent the risk of having a single joint accelerate too fast
4. If it still happens, export the Logs, Project and TCP used, and contact to your service engineer

ErrorSuggestion0035F054

[Cause]Robot has detected the current on DCBUS went too high suddenly.

[Caution]

1. The speed (ABS/project speed) is too fast.
2. Check whether there is any collision while robot moving.

[Additional Explanations] If robot is moving in a high speed in some movement or pose, it would cause this error. And if robot has collisions, it would cause the current became abnormal.

[Solution][General User]

1. Slow down the speed (ABS/project speed).
2. Avoid any collision while robot is moving.
3. After restart the robot, the problem still occur, contact a qualified service engineer for further analysis.

ErrorSuggestion0035F055

[Cause]

1. Power supply is not stable.
2. Robot moves in high speed, current is higher, voltage loss getting higher.( $V_{input}-V_{loss}=V$  for DC bus)
3. Power connector problem, consume too much power

[Additional Explanation] When robot is working and detects the voltage of DC bus is low, it will report this error

[Solution]

1. Power off the robot
2. Check Robot Cable and its connector before power on again
3. Reduce Robot speed if necessary

Make sure power source is stable

ErrorSuggestion0035F056	<p>[Cause] Robot detect the voltage on DCBUS is higher than spec.</p> <p>[Caution] Check whether there are others error log along with this error.</p> <p>[Additional Explanation] There may be a variety of reasons that cause a high voltage, for example:</p> <ol style="list-style-type: none"> <li>1. The robot move too fast with the current project (with heavy payload)</li> <li>2. Power eater modules is abnormal</li> <li>3. etc.</li> </ol> <p>[Precaution] Power off and unplug the power cable before opening the control box for items checking</p> <p>[Solution]</p> <ol style="list-style-type: none"> <li>1. Make sure the robot would not be collided and be placed on a unstable platform.</li> <li>2. Make sure project speed with payload is within the specification.</li> <li>3. After restart the robot, the problem still occur, contact a qualified service engineer for further analysis</li> </ol>
ErrorSuggestion0035F057	<ol style="list-style-type: none"> <li>1. Please try to restart the robot.</li> <li>2. If the restart is invalid, please contact the original purchase or third-party designated maintenance units.</li> </ol>
ErrorSuggestion0035F058	<p>[Cause] DC to DC component on Join PCB is damaged</p> <p>[Additional Explanation] When detect voltage of 1.65V is abnormal, it will report this error</p> <p>[Solution]</p> <ol style="list-style-type: none"> <li>1. Export the log file</li> <li>2. Contact a qualified service engineer</li> </ol>
ErrorSuggestion0035F059	<p>[Cause] DC to DC component on Join PCB is damaged</p> <p>[Additional Explanation] When detect voltage of 12V is abnormal, it will report this error</p> <p>[Solution]</p> <ol style="list-style-type: none"> <li>1. Export the log file</li> <li>2. Contact a qualified service engineer</li> </ol>
ErrorSuggestion0035F05A	<p>[Cause] DC to DC component on Join PCB is damaged</p> <p>[Additional Explanation] When detect voltage of 6V is abnormal, it will report this error</p> <p>[Solution]</p> <ol style="list-style-type: none"> <li>1. Export the log file</li> <li>2. Contact a qualified service engineer</li> </ol>
ErrorSuggestion0035F05B	<p>[Cause] DC to DC component on Join PCB is damaged</p> <p>[Additional Explanation] When detect voltage of 3.3V is abnormal, it will report this error</p> <p>[Solution]</p> <ol style="list-style-type: none"> <li>1. Export the log file</li> <li>2. Contact a qualified service engineer</li> </ol>
ErrorSuggestion0035F05C	<p>[Cause] DC to DC component on Join PCB is damaged</p> <p>[Additional Explanation] When detect voltage of 1.2V is abnormal, it will report this error</p> <p>[Solution]</p> <ol style="list-style-type: none"> <li>1. Export the log file</li> <li>2. Contact a qualified service engineer</li> </ol>
ErrorSuggestion0035F061	<p>[Cause] The speed command is too large</p> <p>[Solution]</p> <ol style="list-style-type: none"> <li>1. Shut down and reboot the robot</li> <li>2. Reduce the motion speed, check the flow and the speed and posture in each node</li> <li>3. If it still happens, export the Logs, Project and TCP used, and contact to your service engineer</li> </ol>
ErrorSuggestion0035F062	<p>[Cause] The deviation between target and current position is too large</p> <p>[Solution]</p> <ol style="list-style-type: none"> <li>1. Shut down and reboot the robot</li> </ol>

ErrorSuggestion0035F063

2. Reduce the motion speed, check the flow, speed and posture in each node
3. If it still happens, export the Logs, Project and TCP used, and contact to your service engineer

[Cause] The motor output command rises sudden and triggers motor hold protection

[Caution]

1. Check if there robot has collided to the surroundings seriously
2. Check the description of this error code to see which joint it belongs to

[Additional Explanation] When the robot collides to a solid object in a high speed, some of the joints may suffer a great torque on them and this causes the motor current raise rapidly and trigger this error

[Precaution] Do not drive the joint manually when this error occurs, which might damage the joint

[Solution]

1. Shut down and reboot the robot
2. Adjust the payload, safety settings, speed and see if the issue still happens
3. Make sure the payload (including the tool) is within the spec.
4. Adjust the speed or movement to prevent the risk of having a single joint accelerate too fast
5. If it still happens, export the Logs, Project and TCP used, and contact to your service engineer
6. Make sure the robot will not collide with the surroundings during project run

ErrorSuggestion0035F064

[Cause] The motor current rises sudden and triggers motor hold protection

[Caution]

1. Check if there robot has collided to the surroundings seriously
2. Check the description of this error code to see which joint it belongs to

[Additional Explanation] When the robot collides to a solid object in a high speed, some of the joints may suffer a great torque on them and this causes the motor current raise rapidly and trigger this error

[Precaution] Do not drive the joint manually when this error occurs, which might damage the joint

[Solution]

1. Shut down and reboot the robot
2. Adjust the payload, safety settings, speed and see if the issue still happens
3. Make sure the payload (including the tool) is within the spec.
4. Adjust the speed or movement to prevent the risk of having a single joint accelerate too fast
5. If it still happens, export the Logs, Project and TCP used, and contact to your service engineer
6. Make sure the robot will not collide with the surroundings during project run

ErrorSuggestion0035F071

[Cause] Hardware Failure

[Caution]

[Additional Explanation] This error is not likely happens, mostly because of hardware issue

[Solution]

1. Export the Logs
2. Contact a qualified service engineer for further analysis

ErrorSuggestion0035F072

[Cause] Robot detect the temperature on PCB is higher than spec.

[Caution] 1. Check if the environment temperature is higher than the spec. while robot moving.

2. Check the temperature on View->Status

[Additional Explanation] The temperature would rise during robot operating and the work space temperature will affect as well.

[Solution]

1. Make sure the temperature of the working environment is within the specification.
2. Make sure the payload or the project speed is within the specification

ErrorSuggestion0035F073	<p>3. Shut down the robot, and keep it cool for a while before start up again.</p> <p>4. If this issue still occurs, please contact a qualified service engineer for further analysis</p> <p>[Cause] G sensor overload</p> <p>[Caution]</p> <ol style="list-style-type: none"> <li>1. Check if there robot has collided to the surroundings seriously</li> <li>2. Check the description of this error code to see which joint it belongs to</li> </ol> <p>[Solution]</p> <ol style="list-style-type: none"> <li>1. Adjust the payload, safety settings, speed and see if the issue still happens</li> <li>2. Make sure the payload (including the tool) is within the spec.</li> <li>3. Adjust the speed or movement to prevent the risk of having a single joint accelerate too fast</li> <li>4. If it still happens, export the Logs, Project and TCP used, and contact to your service engineer</li> <li>5. Make sure the robot will not collide with the surroundings during project run</li> </ol>
ErrorSuggestion0035F074	<p>[Cause] Hardware Failure</p> <p>[Caution]</p> <p>[Additional Explanation] This error is not likely happens, mostly because of hardware issue</p> <p>[Solution]</p> <ol style="list-style-type: none"> <li>1. Export the Logs</li> <li>2. Contact a qualified service engineer for further analysis</li> </ol>
ErrorSuggestion0035F075	<p>[Cause] Hardware Failure</p> <p>[Caution]</p> <p>[Restriction] Do not drive the joint with or without drive power when this issue happens</p> <p>[Solution]</p> <ol style="list-style-type: none"> <li>1. Export the Logs</li> <li>2. Contact a qualified service engineer for further analysis</li> <li>3. Make sure that the robot does not collide with the surroundings during operation</li> </ol>
ErrorSuggestion0035F0A4	Please contact the original purchase of the manufacturer or a third party designated maintenance unit.
ErrorSuggestion0035F0A5	Please contact the original purchase of the manufacturer or a third party designated maintenance unit.
ErrorSuggestion0035F0A6	Please contact the original purchase of the manufacturer or a third party designated maintenance unit.
ErrorSuggestion0035F111	Please contact the original purchase of the manufacturer or a third party designated maintenance unit.
ErrorSuggestion0035F112	Please contact the original purchase of the manufacturer or a third party designated maintenance unit.
ErrorSuggestion0035F113	Please contact the original purchase of the manufacturer or a third party designated maintenance unit.
ErrorSuggestion0035F114	Please contact the original purchase of the manufacturer or a third party designated maintenance unit.
ErrorSuggestion0035F115	<p>[Cause]Encoder is abnormal</p> <p>[Caution]</p> <p>[Additional Explanation] This error is not likely happens, mostly because of hardware issue</p> <p>[Solution]</p> <ol style="list-style-type: none"> <li>1. Export the log,</li> <li>2. Contact a qualified service engineer for further analysis</li> </ol>
ErrorSuggestion0035F116	<ol style="list-style-type: none"> <li>1. Please try to restart the robot.</li> <li>2. If the restart is invalid, please contact the original purchase or third-party designated maintenance units.</li> </ol>
ErrorSuggestion0035F117	<ol style="list-style-type: none"> <li>1. Please try to restart the robot.</li> <li>2. If the restart is invalid, please contact the original purchase or third-party designated maintenance units.</li> </ol>
ErrorSuggestion0035F118	<ol style="list-style-type: none"> <li>1. Please try to restart the robot.</li> <li>2. If the restart is invalid, please contact the original purchase or third-party designated maintenance units.</li> </ol>
ErrorSuggestion0035F119	<p>[Cause]</p> <ol style="list-style-type: none"> <li>1. Motor is damaged</li> <li>2. Joint PCB is damaged</li> </ol>

	[Caution]
	[Additional Explanation] When the resistance of UVW current of motor is abnormal, it will report this error
	[Solution]
	1. Export the log file
	2. Contact a qualified service engineer
ErrorSuggestion0035F11A	[Cause]Hardware Failure
	[Caution]
	[Additional Explanation] The cables connection of UVW of motor is not correct. Quality issue or the robot may be disassembled abnormally.
	[Solution]
	1. Export the log file
	2. Contact a qualified service engineer
	3. Make sure the robot is not being disassembled illegally
ErrorSuggestion0035F11B	[Cause] Hardware Failure
	[Caution]
	[Restriction] Do not drive the joint with or without drive power when this issue happens
	[Solution]
	1. Export the Logs
	2. Contact a qualified service engineer for further analysis
	3. Make sure that the robot does not collide with the surroundings during operation
ErrorSuggestion0035F121	Please contact the original purchase of the manufacturer or a third party designated maintenance unit.
ErrorSuggestion0035F122	Please contact the original purchase of the manufacturer or a third party designated maintenance unit.
ErrorSuggestion0035F123	Please contact the original purchase of the manufacturer or a third party designated maintenance unit.
ErrorSuggestion0035F124	Please contact the original purchase of the manufacturer or a third party designated maintenance unit.
ErrorSuggestion0035F125	Please contact the original purchase of the manufacturer or a third party designated maintenance unit.
ErrorSuggestion0035F126	Please contact the original purchase of the manufacturer or a third party designated maintenance unit.
ErrorSuggestion0035F127	Please contact the original purchase of the manufacturer or a third party designated maintenance unit.
ErrorSuggestion0035F128	Please contact the original purchase of the manufacturer or a third party designated maintenance unit.
ErrorSuggestion0035F129	[Cause]Encoder is abnormal
	[Caution]
	[Additional Explanation] This error is not likely happens, mostly because of hardware issue
	[Solution]
	1. Export the log,
	2. Contact a qualified service engineer for further analysis
ErrorSuggestion0035F12A	Please contact the original purchase of the manufacturer or a third party designated maintenance unit.
ErrorSuggestion0035F12B	Please contact the original purchase of the manufacturer or a third party designated maintenance unit.
ErrorSuggestion0035F131	1. Please check grounding line is normal or not.
	2. Please contact the original purchase of the manufacturer or a third party designated maintenance unit.
ErrorSuggestion0035F132	Please contact the original purchase of the manufacturer or a third party designated maintenance unit.
ErrorSuggestion0035F133	[Cause]Robot detect a sudden voltage drop on DCBUS.
	[Caution]
	[Additional Explanation] There may be a variety of reasons that cause a low voltage, for example:
	1. The payload and speed may not in the spec.
	2. Power supply is abnormal
	[Precaution] Power off and unplug the power cable before opening the control box for items checking
	[Solution]
	1. Shut down the robot, make sure the power source is stable then power on.

ErrorSuggestion0035F134	<p>2. Make sure the power source is robust for robot running.</p> <p>3. Adjust the payload, safety settings, speed and see if the issue still happens</p> <p>4. Make sure the payload (including the tool) is within the spec.</p> <p>5. Adjust the speed or movement to prevent the risk of having a single joint accelerate too fast</p> <p>6. If it still happens, export the Logs, Project and TCP used, and contact to your service engineer</p> <p>[Cause] The communication time of EtherCAT is timeout</p> <p>[Caution] Check if any external EtherCAT device used has lost connection</p> <p>[Additional Explanation] System will periodic check the EtherCAT communication, if communication timeout, it will report this error.</p> <p>[Solution]</p>
ErrorSuggestion0035F135	<p>Contact a qualified service engineer for further analysis</p> <p>[Cause] Joint movement range is over range during brake release process</p> <p>[Caution] Check if the payload is too that out of specification, including the mass, center of mass, inertia, etc.</p> <p>[Additional Explanation] System will detect the movement range while brake release process, when the value is over expected, it will report this error.</p> <p>[Solution]</p> <ol style="list-style-type: none"> <li>1. Power off the robot</li> <li>2. Remove all payload and restart the robot</li> <li>3. Make sure the payload is within specification (including the center of mass and inertia)</li> <li>4. Make sure there is no unexpected force acting on the robot during brake release process</li> <li>5. If this issue still happens, have a qualified service engineer for further analysis</li> </ol>
ErrorSuggestion0035F136	<p>[Cause] Current for solenoid is over specification during brake release process</p> <p>[Additional Explanation] System will detect the current for solenoid during brake releasing process, when it find the value over specification, it will report this error</p> <p>[Solution]</p> <ol style="list-style-type: none"> <li>1. Please press ESTOP button and release it to resume Robot to see the issue is still occurred or not.</li> <li>2. If this still occurs, contact a qualified service engineer for further analysis</li> </ol>
ErrorSuggestion0035F137	<p>[Cause] Robot detect a low voltage on DCBUS.</p> <p>[Caution]</p> <p>[Additional Explanation] There may be a variety of reasons that cause a low voltage, for example:</p> <ol style="list-style-type: none"> <li>1. The power source is not stable on customer-site</li> <li>2. Power supply is abnormal</li> <li>3. etc.</li> </ol> <p>[Precaution] Power off and unplug the power cable before opening the control box for items checking</p> <p>[Solution]</p> <ol style="list-style-type: none"> <li>1. Shut down the robot, make sure the power source is stable then power on.</li> <li>2. Make sure the power source is robust for robot running.</li> <li>3. If the same issue still occurs, contact a qualified service engineer for further analysis</li> </ol>
ErrorSuggestion0035F138	<p>[Cause] Robot detect the voltage on DCBUS is higher than spec.</p> <p>[Caution] Check whether there are others error log along with this error.</p> <p>[Additional Explanation] There may be a variety of reasons that cause a high voltage, for example:</p> <ol style="list-style-type: none"> <li>1. The robot move too fast with the current project (with heavy payload)</li> <li>2. Power eater modules is abnormal</li> <li>3. etc.</li> </ol> <p>[Precaution] Power off and unplug the power cable before opening the control box for items checking</p> <p>[Solution]</p> <ol style="list-style-type: none"> <li>1. Make sure the robot would not be collided and be placed on a unstable platform.</li> </ol>

ErrorSuggestion0035F139	<p>2. Make sure project speed with payload is within the specification.</p> <p>3. After restart the robot, the problem still occur, contact a qualified service engineer for further analysis</p> <p>[Cause] Robot detect a sudden voltage drop on DCBUS.</p> <p>[Caution]</p> <p>[Additional Explanation] There may be a variety of reasons that cause a low voltage, for example:</p> <ol style="list-style-type: none"> <li>1. The payload and speed may not in the spec.</li> <li>2. Power supply is abnormal</li> </ol> <p>[Precaution] Power off and unplug the power cable before opening the control box for items checking</p> <p>[Solution]</p> <ol style="list-style-type: none"> <li>1. Shut down the robot, make sure the power source is stable then power on.</li> <li>2. Make sure the power source is robust for robot running.</li> <li>3. Adjust the payload, safety settings, speed and see if the issue still happens</li> <li>4. Make sure the payload (including the tool) is within the spec.</li> <li>5. Adjust the speed or movement to prevent the risk of having a single joint accelerate too fast</li> <li>6. If it still happens, export the Logs, Project and TCP used, and contact to your service engineer</li> </ol>
ErrorSuggestion0035F141	<ol style="list-style-type: none"> <li>1. Please try to restart the robot.</li> <li>2. If the restart is invalid, please contact the original purchase or third-party designated maintenance units.</li> </ol>
ErrorSuggestion0035F142	<ol style="list-style-type: none"> <li>1. Please try to restart the robot.</li> <li>2. If the restart is invalid, please contact the original purchase or third-party designated maintenance units.</li> </ol>
ErrorSuggestion0035F143	<ol style="list-style-type: none"> <li>1. Please try to restart the robot.</li> <li>2. If the restart is invalid, please contact the original purchase or third-party designated maintenance units.</li> </ol>
ErrorSuggestion0035F144	<ol style="list-style-type: none"> <li>1. Please try to restart the robot.</li> <li>2. If the restart is invalid, please contact the original purchase or third-party designated maintenance units.</li> </ol>
ErrorSuggestion0035F145	<p>[Cause] Encoder is dysfunctional</p> <p>[Caution]</p> <p>[Additional Explanation] This error is not likely happens, mostly because of hardware issue</p> <p>[Solution]</p> <ol style="list-style-type: none"> <li>1. Export the Logs</li> <li>2. Contact a qualified service engineer for further analysis</li> </ol>
ErrorSuggestion0035F146	<p>[Cause] Encoder is dysfunctional</p> <p>[Caution]</p> <p>[Additional Explanation] This error is not likely happens, mostly because of hardware issue</p> <p>[Solution]</p> <ol style="list-style-type: none"> <li>1. Export the Logs</li> <li>2. Contact a qualified service engineer for further analysis</li> </ol>
ErrorSuggestion0035F147	<p>[Cause] Encoder is dysfunctional</p> <p>[Caution]</p> <p>[Additional Explanation] This error is not likely happens, mostly because of hardware issue</p> <p>[Solution]</p> <ol style="list-style-type: none"> <li>1. Export the Logs</li> <li>2. Contact a qualified service engineer for further analysis</li> </ol>
ErrorSuggestion0035F148	<p>[Cause] Encoder is dysfunctional</p> <p>[Caution]</p> <p>[Additional Explanation] This error is not likely happens, mostly because of hardware issue</p> <p>[Solution]</p> <ol style="list-style-type: none"> <li>1. Export the Logs</li> <li>2. Contact a qualified service engineer for further analysis</li> </ol>



ErrorSuggestion0035F149	<ol style="list-style-type: none"> <li>1. Please try to restart the robot.</li> <li>2. If the restart is invalid, please contact the original purchase or third-party designated maintenance units.</li> </ol>
ErrorSuggestion0035F1A1	<ol style="list-style-type: none"> <li>1. Please try to restart the robot.</li> <li>2. If the restart is invalid, please contact the original purchase or third-party designated maintenance units.</li> </ol>
ErrorSuggestion0035F1A2	<ol style="list-style-type: none"> <li>1. Please try to restart the robot.</li> <li>2. If the restart is invalid, please contact the original purchase or third-party designated maintenance units.</li> </ol>
ErrorSuggestion0035F1A3	<ol style="list-style-type: none"> <li>1. Please try to restart the robot.</li> <li>2. If the restart is invalid, please contact the original purchase or third-party designated maintenance units.</li> </ol>
ErrorSuggestion0035FF20	<p>[Cause] Current for solenoid is over specification during brake release process</p> <p>[Additional Explanation] System will detect the current for solenoid during brake releasing process, when it find the value over specification, it will report this error</p> <p>[Solution]</p> <ol style="list-style-type: none"> <li>1. Please press ESTOP button and release it to resume Robot to see the issue is still occurred or not.</li> <li>2. If this still occurs, contact a qualified service engineer for further analysis</li> </ol>
ErrorSuggestion0035FF21	<p>[Cause]Joint movement range is over range during brake release process</p> <p>[Caution]Check if the payload is too that out of specification, including the mass, center of mass, inertia, etc.</p> <p>[Additional Explanation] System will detect the movement range while brake release process, when the value is over expected, it will report this error.</p> <p>[Solution]</p> <ol style="list-style-type: none"> <li>1. Power off the robot</li> <li>2. Remove all payload and restart the robot</li> <li>3. Make sure the payload is within specification (including the center of mass and inertia)</li> <li>4. Make sure there is no unexpected force acting on the robot during brake release process</li> <li>5. If this issue still happens, have a qualified service engineer for further analysis</li> </ol>
ErrorSuggestion0035FFA0	<p>[Cause]Robot detect a low voltage on DCBUS.</p> <p>[Caution]Check if the payload is too that out of specification, including the mass, center of mass, inertia, etc.</p> <p>[Additional Explanation] There may be a variety of reasons that cause a low voltage, for example:</p> <ol style="list-style-type: none"> <li>1. The power source is not stable on customer-site</li> <li>2. Power supply is abnormal</li> <li>3. etc.</li> </ol> <p>[Precaution] Power off and unplug the power cable before opening the control box for items checking</p> <p>[Solution]</p> <p>Shut down the robot, make sure the power source is stable then power on. If the same issue still occurs, contact a qualified service engineer for further analysis</p> <p>Make sure the power source is robust for robot running.</p>
ErrorSuggestion0035FFA1	<p>[Cause]Robot detect the voltage on DCBUS is higher than spec.</p> <p>[Caution]Check whether there are others error log along with this error.</p> <p>[Additional Explanation] There may be a variety of reasons that cause a high voltage, for example:</p> <ol style="list-style-type: none"> <li>1. The robot move too fast with the current project (with heavy payload)</li> <li>2. Power eater modules is abnormal</li> <li>3. etc.</li> </ol> <p>[Precaution] Power off and unplug the power cable before opening the control box for items checking</p> <p>[Solution]</p> <p>After restart the robot, the problem still occur, contact a qualified service engineer for further analysis</p> <ol style="list-style-type: none"> <li>1. Make sure the robot would not be collided and be placed on a unstable platform.</li> <li>2. Make sure project speed with payload is within the specification.</li> </ol>
ErrorSuggestion0035FFA2	<p>Be careful! G sensor overload on X direction.</p>



ErrorSuggestion0035FFA3	Be careful! G sensor overload on Y direction.
ErrorSuggestion0035FFA4	Be careful! G sensor overload on Z direction.
ErrorSuggestion0035FFA5	<p>[Cause]Robot detect the temperature on PCB is higher than spec.</p> <p>[Caution]1. Check if the environment temperature is higher than the spec. while robot moving. 2. Check the temperature on View-&gt;Status</p> <p>[Additional Explanation] The temperature would rise during robot operating and the work space temperature will affect as well.</p> <p>[Solution] Shut down the robot, and keep it cool for a while before start up again. If this issue still occurs, please contact a qualified service engineer for further analysis</p> <ol style="list-style-type: none"> <li>1. Make sure the temperature of the working environment is within the specification.</li> <li>2. Make sure the payload or the project speed is within the specification</li> </ol>
ErrorSuggestion0035FFA6	<p>[Cause]Robot has detected an overshoot of U phase current on the motor</p> <p>[Caution]</p> <ol style="list-style-type: none"> <li>1. Check the header of the error code to see which motor is with this issue</li> <li>2. Check if the robot is run with payload out of spec. and also in high speed</li> <li>3. Check if the safety settings of the robot</li> </ol> <p>[Additional Explanation] If the robot is driven and accelerate fast, current of the motor will overshoot and trigger this error</p> <p>[Additional Explanation] This is usually be triggered when running the robot with a heavy payload with high speed which is nearly or already out of spec.</p> <p>[Additional Explanation] Another reason may be there is dysfunction on the electronics on the motors</p> <p>[Solution]</p> <ol style="list-style-type: none"> <li>1. Shut down and reboot the robot</li> <li>2. Adjust the payload, safety settings, speed and see if the issue still happens</li> <li>3. Make sure the payload (including the tool) is within the spec.</li> <li>4. Adjust the speed or movement to prevent the risk of having a single joint accelerate too fast</li> <li>5. If it still happens, export the Logs, Project and TCP used, and contact to your service engineer</li> </ol>
ErrorSuggestion0035FFA7	<p>[Cause]Robot has detected a overshoot of V phase current on the motor</p> <p>[Caution]</p> <ol style="list-style-type: none"> <li>1. Check the header of the error code to see which motor is with this issue</li> <li>2. Check if the robot is run with payload out of spec. and also in high speed</li> <li>3. Check if the safety settings of the robot</li> </ol> <p>[Additional Explanation] If the robot is driven and accelerate fast, current of the motor will overshoot and trigger this error</p> <p>[Additional Explanation] This is usually be triggered when running the robot with a heavy payload with high speed which is nearly or already out of spec.</p> <p>[Additional Explanation] Another reason may be there is dysfunction on the electronics on the motors</p> <p>[Solution]</p> <ol style="list-style-type: none"> <li>1. Shut down and reboot the robot</li> <li>2. Adjust the payload, safety settings, speed and see if the issue still happens</li> <li>3. Make sure the payload (including the tool) is within the spec.</li> <li>4. Adjust the speed or movement to prevent the risk of having a single joint accelerate too fast</li> <li>5. If it still happens, export the Logs, Project and TCP used, and contact to your service engineer</li> </ol>
ErrorSuggestion0035FFA8	<p>[Cause]Robot has detected a overshoot of W phase current on the motor</p> <p>[Caution]</p> <ol style="list-style-type: none"> <li>1. Check the header of the error code to see which motor is with this issue</li> </ol>

ErrorSuggestion0035FFA9  
ErrorSuggestion0035FFAA  
ErrorSuggestion0035FFAB

2. Check if the robot is run with payload out of spec. and also in high speed
3. Check if the safety settings of the robot

[Additional Explanation] If the robot is driven and accelerate fast, current of the motor will overshoot and trigger this error

[Additional Explanation] This is usually be triggered when running the robot with a heavy payload with high speed which is nearly or already out of spec.

[Additional Explanation] Another reason may be there is dysfunction on the electronics on the motors

[Solution]

1. Shut down and reboot the robot
2. Adjust the payload, safety settings, speed and see if the issue still happens
3. Make sure the payload (including the tool) is within the spec.
4. Adjust the speed or movement to prevent the risk of having a single joint accelerate too fast
5. If it still happens, export the Logs, Project and TCP used, and contact to your service engineer

Be careful! Motor current protection on U phase triggered, which may be caused by impact.

Be careful! Motor current protection on V phase triggered, which may be caused by impact.

[Cause]The motor current rises sudden and triggers motor hold protection

[Caution]

1. Check if there robot has collided to the surroundings seriously
2. Check the description of this error code to see which joint it belongs to

[Additional Explanation] When the robot collides to a solid object in a high speed, some of the joints may suffer a great torque on them and this causes the motor current raise rapidly and trigger this error

[Precaution] Do not drive the joint manually when this error occurs, which might damage the joint

[Solution]

1. Shut down and reboot the robot
2. Adjust the payload, safety settings, speed and see if the issue still happens
3. Make sure the payload (including the tool) is within the spec.
4. Adjust the speed or movement to prevent the risk of having a single joint accelerate too fast
5. If it still happens, export the Logs, Project and TCP used, and contact to your service engineer
6. Make sure the robot will not collide with the surroundings during project run

a error occurred in the UVW signal on optical encoder

The index of encoder is not calibrated.

[Cause]Robot has detected the current on DCBUS went too high suddenly.

[Caution]

1. The speed(ABS/project speed) is too fast.
2. Check whether there is any collision while robot moving.

[Additional Explanations] If robot is moving in a high speed in some movement or pose, it would cause this error. And if robot has collisions, it would cause the current became abnormal.

[Solution][General User]

1. Slow down the speed(ABS/project speed).
2. Avoid any collision while robot is moving.
3. After restart the robot, the problem still occur, contact a qualified service engineer for further analysis.

ErrorSuggestion0035FFAF

[Cause] The communication time of EtherCAT is timeout

[Caution] Check if any external EtherCAT device used has lost connection

[Additional Explanation] System will periodic check the EtherCAT communication, if communication timeout, it will report this error.

	[Solution] Contact a qualified service engineer for further analysis
ErrorSuggestion0035FFB1	[Cause] The communication time of SPI is timeout [Caution] [Additional Explanation] It may possibly because the SPI IC is dysfunction which is not likely to happen [Solution] Contact a qualified service engineer for further analysis
ErrorSuggestion0035FFB2	1. Please check grounding line is normal or not. 2. Please contact the original purchase of the manufacturer or a third party designated maintenance unit.
ErrorSuggestion0035FFB3	Please contact the original purchase of the manufacturer or a third party designated maintenance unit.
ErrorSuggestion0035FFB4	1. Please try to restart the robot. 2. If the restart is invalid, please contact the original purchase or third-party designated maintenance units.
ErrorSuggestion0035FFB5	1. Please try to restart the robot. 2. If the restart is invalid, please contact the original purchase or third-party designated maintenance units.
ErrorSuggestion0035FFB6	Please contact the original purchase of the manufacturer or a third party designated maintenance unit.
ErrorSuggestion0035FFB7	Please check the functionality of break unit
ErrorSuggestion0035FFB8	[Cause] Hardware Failure [Caution] [Additional Explanation] This error is not likely happens, mostly because of hardware issue [Solution] 1. Export the Logs 2. Contact a qualified service engineer for further analysis
ErrorSuggestion0035FFB9	[Cause] Hardware Failure [Caution] [Additional Explanation] This error is not likely happens, mostly because of hardware issue [Solution] 1. Export the Logs 2. Contact a qualified service engineer for further analysis
ErrorSuggestion0035FFBA	[Cause] Hardware Failure [Caution] [Restriction] Do not pull the joint forcibly when the problem occurs, so as not to cause damage to the joint [Solution] 1. Export the Logs 2. Contact a qualified service engineer for further analysis 3. Make sure that the robot does not collide with the surroundings during operation
ErrorSuggestion0035FFC0	a error occurred in transit to absolute position
ErrorSuggestion0035FFC1	Please contact the original purchase of the manufacturer or a third party designated maintenance unit.
ErrorSuggestion0035FFC2	Please contact the original purchase of the manufacturer or a third party designated maintenance unit.
ErrorSuggestion0035FFC3	Please contact the original purchase of the manufacturer or a third party designated maintenance unit.
ErrorSuggestion0035FFC4	Please contact the original purchase of the manufacturer or a third party designated maintenance unit.
ErrorSuggestion0035FFC5	Please contact the original purchase of the manufacturer or a third party designated maintenance unit.
ErrorSuggestion0035FFC6	Please contact the original purchase of the manufacturer or a third party designated maintenance unit.
ErrorSuggestion0035FFC7	Please contact the original purchase of the manufacturer or a third party designated maintenance unit.
ErrorSuggestion0035FFC8	Please contact the original purchase of the manufacturer or a third party designated maintenance unit.
ErrorSuggestion0035FFC9	Please contact the original purchase of the manufacturer or a third party designated maintenance unit.
ErrorSuggestion0035FFCA	[Cause] Encoder is dysfunctional [Caution]

ErrorSuggestion0035FFCB ErrorSuggestion0035FFCC	<p>[Additional Explanation] This error is not likely happens, mostly because of hardware issue</p> <p>[Solution]</p> <ol style="list-style-type: none"> <li>1. Export the Logs</li> <li>2. Contact a qualified service engineer for further analysis</li> </ol> <p>Please reduce the motion speed, check the flow and the speed and posture in each node</p> <p>[Cause] Encoder is dysfunctional</p> <p>[Caution]</p>
ErrorSuggestion0035FFCD	<p>[Additional Explanation] This error is not likely happens, mostly because of hardware issue</p> <p>[Solution]</p> <ol style="list-style-type: none"> <li>1. Export the Logs</li> <li>2. Contact a qualified service engineer for further analysis</li> </ol> <p>[Cause] Hardware Failure</p> <p>[Caution]</p>
ErrorSuggestion0035FFCE	<p>[Restriction] Do not drive the joint with or without drive power when this issue happens</p> <p>[Solution]</p> <ol style="list-style-type: none"> <li>1. Export the Logs</li> <li>2. Contact a qualified service engineer for further analysis</li> <li>3. Make sure that the robot does not collide with the surroundings during operation</li> </ol> <p>[Cause] Hardware Failure</p> <p>[Caution]</p>
ErrorSuggestion0035FFCF	<p>[Restriction] Do not drive the joint with or without drive power</p> <p>[Solution]</p> <ol style="list-style-type: none"> <li>1. Export the Logs</li> <li>2. Contact a qualified service engineer for further analysis</li> </ol> <p>[Cause] The motor current rises sudden and triggers motor hold protection</p> <p>[Caution]</p> <ol style="list-style-type: none"> <li>1. Check if there robot has collided to the surroundings seriously</li> <li>2. Check the description of this error code to see which joint it belongs to</li> </ol> <p>[Additional Explanation] When the robot collides to a solid object in a high speed, some of the joints may suffer a great torque on them and this causes the motor current raise rapidly and trigger this error</p>
ErrorSuggestion0035FFD0 ErrorSuggestion0035FFD1	<p>[Precaution] Do not drive the joint manually when this error occurs, which might damage the joint</p> <p>[Solution]</p> <ol style="list-style-type: none"> <li>1. Shut down and reboot the robot</li> <li>2. Adjust the payload, safety settings, speed and see if the issue still happens</li> <li>3. Make sure the payload (including the tool) is within the spec.</li> <li>4. Adjust the speed or movement to prevent the risk of having a single joint accelerate too fast</li> <li>5. If it still happens, export the Logs, Project and TCP used, and contact to your service engineer</li> <li>6. Make sure the robot will not collide with the surroundings during project run</li> </ol> <p>Please check the UVW signal on encoder</p> <p>[Cause] Hardware Failure</p> <p>[Caution] Check if the robot is placed near any device with strong magnetic field</p> <p>[Additional Explanation] Under a strong magnetic field may affect the readings of the magnetic encoder</p> <p>[Solution]</p> <ol style="list-style-type: none"> <li>1. Export the Logs</li> <li>2. Make sure the robot is not under any strong magnetic field and then reboot the robot</li> <li>3. If this still does not work, Contact a qualified service engineer for further analysis</li> </ol>

ErrorSuggestion0035FFD2	<p>[Cause] Hardware Failure</p> <p>[Caution] Check if the robot is placed near any device with strong magnetic field</p> <p>[Additional Explanation] Under a strong magnetic field may affect the readings of the magnetic encoder</p> <p>[Solution]</p> <ol style="list-style-type: none"> <li>1. Export the Logs</li> <li>2. Make sure the robot is not under any strong magnetic field and then reboot the robot</li> <li>3. If this still does not work, Contact a qualified service engineer for further analysis</li> </ol>
ErrorSuggestion0035FFD3	<p>[Cause]</p> <ol style="list-style-type: none"> <li>1. The robot may be disassembled abnormally. Please check the warranty sticker and thread-locking fluid are both broken or not</li> <li>2. Joint gear wear out</li> </ol> <p>[Caution]</p> <p>[Additional Explanation] When the origin of joint module is not detected, it will report this error</p> <p>[Solution]</p> <ol style="list-style-type: none"> <li>1. Export the Logs</li> <li>2. Contact a qualified service engineer for further analysis</li> </ol>
ErrorSuggestion0035FFD4	Please contact the original purchase of the manufacturer or a third party designated maintenance unit.
ErrorSuggestion0035FFD5	Please contact the original purchase of the manufacturer or a third party designated maintenance unit.
ErrorSuggestion0035FFD6	Please contact the original purchase of the manufacturer or a third party designated maintenance unit.
ErrorSuggestion0035FFD7	Please contact the original purchase of the manufacturer or a third party designated maintenance unit.
ErrorSuggestion0035FFD8	<p>[Cause]</p> <ol style="list-style-type: none"> <li>1. Motor is damaged</li> <li>2. Joint PCB is damaged</li> </ol> <p>[Additional Explanation] When the resistance of UVW current of motor is abnormal, it will report this error</p> <p>[Solution]</p> <ol style="list-style-type: none"> <li>1. Export the log file</li> <li>2. Contact a qualified service engineer</li> </ol>
ErrorSuggestion0035FFD9	<p>[Cause] Hardware Failure</p> <p>[Additional Explanation] The cables connection of UVW of motor is not correct. Quality issue or the robot may be disassembled abnormally.</p> <p>[Solution]</p> <ol style="list-style-type: none"> <li>1. Export the log file</li> <li>2. Contact a qualified service engineer</li> <li>3. Make sure the robot is not being disassembled illegally</li> </ol>
ErrorSuggestion0035FFDA	Please contact the original purchase of the manufacturer or a third party designated maintenance unit.
ErrorSuggestion0035FFDB	Please contact the original purchase of the manufacturer or a third party designated maintenance unit.
ErrorSuggestion0035FFDC	Please contact the original purchase of the manufacturer or a third party designated maintenance unit.
ErrorSuggestion0035FFDD	<ol style="list-style-type: none"> <li>1. Please restart the robot.</li> <li>2. If the restart is invalid, please contact the original purchase or third-party designated maintenance units.</li> </ol>
ErrorSuggestion0035FFDE	<ol style="list-style-type: none"> <li>1. Please restart the robot.</li> <li>2. If the restart is invalid, please contact the original purchase or third-party designated maintenance units.</li> </ol>
ErrorSuggestion0035FFDF	<ol style="list-style-type: none"> <li>1. Please restart the robot.</li> <li>2. If the restart is invalid, please contact the original purchase or third-party designated maintenance units.</li> </ol>
ErrorSuggestion0035FFE0	<p>[Cause]</p> <ol style="list-style-type: none"> <li>1. Power supply is not stable.</li> <li>2. Robot moves in high speed, current is higher, voltage loss getting higher. (<math>V_{input} - V_{loss} = V</math> for DC bus)</li> <li>3. Power connector problem, consume too much power</li> </ol>

	[Additional Explanation] When robot is working and detects the voltage of DC bus is low, it will report this error
	[Solution]
	1. Power off the robot
	2. Check Robot Cable and its connector before power on again
	3. Reduce Robot speed if necessary
	Make sure power source is stable
ErrorSuggestion0035FFE1	Please contact the original purchase of the manufacturer or a third party designated maintenance unit.
ErrorSuggestion0035FFE2	1. Please restart the robot.
	2. If the restart is invalid, please contact the original purchase or third-party designated maintenance units.
ErrorSuggestion0035FFE3	1. Please restart the robot.
	2. If the restart is invalid, please contact the original purchase or third-party designated maintenance units.
ErrorSuggestion0035FFE4	[Cause] Encoder is abnormal
	[Additional Explanation] This error is not likely happens, mostly because of hardware issue
	[Solution]
	1. Export the log file
	2. Contact a qualified service engineer
ErrorSuggestion0035FFE5	1. Please restart the robot.
	2. If the restart is invalid, please contact the original purchase or third-party designated maintenance units.
ErrorSuggestion0035FFE6	1. Please restart the robot.
	2. If the restart is invalid, please contact the original purchase or third-party designated maintenance units.
ErrorSuggestion0035FFE7	Please contact the original purchase of the manufacturer or a third party designated maintenance unit.
ErrorSuggestion0035FFE8	[Cause]Hardware Failure
	[Additional Explanation] When the output of the G sensor is abnormal, it will report this error
	[Solution]
	1. Export the log file
	2. Contact a qualified service engineer
ErrorSuggestion0035FFE9	Please contact the original purchase of the manufacturer or a third party designated maintenance unit.
ErrorSuggestion0035FFEA	[Cause] DC to DC component on Join PCB is damaged
	[Additional Explanation] When detect voltage of 5V is abnormal, it will report this error
	[Solution]
	1. Export the log file
	2. Contact a qualified service engineer
ErrorSuggestion0035FFEB	[Cause] DC to DC component on Join PCB is damaged
	[Additional Explanation] When detect voltage of 12V is abnormal, it will report this error
	[Solution]
	1. Export the log file
	2. Contact a qualified service engineer
ErrorSuggestion0035FFEC	Please contact the original purchase of the manufacturer or a third party designated maintenance unit.
ErrorSuggestion0035FFED	[Cause] Encoder abnormal
	[Additional Explanation] This error is not likely happens, mostly because of hardware issue
	[Solution]
	[Solution]
	1. Export the log file
	2. Contact a qualified service engineer
ErrorSuggestion0035FFEE	Please turn on joint modules
ErrorSuggestion0035FFEF	Please contact the original purchase of the manufacturer or a third party designated maintenance unit.
ErrorSuggestion00450000	No Error

ErrorSuggestion0045F051	<p>[Cause]Robot has detected an overshoot of U phase current on the motor</p> <p>[Caution]</p> <ol style="list-style-type: none"> <li>1. Check the header of the error code to see which motor is with this issue</li> <li>2. Check if the robot is run with payload out of spec and also in high speed</li> <li>3. Check if the safety settings of the robot</li> </ol> <p>[Additional Explanation] If the robot is driven and accelerate fast, current of the motor will overshoot and trigger this error</p> <p>[Additional Explanation] This is usually be triggered when running the robot with a heavy payload with high speed which is nearly or already out of spec.</p> <p>[Additional Explanation] Another reason may be there is dysfunction on the electronics on the motors</p> <p>[Solution]</p> <ol style="list-style-type: none"> <li>1. Shut down and reboot the robot</li> <li>2. Make sure the payload (including the tool) is within the spec.</li> <li>3. Adjust the speed or movement to prevent the risk of having a single joint accelerate too fast</li> <li>4. If it still happens, export the Logs, Project and TCP used, and contact to your service engineer</li> </ol>
ErrorSuggestion0045F052	<p>[Cause]Robot has detected a overshoot of V phase current on the motor</p> <p>[Caution]</p> <ol style="list-style-type: none"> <li>1. Check the header of the error code to see which motor is with this issue</li> <li>2. Check if the robot is run with payload out of spec. and also in high speed</li> <li>3. Check if the safety settings of the robot</li> </ol> <p>[Additional Explanation] If the robot is driven and accelerate fast, current of the motor will overshoot and trigger this error</p> <p>[Additional Explanation] This is usually be triggered when running the robot with a heavy payload with high speed which is nearly or already out of spec.</p> <p>[Additional Explanation] Another reason may be there is dysfunction on the electronics on the motors</p> <p>[Solution]</p> <ol style="list-style-type: none"> <li>1. Shut down and reboot the robot</li> <li>2. Make sure the payload (including the tool) is within the spec.</li> <li>3. Adjust the speed or movement to prevent the risk of having a single joint accelerate too fast</li> <li>4. If it still happens, export the Logs, Project and TCP used, and contact to your service engineer</li> </ol>
ErrorSuggestion0045F053	<p>[Cause]Robot has detected a overshoot of W phase current on the motor</p> <p>[Caution]</p> <ol style="list-style-type: none"> <li>1. Check the header of the error code to see which motor is with this issue</li> <li>2. Check if the robot is run with payload out of spec. and also in high speed</li> <li>3. Check if the safety settings of the robot</li> </ol> <p>[Additional Explanation] If the robot is driven and accelerate fast, current of the motor will overshoot and trigger this error</p> <p>[Additional Explanation] This is usually be triggered when running the robot with a heavy payload with high speed which is nearly or already out of spec.</p> <p>[Additional Explanation] Another reason may be there is dysfunction on the electronics on the motors</p> <p>[Solution]</p> <ol style="list-style-type: none"> <li>1. Shut down and reboot the robot</li> <li>2. Make sure the payload (including the tool) is within the spec.</li> <li>3. Adjust the speed or movement to prevent the risk of having a single joint accelerate too fast</li> <li>4. If it still happens, export the Logs, Project and TCP used, and contact to your service engineer</li> </ol>
ErrorSuggestion0045F054	<p>[Cause]Robot has detected the current on DCBUS went too high suddenly.</p> <p>[Caution]</p>



ErrorSuggestion0045F055	<p>1. The speed (ABS/project speed) is too fast.</p> <p>2. Check whether there is any collision while robot moving.</p> <p>[Additional Explanations] If robot is moving in a high speed in some movement or pose, it would cause this error. And if robot has collisions, it would cause the current became abnormal.</p> <p>[Solution][General User]</p> <ol style="list-style-type: none"> <li>1. Slow down the speed (ABS/project speed).</li> <li>2. Avoid any collision while robot is moving.</li> <li>3. After restart the robot, the problem still occur, contact a qualified service engineer for further analysis.</li> </ol> <p>[Cause]</p> <ol style="list-style-type: none"> <li>1. Power supply is not stable.</li> <li>2. Robot moves in high speed, current is higher, voltage loss getting higher.(Vinput-Vloss=V for DC bus)</li> <li>3. Power connector problem, consume too much power</li> </ol> <p>[Additional Explanation] When robot is working and detects the voltage of DC bus is low, it will report this error</p> <p>[Solution]</p> <ol style="list-style-type: none"> <li>1. Power off the robot</li> <li>2. Check Robot Cable and its connector before power on again</li> <li>3. Reduce Robot speed if necessary</li> </ol> <p>Make sure power source is stable</p>
ErrorSuggestion0045F056	<p>[Cause]Robot detect the voltage on DCBUS is higher than spec.</p> <p>[Caution]Check whether there are others error log along with this error.</p> <p>[Additional Explanation] There may be a variety of reasons that cause a high voltage, for example:</p> <ol style="list-style-type: none"> <li>1. The robot move too fast with the current project (with heavy payload)</li> <li>2. Power eater modules is abnormal</li> <li>3. etc.</li> </ol> <p>[Precaution] Power off and unplug the power cable before opening the control box for items checking</p> <p>[Solution]</p> <ol style="list-style-type: none"> <li>1. Make sure the robot would not be collided and be placed on a unstable platform.</li> <li>2. Make sure project speed with payload is within the specification.</li> <li>3. After restart the robot, the problem still occur, contact a qualified service engineer for further analysis</li> </ol>
ErrorSuggestion0045F057	<ol style="list-style-type: none"> <li>1. Please try to restart the robot.</li> <li>2. If the restart is invalid, please contact the original purchase or third-party designated maintenance units.</li> </ol>
ErrorSuggestion0045F058	<p>[Cause] DC to DC component on Join PCB is damaged</p> <p>[Additional Explanation] When detect voltage of 1.65V is abnormal, it will report this error</p> <p>[Solution]</p> <ol style="list-style-type: none"> <li>1. Export the log file</li> <li>2. Contact a qualified service engineer</li> </ol>
ErrorSuggestion0045F059	<p>[Cause] DC to DC component on Join PCB is damaged</p> <p>[Additional Explanation] When detect voltage of 12V is abnormal, it will report this error</p> <p>[Solution]</p> <ol style="list-style-type: none"> <li>1. Export the log file</li> <li>2. Contact a qualified service engineer</li> </ol>
ErrorSuggestion0045F05A	<p>[Cause] DC to DC component on Join PCB is damaged</p> <p>[Additional Explanation] When detect voltage of 6V is abnormal, it will report this error</p> <p>[Solution]</p> <ol style="list-style-type: none"> <li>1. Export the log file</li> <li>2. Contact a qualified service engineer</li> </ol>



ErrorSuggestion0045F05B	<p>[Cause] DC to DC component on Join PCB is damaged</p> <p>[Additional Explanation] When detect voltage of 3.3V is abnormal, it will report this error</p> <p>[Solution]</p> <ol style="list-style-type: none"> <li>1. Export the log file</li> <li>2. Contact a qualified service engineer</li> </ol>
ErrorSuggestion0045F05C	<p>[Cause] DC to DC component on Join PCB is damaged</p> <p>[Additional Explanation] When detect voltage of 1.2V is abnormal, it will report this error</p> <p>[Solution]</p> <ol style="list-style-type: none"> <li>1. Export the log file</li> <li>2. Contact a qualified service engineer</li> </ol>
ErrorSuggestion0045F061	<p>[Cause] The speed command is too large</p> <p>[Solution]</p> <ol style="list-style-type: none"> <li>1. Shut down and reboot the robot</li> <li>2. Reduce the motion speed, check the flow and the speed and posture in each node</li> <li>3. If it still happens, export the Logs, Project and TCP used, and contact to your service engineer</li> </ol>
ErrorSuggestion0045F062	<p>[Cause] The deviation between target and current position is too large</p> <p>[Solution]</p> <ol style="list-style-type: none"> <li>1. Shut down and reboot the robot</li> <li>2. Reduce the motion speed, check the flow, speed and posture in each node</li> <li>3. If it still happens, export the Logs, Project and TCP used, and contact to your service engineer</li> </ol>
ErrorSuggestion0045F063	<p>[Cause] The motor output command rises sudden and triggers motor hold protection</p> <p>[Caution]</p> <ol style="list-style-type: none"> <li>1. Check if there robot has collided to the surroundings seriously</li> <li>2. Check the description of this error code to see which joint it belongs to</li> </ol> <p>[Additional Explanation] When the robot collides to a solid object in a high speed, some of the joints may suffer a great torque on them and this causes the motor current raise rapidly and trigger this error</p> <p>[Precaution] Do not drive the joint manually when this error occurs, which might damage the joint</p> <p>[Solution]</p> <ol style="list-style-type: none"> <li>1. Shut down and reboot the robot</li> <li>2. Adjust the payload, safety settings, speed and see if the issue still happens</li> <li>3. Make sure the payload (including the tool) is within the spec.</li> <li>4. Adjust the speed or movement to prevent the risk of having a single joint accelerate too fast</li> <li>5. If it still happens, export the Logs, Project and TCP used, and contact to your service engineer</li> <li>6. Make sure the robot will not collide with the surroundings during project run</li> </ol>
ErrorSuggestion0045F064	<p>[Cause] The motor current rises sudden and triggers motor hold protection</p> <p>[Caution]</p> <ol style="list-style-type: none"> <li>1. Check if there robot has collided to the surroundings seriously</li> <li>2. Check the description of this error code to see which joint it belongs to</li> </ol> <p>[Additional Explanation] When the robot collides to a solid object in a high speed, some of the joints may suffer a great torque on them and this causes the motor current raise rapidly and trigger this error</p> <p>[Precaution] Do not drive the joint manually when this error occurs, which might damage the joint</p> <p>[Solution]</p> <ol style="list-style-type: none"> <li>1. Shut down and reboot the robot</li> <li>2. Adjust the payload, safety settings, speed and see if the issue still happens</li> <li>3. Make sure the payload (including the tool) is within the spec.</li> </ol>

	<p>4. Adjust the speed or movement to prevent the risk of having a single joint accelerate too fast</p> <p>5. If it still happens, export the Logs, Project and TCP used, and contact to your service engineer</p> <p>6. Make sure the robot will not collide with the surroundings during project run</p>
ErrorSuggestion0045F071	<p>[Cause] Hardware Failure</p> <p>[Caution]</p> <p>[Additional Explanation] This error is not likely happens, mostly because of hardware issue</p> <p>[Solution]</p> <ol style="list-style-type: none"> <li>1. Export the Logs</li> <li>2. Contact a qualified service engineer for further analysis</li> </ol>
ErrorSuggestion0045F072	<p>[Cause] Robot detect the temperature on PCB is higher than spec.</p> <p>[Caution] 1. Check if the environment temperature is higher than the spec. while robot moving. 2. Check the temperature on View-&gt;Status</p> <p>[Additional Explanation] The temperature would rise during robot operating and the work space temperature will affect as well.</p> <p>[Solution]</p> <ol style="list-style-type: none"> <li>1. Make sure the temperature of the working environment is within the specification.</li> <li>2. Make sure the payload or the project speed is within the specification</li> <li>3. Shut down the robot, and keep it cool for a while before start up again.</li> <li>4. If this issue still occurs, please contact a qualified service engineer for further analysis</li> </ol>
ErrorSuggestion0045F073	<p>[Cause] G sensor overload</p> <p>[Caution]</p> <ol style="list-style-type: none"> <li>1. Check if there robot has collided to the surroundings seriously</li> <li>2. Check the description of this error code to see which joint it belongs to</li> </ol> <p>[Solution]</p> <ol style="list-style-type: none"> <li>1. Adjust the payload, safety settings, speed and see if the issue still happens</li> <li>2. Make sure the payload (including the tool) is within the spec.</li> <li>3. Adjust the speed or movement to prevent the risk of having a single joint accelerate too fast</li> <li>4. If it still happens, export the Logs, Project and TCP used, and contact to your service engineer</li> <li>5. Make sure the robot will not collide with the surroundings during project run</li> </ol>
ErrorSuggestion0045F074	<p>[Cause] Hardware Failure</p> <p>[Caution]</p> <p>[Additional Explanation] This error is not likely happens, mostly because of hardware issue</p> <p>[Solution]</p> <ol style="list-style-type: none"> <li>1. Export the Logs</li> <li>2. Contact a qualified service engineer for further analysis</li> </ol>
ErrorSuggestion0045F075	<p>[Cause] Hardware Failure</p> <p>[Caution]</p> <p>[Restriction] Do not drive the joint with or without drive power when this issue happens</p> <p>[Solution]</p> <ol style="list-style-type: none"> <li>1. Export the Logs</li> <li>2. Contact a qualified service engineer for further analysis</li> <li>3. Make sure that the robot does not collide with the surroundings during operation</li> </ol>
ErrorSuggestion0045F0A4	Please contact the original purchase of the manufacturer or a third party designated maintenance unit.
ErrorSuggestion0045F0A5	Please contact the original purchase of the manufacturer or a third party designated maintenance unit.
ErrorSuggestion0045F0A6	Please contact the original purchase of the manufacturer or a third party designated maintenance unit.
ErrorSuggestion0045F111	Please contact the original purchase of the manufacturer or a third party designated maintenance unit.
ErrorSuggestion0045F112	Please contact the original purchase of the manufacturer or a third party designated maintenance unit.

ErrorSuggestion0045F113	Please contact the original purchase of the manufacturer or a third party designated maintenance unit.
ErrorSuggestion0045F114	Please contact the original purchase of the manufacturer or a third party designated maintenance unit.
ErrorSuggestion0045F115	[Cause]Encoder is abnormal [Caution] [Additional Explanation] This error is not likely happens, mostly because of hardware issue [Solution] 1. Export the log, 2. Contact a qualified service engineer for further analysis
ErrorSuggestion0045F116	1. Please try to restart the robot. 2. If the restart is invalid, please contact the original purchase or third-party designated maintenance units.
ErrorSuggestion0045F117	1. Please try to restart the robot. 2. If the restart is invalid, please contact the original purchase or third-party designated maintenance units.
ErrorSuggestion0045F118	1. Please try to restart the robot. 2. If the restart is invalid, please contact the original purchase or third-party designated maintenance units.
ErrorSuggestion0045F119	[Cause] 1. Motor is damaged 2. Joint PCB is damaged [Caution] [Additional Explanation] When the resistance of UVW current of motor is abnormal, it will report this error [Solution] 1. Export the log file 2. Contact a qualified service engineer
ErrorSuggestion0045F11A	[Cause]Hardware Failure [Caution] [Additional Explanation] The cables connection of UVW of motor is not correct. Quality issue or the robot may be disassembled abnormally. [Solution] 1. Export the log file 2. Contact a qualified service engineer 3. Make sure the robot is not being disassembled illegally
ErrorSuggestion0045F11B	[Cause] Hardware Failure [Caution] [Restriction] Do not drive the joint with or without drive power when this issue happens [Solution] 1. Export the Logs 2. Contact a qualified service engineer for further analysis 3. Make sure that the robot does not collide with the surroundings during operation
ErrorSuggestion0045F121	Please contact the original purchase of the manufacturer or a third party designated maintenance unit.
ErrorSuggestion0045F122	Please contact the original purchase of the manufacturer or a third party designated maintenance unit.
ErrorSuggestion0045F123	Please contact the original purchase of the manufacturer or a third party designated maintenance unit.
ErrorSuggestion0045F124	Please contact the original purchase of the manufacturer or a third party designated maintenance unit.
ErrorSuggestion0045F125	Please contact the original purchase of the manufacturer or a third party designated maintenance unit.
ErrorSuggestion0045F126	Please contact the original purchase of the manufacturer or a third party designated maintenance unit.
ErrorSuggestion0045F127	Please contact the original purchase of the manufacturer or a third party designated maintenance unit.
ErrorSuggestion0045F128	Please contact the original purchase of the manufacturer or a third party designated maintenance unit.
ErrorSuggestion0045F129	[Cause]Encoder is abnormal [Caution]

	[Additional Explanation] This error is not likely happens, mostly because of hardware issue
	[Solution]
	1. Export the log,
	2. Contact a qualified service engineer for further analysis
ErrorSuggestion0045F12A	Please contact the original purchase of the manufacturer or a third party designated maintenance unit.
ErrorSuggestion0045F12B	Please contact the original purchase of the manufacturer or a third party designated maintenance unit.
ErrorSuggestion0045F131	1. Please check grounding line is normal or not.
	2. Please contact the original purchase of the manufacturer or a third party designated maintenance unit.
ErrorSuggestion0045F132	Please contact the original purchase of the manufacturer or a third party designated maintenance unit.
ErrorSuggestion0045F133	[Cause]Robot detect a sudden voltage drop on DCBUS.
	[Caution]
	[Additional Explanation] There may be a variety of reasons that cause a low voltage, for example:
	1. The payload and speed may not in the spec.
	2. Power supply is abnormal
	[Precaution] Power off and unplug the power cable before opening the control box for items checking
	[Solution]
	1. Shut down the robot, make sure the power source is stable then power on.
	2. Make sure the power source is robust for robot running.
	3. Adjust the payload, safety settings, speed and see if the issue still happens
	4. Make sure the payload (including the tool) is within the spec.
	5. Adjust the speed or movement to prevent the risk of having a single joint accelerate too fast
	6. If it still happens, export the Logs, Project and TCP used, and contact to your service engineer
ErrorSuggestion0045F134	[Cause] The communication time of EtherCAT is timeout
	[Caution] Check if any external EtherCAT device used has lost connection
	[Additional Explanation] System will periodic check the EtherCAT communication, if communication timeout, it will report this error.
	[Solution]
	Contact a qualified service engineer for further analysis
ErrorSuggestion0045F135	[Cause]Joint movement range is over range during brake release process
	[Caution]Check if the payload is too that out of specification, including the mass, center of mass, inertia, etc.
	[Additional Explanation] System will detect the movement range while brake release process, when the value is over expected, it will report this error.
	[Solution]
	1. Power off the robot
	2. Remove all payload and restart the robot
	3. Make sure the payload is within specification (including the center of mass and inertia)
	4. Make sure there is no unexpected force acting on the robot during brake release process
	5. If this issue still happens, have a qualified service engineer for further analysis
ErrorSuggestion0045F136	[Cause] Current for solenoid is over specification during brake release process
	[Additional Explanation] System will detect the current for solenoid during brake releasing process, when it find the value over specification, it will report this error
	[Solution]
	1. Please press ESTOP button and release it to resume Robot to see the issue is still occurred or not.
	2. If this still occurs, contact a qualified service engineer for further analysis
ErrorSuggestion0045F137	[Cause]Robot detect a low voltage on DCBUS.
	[Caution]
	[Additional Explanation] There may be a variety of reasons that cause a low voltage, for example:

ErrorSuggestion0045F138	<ol style="list-style-type: none"> <li>1. The power source is not stable on customer-site</li> <li>2. Power supply is abnormal</li> <li>3. etc.</li> </ol> <p>[Precaution] Power off and unplug the power cable before opening the control box for items checking</p> <p>[Solution]</p> <ol style="list-style-type: none"> <li>1. Shut down the robot, make sure the power source is stable then power on.</li> <li>2. Make sure the power source is robust for robot running.</li> <li>3. If the same issue still occurs, contact a qualified service engineer for further analysis</li> </ol> <p>[Cause] Robot detect the voltage on DCBUS is higher than spec.</p> <p>[Caution] Check whether there are others error log along with this error.</p> <p>[Additional Explanation] There may be a variety of reasons that cause a high voltage, for example:</p> <ol style="list-style-type: none"> <li>1. The robot move too fast with the current project (with heavy payload)</li> <li>2. Power eater modules is abnormal</li> <li>3. etc.</li> </ol>
ErrorSuggestion0045F139	<p>[Precaution] Power off and unplug the power cable before opening the control box for items checking</p> <p>[Solution]</p> <ol style="list-style-type: none"> <li>1. Make sure the robot would not be collided and be placed on a unstable platform.</li> <li>2. Make sure project speed with payload is within the specification.</li> <li>3. After restart the robot, the problem still occur, contact a qualified service engineer for further analysis</li> </ol> <p>[Cause] Robot detect a sudden voltage drop on DCBUS.</p> <p>[Caution]</p> <p>[Additional Explanation] There may be a variety of reasons that cause a low voltage, for example:</p> <ol style="list-style-type: none"> <li>1. The payload and speed may not in the spec.</li> <li>2. Power supply is abnormal</li> </ol>
ErrorSuggestion0045F141	<p>[Precaution] Power off and unplug the power cable before opening the control box for items checking</p> <p>[Solution]</p> <ol style="list-style-type: none"> <li>1. Shut down the robot, make sure the power source is stable then power on.</li> <li>2. Make sure the power source is robust for robot running.</li> <li>3. Adjust the payload, safety settings, speed and see if the issue still happens</li> <li>4. Make sure the payload (including the tool) is within the spec.</li> <li>5. Adjust the speed or movement to prevent the risk of having a single joint accelerate too fast</li> <li>6. If it still happens, export the Logs, Project and TCP used, and contact to your service engineer</li> </ol>
ErrorSuggestion0045F142	<ol style="list-style-type: none"> <li>1. Please try to restart the robot.</li> <li>2. If the restart is invalid, please contact the original purchase or third-party designated maintenance units.</li> </ol>
ErrorSuggestion0045F143	<ol style="list-style-type: none"> <li>1. Please try to restart the robot.</li> <li>2. If the restart is invalid, please contact the original purchase or third-party designated maintenance units.</li> </ol>
ErrorSuggestion0045F144	<ol style="list-style-type: none"> <li>1. Please try to restart the robot.</li> <li>2. If the restart is invalid, please contact the original purchase or third-party designated maintenance units.</li> </ol>
ErrorSuggestion0045F145	<p>[Cause] Encoder is dysfunctional</p> <p>[Caution]</p> <p>[Additional Explanation] This error is not likely happens, mostly because of hardware issue</p> <p>[Solution]</p> <ol style="list-style-type: none"> <li>1. Export the Logs</li> <li>2. Contact a qualified service engineer for further analysis</li> </ol>

ErrorSuggestion0045F146	<p>[Cause] Encoder is dysfunctional</p> <p>[Caution]</p> <p>[Additional Explanation] This error is not likely happens, mostly because of hardware issue</p> <p>[Solution]</p> <ol style="list-style-type: none"> <li>1. Export the Logs</li> <li>2. Contact a qualified service engineer for further analysis</li> </ol>
ErrorSuggestion0045F147	<p>[Cause] Encoder is dysfunctional</p> <p>[Caution]</p> <p>[Additional Explanation] This error is not likely happens, mostly because of hardware issue</p> <p>[Solution]</p> <ol style="list-style-type: none"> <li>1. Export the Logs</li> <li>2. Contact a qualified service engineer for further analysis</li> </ol>
ErrorSuggestion0045F148	<p>[Cause] Encoder is dysfunctional</p> <p>[Caution]</p> <p>[Additional Explanation] This error is not likely happens, mostly because of hardware issue</p> <p>[Solution]</p> <ol style="list-style-type: none"> <li>1. Export the Logs</li> <li>2. Contact a qualified service engineer for further analysis</li> </ol>
ErrorSuggestion0045F149	<ol style="list-style-type: none"> <li>1. Please try to restart the robot.</li> <li>2. If the restart is invalid, please contact the original purchase or third-party designated maintenance units.</li> </ol>
ErrorSuggestion0045F1A1	<ol style="list-style-type: none"> <li>1. Please try to restart the robot.</li> <li>2. If the restart is invalid, please contact the original purchase or third-party designated maintenance units.</li> </ol>
ErrorSuggestion0045F1A2	<ol style="list-style-type: none"> <li>1. Please try to restart the robot.</li> <li>2. If the restart is invalid, please contact the original purchase or third-party designated maintenance units.</li> </ol>
ErrorSuggestion0045F1A3	<ol style="list-style-type: none"> <li>1. Please try to restart the robot.</li> <li>2. If the restart is invalid, please contact the original purchase or third-party designated maintenance units.</li> </ol>
ErrorSuggestion0045FF20	<p>[Cause] Current for solenoid is over specification during brake release process</p> <p>[Additional Explanation] System will detect the current for solenoid during brake releasing process, when it find the value over specification, it will report this error</p> <p>[Solution]</p> <ol style="list-style-type: none"> <li>1. Please press ESTOP button and release it to resume Robot to see the issue is still occurred or not.</li> <li>2. If this still occurs, contact a qualified service engineer for further analysis</li> </ol>
ErrorSuggestion0045FF21	<p>[Cause]Joint movement range is over range during brake release process</p> <p>[Caution]Check if the payload is too that out of specification, including the mass, center of mass, inertia, etc.</p> <p>[Additional Explanation] System will detect the movement range while brake release process, when the value is over expected, it will report this error.</p> <p>[Solution]</p> <ol style="list-style-type: none"> <li>1. Power off the robot</li> <li>2. Remove all payload and restart the robot</li> <li>3. Make sure the payload is within specification (including the center of mass and inertia)</li> <li>4. Make sure there is no unexpected force acting on the robot during brake release process</li> <li>5. If this issue still happens, have a qualified service engineer for further analysis</li> </ol>
ErrorSuggestion0045FFA0	<p>[Cause]Robot detect a low voltage on DCBUS.</p> <p>[Caution]Check if the payload is too that out of specification, including the mass, center of mass, inertia, etc.</p> <p>[Additional Explanation] There may be a variety of reasons that cause a low voltage, for example:</p> <ol style="list-style-type: none"> <li>1. The power source is not stable on customer-site</li> <li>2. Power supply is abnormal</li> </ol>

ErrorSuggestion0045FFA1	<p>3. etc.</p> <p>[Precaution] Power off and unplug the power cable before opening the control box for items checking</p> <p>[Solution]</p> <p>Shut down the robot, make sure the power source is stable then power on. If the same issue still occurs, contact a qualified service engineer for further analysis</p> <p>Make sure the power source is robust for robot running.</p> <p>[Cause]Robot detect the voltage on DCBUS is higher than spec.</p> <p>[Caution]Check whether there are others error log along with this error.</p> <p>[Additional Explanation] There may be a variety of reasons that cause a high voltage, for example:</p> <ol style="list-style-type: none"> <li>1. The robot move too fast with the current project (with heavy payload)</li> <li>2. Power eater modules is abnormal</li> <li>3. etc.</li> </ol> <p>[Precaution] Power off and unplug the power cable before opening the control box for items checking</p> <p>[Solution]</p>
ErrorSuggestion0045FFA2	<p>After restart the robot, the problem still occur, contact a qualified service engineer for further analysis</p> <ol style="list-style-type: none"> <li>1. Make sure the robot would not be collided and be placed on a unstable platform.</li> <li>2. Make sure project speed with payload is within the specification.</li> </ol>
ErrorSuggestion0045FFA3	<p>Be careful! G sensor overload on X direction.</p>
ErrorSuggestion0045FFA4	<p>Be careful! G sensor overload on Y direction.</p>
ErrorSuggestion0045FFA5	<p>Be careful! G sensor overload on Z direction.</p> <p>[Cause]Robot detect the temperature on PCB is higher than spec.</p> <p>[Caution]1. Check if the environment temperature is higher than the spec. while robot moving.</p> <ol style="list-style-type: none"> <li>2. Check the temperature on View-&gt;Status</li> </ol> <p>[Additional Explanation] The temperature would rise during robot operating and the work space temperature will affect as well.</p> <p>[Solution]</p> <p>Shut down the robot, and keep it cool for a while before start up again. If this issue still occurs, please contact a qualified service engineer for further analysis</p> <ol style="list-style-type: none"> <li>1. Make sure the temperature of the working environment is within the specification.</li> <li>2. Make sure the payload or the project speed is within the specification</li> </ol>
ErrorSuggestion0045FFA6	<p>[Cause]Robot has detected an overshoot of U phase current on the motor</p> <p>[Caution]</p> <ol style="list-style-type: none"> <li>1. Check the header of the error code to see which motor is with this issue</li> <li>2. Check if the robot is run with payload out of spec. and also in high speed</li> <li>3. Check if the safety settings of the robot</li> </ol> <p>[Additional Explanation] If the robot is driven and accelerate fast, current of the motor will overshoot and trigger this error</p> <p>[Additional Explanation] This is usually be triggered when running the robot with a heavy payload with high speed which is nearly or already out of spec.</p> <p>[Additional Explanation] Another reason may be there is dysfunction on the electronics on the motors</p> <p>[Solution]</p> <ol style="list-style-type: none"> <li>1. Shut down and reboot the robot</li> <li>2. Adjust the payload, safety settings, speed and see if the issue still happens</li> <li>3. Make sure the payload (including the tool) is within the spec.</li> <li>4. Adjust the speed or movement to prevent the risk of having a single joint accelerate too fast</li> <li>5. If it still happens, export the Logs, Project and TCP used, and contact to your service engineer</li> </ol>



ErrorSuggestion0045FFA7

[Cause]Robot has detected a overshoot of V phase current on the motor

[Caution]

1. Check the header of the error code to see which motor is with this issue
2. Check if the robot is run with payload out of spec. and also in high speed
3. Check if the safety settings of the robot

[Additional Explanation] If the robot is driven and accelerate fast, current of the motor will overshoot and trigger this error

[Additional Explanation] This is usually be triggered when running the robot with a heavy payload with high speed which is nearly or already out of spec.

[Additional Explanation] Another reason may be there is dysfunction on the electronics on the motors

[Solution]

1. Shut down and reboot the robot
2. Adjust the payload, safety settings, speed and see if the issue still happens
3. Make sure the payload (including the tool) is within the spec.
4. Adjust the speed or movement to prevent the risk of having a single joint accelerate too fast
5. If it still happens, export the Logs, Project and TCP used, and contact to your service engineer

ErrorSuggestion0045FFA8

[Cause]Robot has detected a overshoot of W phase current on the motor

[Caution]

1. Check the header of the error code to see which motor is with this issue
2. Check if the robot is run with payload out of spec. and also in high speed
3. Check if the safety settings of the robot

[Additional Explanation] If the robot is driven and accelerate fast, current of the motor will overshoot and trigger this error

[Additional Explanation] This is usually be triggered when running the robot with a heavy payload with high speed which is nearly or already out of spec.

[Additional Explanation] Another reason may be there is dysfunction on the electronics on the motors

[Solution]

1. Shut down and reboot the robot
2. Adjust the payload, safety settings, speed and see if the issue still happens
3. Make sure the payload (including the tool) is within the spec.
4. Adjust the speed or movement to prevent the risk of having a single joint accelerate too fast
5. If it still happens, export the Logs, Project and TCP used, and contact to your service engineer

ErrorSuggestion0045FFA9

Be careful! Motor current protection on U phase triggered, which may be caused by impact.

ErrorSuggestion0045FFAA

Be careful! Motor current protection on V phase triggered, which may be caused by impact.

ErrorSuggestion0045FFAB

[Cause]The motor current rises sudden and triggers motor hold protection

[Caution]

1. Check if there robot has collided to the surroundings seriously
2. Check the description of this error code to see which joint it belongs to

[Additional Explanation] When the robot collides to a solid object in a high speed, some of the joints may suffer a great torque on them and this causes the motor current raise rapidly and trigger this error

[Precaution] Do not drive the joint manually when this error occurs, which might damage the joint

[Solution]

1. Shut down and reboot the robot
2. Adjust the payload, safety settings, speed and see if the issue still happens
3. Make sure the payload (including the tool) is within the spec.
4. Adjust the speed or movement to prevent the risk of having a single joint accelerate too fast



ErrorSuggestion0045FFAC	5. If it still happens, export the Logs, Project and TCP used, and contact to your service engineer
ErrorSuggestion0045FFAD	6. Make sure the robot will not collide with the surroundings during project run
ErrorSuggestion0045FFAE	a error occurred in the UVW signal on optical encoder The index of encoder is not calibrated. [Cause] Robot has detected the current on DCBUS went too high suddenly. [Caution] 1. The speed(ABS/project speed) is too fast. 2. Check whether there is any collision while robot moving. [Additional Explanations] If robot is moving in a high speed in some movement or pose, it would cause this error. And if robot has collisions, it would cause the current became abnormal. [Solution][General User] 1. Slow down the speed(ABS/project speed). 2. Avoid any collision while robot is moving. 3. After restart the robot, the problem still occur, contact a qualified service engineer for further analysis.
ErrorSuggestion0045FFAF	[Cause] The communication time of EtherCAT is timeout [Caution] Check if any external EtherCAT device used has lost connection [Additional Explanation] System will periodic check the EtherCAT communication, if communication timeout, it will report this error. [Solution] Contact a qualified service engineer for further analysis
ErrorSuggestion0045FFB1	[Cause] The communication time of SPI is timeout [Caution] [Additional Explanation] It may possibly because the SPI IC is dysfunction which is not likely to happen [Solution] Contact a qualified service engineer for further analysis
ErrorSuggestion0045FFB2	1. Please check grounding line is normal or not. 2. Please contact the original purchase of the manufacturer or a third party designated maintenance unit.
ErrorSuggestion0045FFB3	Please contact the original purchase of the manufacturer or a third party designated maintenance unit.
ErrorSuggestion0045FFB4	1. Please try to restart the robot. 2. If the restart is invalid, please contact the original purchase or third-party designated maintenance units.
ErrorSuggestion0045FFB5	1. Please try to restart the robot. 2. If the restart is invalid, please contact the original purchase or third-party designated maintenance units.
ErrorSuggestion0045FFB6	Please contact the original purchase of the manufacturer or a third party designated maintenance unit.
ErrorSuggestion0045FFB7	Please check the functionality of break unit
ErrorSuggestion0045FFB8	[Cause] Hardware Failure [Caution] [Additional Explanation] This error is not likely happens, mostly because of hardware issue [Solution] 1. Export the Logs 2. Contact a qualified service engineer for further analysis
ErrorSuggestion0045FFB9	[Cause] Hardware Failure [Caution] [Additional Explanation] This error is not likely happens, mostly because of hardware issue [Solution] 1. Export the Logs 2. Contact a qualified service engineer for further analysis

ErrorSuggestion0045FFBA	<p>[Cause] Hardware Failure</p> <p>[Caution]</p> <p>[Restriction] Do not pull the joint forcibly when the problem occurs, so as not to cause damage to the joint</p> <p>[Solution]</p> <ol style="list-style-type: none"> <li>1. Export the Logs</li> <li>2. Contact a qualified service engineer for further analysis</li> <li>3. Make sure that the robot does not collide with the surroundings during operation</li> </ol>
ErrorSuggestion0045FFC0	a error occurred in transit to absolute position
ErrorSuggestion0045FFC1	Please contact the original purchase of the manufacturer or a third party designated maintenance unit.
ErrorSuggestion0045FFC2	Please contact the original purchase of the manufacturer or a third party designated maintenance unit.
ErrorSuggestion0045FFC3	Please contact the original purchase of the manufacturer or a third party designated maintenance unit.
ErrorSuggestion0045FFC4	Please contact the original purchase of the manufacturer or a third party designated maintenance unit.
ErrorSuggestion0045FFC5	Please contact the original purchase of the manufacturer or a third party designated maintenance unit.
ErrorSuggestion0045FFC6	Please contact the original purchase of the manufacturer or a third party designated maintenance unit.
ErrorSuggestion0045FFC7	Please contact the original purchase of the manufacturer or a third party designated maintenance unit.
ErrorSuggestion0045FFC8	Please contact the original purchase of the manufacturer or a third party designated maintenance unit.
ErrorSuggestion0045FFC9	Please contact the original purchase of the manufacturer or a third party designated maintenance unit.
ErrorSuggestion0045FFCA	<p>[Cause] Encoder is dysfunctional</p> <p>[Caution]</p> <p>[Additional Explanation] This error is not likely happens, mostly because of hardware issue</p> <p>[Solution]</p> <ol style="list-style-type: none"> <li>1. Export the Logs</li> <li>2. Contact a qualified service engineer for further analysis</li> </ol>
ErrorSuggestion0045FFCB	Please reduce the motion speed, check the flow and the speed and posture in each node
ErrorSuggestion0045FFCC	<p>[Cause] Encoder is dysfunctional</p> <p>[Caution]</p> <p>[Additional Explanation] This error is not likely happens, mostly because of hardware issue</p> <p>[Solution]</p> <ol style="list-style-type: none"> <li>1. Export the Logs</li> <li>2. Contact a qualified service engineer for further analysis</li> </ol>
ErrorSuggestion0045FFCD	<p>[Cause] Hardware Failure</p> <p>[Caution]</p> <p>[Restriction] Do not drive the joint with or without drive power when this issue happens</p> <p>[Solution]</p> <ol style="list-style-type: none"> <li>1. Export the Logs</li> <li>2. Contact a qualified service engineer for further analysis</li> <li>3. Make sure that the robot does not collide with the surroundings during operation</li> </ol>
ErrorSuggestion0045FFCE	<p>[Cause] Hardware Failure</p> <p>[Caution]</p> <p>[Restriction] Do not drive the joint with or without drive power</p> <p>[Solution]</p> <ol style="list-style-type: none"> <li>1. Export the Logs</li> <li>2. Contact a qualified service engineer for further analysis</li> </ol>
ErrorSuggestion0045FFCF	<p>[Cause] The motor current rises sudden and triggers motor hold protection</p> <p>[Caution]</p> <ol style="list-style-type: none"> <li>1. Check if there robot has collided to the surroundings seriously</li> <li>2. Check the description of this error code to see which joint it belongs to</li> </ol>

	<p>[Additional Explanation] When the robot collides to a solid object in a high speed, some of the joints may suffer a great torque on them and this causes the motor current raise rapidly and trigger this error</p> <p>[Precaution] Do not drive the joint manually when this error occurs, which might damage the joint</p> <p>[Solution]</p> <ol style="list-style-type: none"> <li>1. Shut down and reboot the robot</li> <li>2. Adjust the payload, safety settings, speed and see if the issue still happens</li> <li>3. Make sure the payload (including the tool) is within the spec.</li> <li>4. Adjust the speed or movement to prevent the risk of having a single joint accelerate too fast</li> <li>5. If it still happens, export the Logs, Project and TCP used, and contact to your service engineer</li> <li>6. Make sure the robot will not collide with the surroundings during project run</li> </ol>
ErrorSuggestion0045FFD0	Please check the UVW signal on encoder
ErrorSuggestion0045FFD1	<p>[Cause] Hardware Failure</p> <p>[Caution] Check if the robot is placed near any device with strong magnetic field</p> <p>[Additional Explanation] Under a strong magnetic field may affect the readings of the magnetic encoder</p> <p>[Solution]</p> <ol style="list-style-type: none"> <li>1. Export the Logs</li> <li>2. Make sure the robot is not under any strong magnetic field and then reboot the robot</li> <li>3. If this still does not work, Contact a qualified service engineer for further analysis</li> </ol>
ErrorSuggestion0045FFD2	<p>[Cause] Hardware Failure</p> <p>[Caution] Check if the robot is placed near any device with strong magnetic field</p> <p>[Additional Explanation] Under a strong magnetic field may affect the readings of the magnetic encoder</p> <p>[Solution]</p> <ol style="list-style-type: none"> <li>1. Export the Logs</li> <li>2. Make sure the robot is not under any strong magnetic field and then reboot the robot</li> <li>3. If this still does not work, Contact a qualified service engineer for further analysis</li> </ol>
ErrorSuggestion0045FFD3	<p>[Cause]</p> <ol style="list-style-type: none"> <li>1. The robot may be disassembled abnormally. Please check the warranty sticker and thread-locking fluid are both broken or not</li> <li>2. Joint gear wear out</li> </ol> <p>[Caution]</p> <p>[Additional Explanation] When the origin of joint module is not detected, it will report this error</p> <p>[Solution]</p> <ol style="list-style-type: none"> <li>1. Export the Logs</li> <li>2. Contact a qualified service engineer for further analysis</li> </ol>
ErrorSuggestion0045FFD4	Please contact the original purchase of the manufacturer or a third party designated maintenance unit.
ErrorSuggestion0045FFD5	Please contact the original purchase of the manufacturer or a third party designated maintenance unit.
ErrorSuggestion0045FFD6	Please contact the original purchase of the manufacturer or a third party designated maintenance unit.
ErrorSuggestion0045FFD7	Please contact the original purchase of the manufacturer or a third party designated maintenance unit.
ErrorSuggestion0045FFD8	<p>[Cause]</p> <ol style="list-style-type: none"> <li>1. Motor is damaged</li> <li>2. Joint PCB is damaged</li> </ol> <p>[Additional Explanation] When the resistance of UVW current of motor is abnormal, it will report this error</p> <p>[Solution]</p> <ol style="list-style-type: none"> <li>1. Export the log file</li> <li>2. Contact a qualified service engineer</li> </ol>

ErrorSuggestion0045FFD9	<p>[Cause] Hardware Failure</p> <p>[Additional Explanation] The cables connection of UVW of motor is not correct. Quality issue or the robot may be disassembled abnormally.</p> <p>[Solution]</p> <ol style="list-style-type: none"> <li>1. Export the log file</li> <li>2. Contact a qualified service engineer</li> <li>3. Make sure the robot is not being disassembled illegally</li> </ol>
ErrorSuggestion0045FFDA	Please contact the original purchase of the manufacturer or a third party designated maintenance unit.
ErrorSuggestion0045FFDB	Please contact the original purchase of the manufacturer or a third party designated maintenance unit.
ErrorSuggestion0045FFDC	Please contact the original purchase of the manufacturer or a third party designated maintenance unit.
ErrorSuggestion0045FFDD	<ol style="list-style-type: none"> <li>1. Please restart the robot.</li> <li>2. If the restart is invalid, please contact the original purchase or third-party designated maintenance units.</li> </ol>
ErrorSuggestion0045FFDE	<ol style="list-style-type: none"> <li>1. Please restart the robot.</li> <li>2. If the restart is invalid, please contact the original purchase or third-party designated maintenance units.</li> </ol>
ErrorSuggestion0045FFDF	<ol style="list-style-type: none"> <li>1. Please restart the robot.</li> <li>2. If the restart is invalid, please contact the original purchase or third-party designated maintenance units.</li> </ol>
ErrorSuggestion0045FFE0	<p>[Cause]</p> <ol style="list-style-type: none"> <li>1. Power supply is not stable.</li> <li>2. Robot moves in high speed, current is higher, voltage loss getting higher.(Vinput-Vloss=V for DC bus)</li> <li>3. Power connector problem, consume too much power</li> </ol> <p>[Additional Explanation] When robot is working and detects the voltage of DC bus is low, it will report this error</p> <p>[Solution]</p> <ol style="list-style-type: none"> <li>1. Power off the robot</li> <li>2. Check Robot Cable and its connector before power on again</li> <li>3. Reduce Robot speed if necessary</li> </ol> <p>Make sure power source is stable</p>
ErrorSuggestion0045FFE1	Please contact the original purchase of the manufacturer or a third party designated maintenance unit.
ErrorSuggestion0045FFE2	<ol style="list-style-type: none"> <li>1. Please restart the robot.</li> <li>2. If the restart is invalid, please contact the original purchase or third-party designated maintenance units.</li> </ol>
ErrorSuggestion0045FFE3	<ol style="list-style-type: none"> <li>1. Please restart the robot.</li> <li>2. If the restart is invalid, please contact the original purchase or third-party designated maintenance units.</li> </ol>
ErrorSuggestion0045FFE4	<p>[Cause] Encoder is abnormal</p> <p>[Additional Explanation] This error is not likely happens, mostly because of hardware issue</p> <p>[Solution]</p> <ol style="list-style-type: none"> <li>1. Export the log file</li> <li>2. Contact a qualified service engineer</li> </ol>
ErrorSuggestion0045FFE5	<ol style="list-style-type: none"> <li>1. Please restart the robot.</li> <li>2. If the restart is invalid, please contact the original purchase or third-party designated maintenance units.</li> </ol>
ErrorSuggestion0045FFE6	<ol style="list-style-type: none"> <li>1. Please restart the robot.</li> <li>2. If the restart is invalid, please contact the original purchase or third-party designated maintenance units.</li> </ol>
ErrorSuggestion0045FFE7	Please contact the original purchase of the manufacturer or a third party designated maintenance unit.
ErrorSuggestion0045FFE8	<p>[Cause]Hardware Failure</p> <p>[Additional Explanation] When the output of the G sensor is abnormal, it will report this error</p> <p>[Solution]</p> <ol style="list-style-type: none"> <li>1. Export the log file</li> <li>2. Contact a qualified service engineer</li> </ol>
ErrorSuggestion0045FFE9	Please contact the original purchase of the manufacturer or a third party designated maintenance unit.

ErrorSuggestion0045FFEA	<p>[Cause] DC to DC component on Join PCB is damaged</p> <p>[Additional Explanation] When detect voltage of 5V is abnormal, it will report this error</p> <p>[Solution]</p> <ol style="list-style-type: none"> <li>1. Export the log file</li> <li>2. Contact a qualified service engineer</li> </ol>
ErrorSuggestion0045FFEB	<p>[Cause] DC to DC component on Join PCB is damaged</p> <p>[Additional Explanation] When detect voltage of 12V is abnormal, it will report this error</p> <p>[Solution]</p> <ol style="list-style-type: none"> <li>1. Export the log file</li> <li>2. Contact a qualified service engineer</li> </ol>
ErrorSuggestion0045FFEC	Please contact the original purchase of the manufacturer or a third party designated maintenance unit.
ErrorSuggestion0045FFED	<p>[Cause] Encoder abnormal</p> <p>[Additional Explanation] This error is not likely happens, mostly because of hardware issue</p> <p>[Solution]</p> <p>[Solution]</p> <ol style="list-style-type: none"> <li>1. Export the log file</li> <li>2. Contact a qualified service engineer</li> </ol>
ErrorSuggestion0045FFEE	Please turn on joint modules
ErrorSuggestion0045FFEF	Please contact the original purchase of the manufacturer or a third party designated maintenance unit.
ErrorSuggestion00550000	No Error
ErrorSuggestion0055F051	<p>[Cause]Robot has detected an overshoot of U phase current on the motor</p> <p>[Caution]</p> <ol style="list-style-type: none"> <li>1. Check the header of the error code to see which motor is with this issue</li> <li>2. Check if the robot is run with payload out of spec and also in high speed</li> <li>3. Check if the safety settings of the robot</li> </ol> <p>[Additional Explanation] If the robot is driven and accelerate fast, current of the motor will overshoot and trigger this error</p> <p>[Additional Explanation] This is usually be triggered when running the robot with a heavy payload with high speed which is nearly or already out of spec.</p> <p>[Additional Explanation] Another reason may be there is dysfunction on the electronics on the motors</p> <p>[Solution]</p> <ol style="list-style-type: none"> <li>1. Shut down and reboot the robot</li> <li>2. Make sure the payload (including the tool) is within the spec.</li> <li>3. Adjust the speed or movement to prevent the risk of having a single joint accelerate too fast</li> <li>4. If it still happens, export the Logs, Project and TCP used, and contact to your service engineer</li> </ol>
ErrorSuggestion0055F052	<p>[Cause]Robot has detected a overshoot of V phase current on the motor</p> <p>[Caution]</p> <ol style="list-style-type: none"> <li>1. Check the header of the error code to see which motor is with this issue</li> <li>2. Check if the robot is run with payload out of spec. and also in high speed</li> <li>3. Check if the safety settings of the robot</li> </ol> <p>[Additional Explanation] If the robot is driven and accelerate fast, current of the motor will overshoot and trigger this error</p> <p>[Additional Explanation] This is usually be triggered when running the robot with a heavy payload with high speed which is nearly or already out of spec.</p> <p>[Additional Explanation] Another reason may be there is dysfunction on the electronics on the motors</p> <p>[Solution]</p> <ol style="list-style-type: none"> <li>1. Shut down and reboot the robot</li> </ol>

ErrorSuggestion0055F053

2. Make sure the payload (including the tool) is within the spec.
3. Adjust the speed or movement to prevent the risk of having a single joint accelerate too fast
4. If it still happens, export the Logs, Project and TCP used, and contact to your service engineer

[Cause]Robot has detected a overshoot of W phase current on the motor

[Caution]

1. Check the header of the error code to see which motor is with this issue
2. Check if the robot is run with payload out of spec. and also in high speed
3. Check if the safety settings of the robot

[Additional Explanation] If the robot is driven and accelerate fast, current of the motor will overshoot and trigger this error

[Additional Explanation] This is usually be triggered when running the robot with a heavy payload with high speed which is nearly or already out of spec.

[Additional Explanation] Another reason may be there is dysfunction on the electronics on the motors

[Solution]

1. Shut down and reboot the robot
2. Make sure the payload (including the tool) is within the spec.
3. Adjust the speed or movement to prevent the risk of having a single joint accelerate too fast
4. If it still happens, export the Logs, Project and TCP used, and contact to your service engineer

ErrorSuggestion0055F054

[Cause]Robot has detected the current on DCBUS went too high suddenly.

[Caution]

1. The speed (ABS/project speed) is too fast.
2. Check whether there is any collision while robot moving.

[Additional Explanations] If robot is moving in a high speed in some movement or pose, it would cause this error. And if robot has collisions, it would cause the current became abnormal.

[Solution][General User]

1. Slow down the speed (ABS/project speed).
2. Avoid any collision while robot is moving.
3. After restart the robot, the problem still occur, contact a qualified service engineer for further analysis.

ErrorSuggestion0055F055

[Cause]

1. Power supply is not stable.
2. Robot moves in high speed, current is higher, voltage loss getting higher.( $V_{input}-V_{loss}=V$  for DC bus)
3. Power connector problem, consume too much power

[Additional Explanation] When robot is working and detects the voltage of DC bus is low, it will report this error

[Solution]

1. Power off the robot
2. Check Robot Cable and its connector before power on again
3. Reduce Robot speed if necessary

Make sure power source is stable

ErrorSuggestion0055F056

[Cause]Robot detect the voltage on DCBUS is higher than spec.

[Caution]Check whether there are others error log along with this error.

[Additional Explanation] There may be a variety of reasons that cause a high voltage, for example:

1. The robot move too fast with the current project (with heavy payload)
2. Power eater modules is abnormal
3. etc.

[Precaution] Power off and unplug the power cable before opening the control box for items checking

[Solution]

1. Make sure the robot would not be collided and be placed on a unstable platform.

	<p>2. Make sure project speed with payload is within the specification.</p> <p>3. After restart the robot, the problem still occur, contact a qualified service engineer for further analysis</p>
ErrorSuggestion0055F057	<p>1. Please try to restart the robot.</p> <p>2. If the restart is invalid, please contact the original purchase or third-party designated maintenance units.</p>
ErrorSuggestion0055F058	<p>[Cause] DC to DC component on Join PCB is damaged</p> <p>[Additional Explanation] When detect voltage of 1.65V is abnormal, it will report this error</p> <p>[Solution]</p> <ol style="list-style-type: none"> <li>1. Export the log file</li> <li>2. Contact a qualified service engineer</li> </ol>
ErrorSuggestion0055F059	<p>[Cause] DC to DC component on Join PCB is damaged</p> <p>[Additional Explanation] When detect voltage of 12V is abnormal, it will report this error</p> <p>[Solution]</p> <ol style="list-style-type: none"> <li>1. Export the log file</li> <li>2. Contact a qualified service engineer</li> </ol>
ErrorSuggestion0055F05A	<p>[Cause] DC to DC component on Join PCB is damaged</p> <p>[Additional Explanation] When detect voltage of 6V is abnormal, it will report this error</p> <p>[Solution]</p> <ol style="list-style-type: none"> <li>1. Export the log file</li> <li>2. Contact a qualified service engineer</li> </ol>
ErrorSuggestion0055F05B	<p>[Cause] DC to DC component on Join PCB is damaged</p> <p>[Additional Explanation] When detect voltage of 3.3V is abnormal, it will report this error</p> <p>[Solution]</p> <ol style="list-style-type: none"> <li>1. Export the log file</li> <li>2. Contact a qualified service engineer</li> </ol>
ErrorSuggestion0055F05C	<p>[Cause] DC to DC component on Join PCB is damaged</p> <p>[Additional Explanation] When detect voltage of 1.2V is abnormal, it will report this error</p> <p>[Solution]</p> <ol style="list-style-type: none"> <li>1. Export the log file</li> <li>2. Contact a qualified service engineer</li> </ol>
ErrorSuggestion0055F061	<p>[Cause] The speed command is too large</p> <p>[Solution]</p> <ol style="list-style-type: none"> <li>1. Shut down and reboot the robot</li> <li>2. Reduce the motion speed, check the flow and the speed and posture in each node</li> <li>3. If it still happens, export the Logs, Project and TCP used, and contact to your service engineer</li> </ol>
ErrorSuggestion0055F062	<p>[Cause] The deviation between target and current position is too large</p> <p>[Solution]</p> <ol style="list-style-type: none"> <li>1. Shut down and reboot the robot</li> <li>2. Reduce the motion speed, check the flow, speed and posture in each node</li> <li>3. If it still happens, export the Logs, Project and TCP used, and contact to your service engineer</li> </ol>
ErrorSuggestion0055F063	<p>[Cause] The motor output command rises sudden and triggers motor hold protection</p> <p>[Caution]</p> <ol style="list-style-type: none"> <li>1. Check if there robot has collided to the surroundings seriously</li> <li>2. Check the description of this error code to see which joint it belongs to</li> </ol> <p>[Additional Explanation] When the robot collides to a solid object in a high speed, some of the joints may suffer a great torque on them and this causes the motor current raise rapidly and trigger this error</p> <p>[Precaution] Do not drive the joint manually when this error occurs, which might damage the joint</p>



ErrorSuggestion0055F064	<p>[Solution]</p> <ol style="list-style-type: none"> <li>1. Shut down and reboot the robot</li> <li>2. Adjust the payload, safety settings, speed and see if the issue still happens</li> <li>3. Make sure the payload (including the tool) is within the spec.</li> <li>4. Adjust the speed or movement to prevent the risk of having a single joint accelerate too fast</li> <li>5. If it still happens, export the Logs, Project and TCP used, and contact to your service engineer</li> <li>6. Make sure the robot will not collide with the surroundings during project run</li> </ol> <p>[Cause] The motor current rises sudden and triggers motor hold protection</p> <p>[Caution]</p> <ol style="list-style-type: none"> <li>1. Check if there robot has collided to the surroundings seriously</li> <li>2. Check the description of this error code to see which joint it belongs to</li> </ol> <p>[Additional Explanation] When the robot collides to a solid object in a high speed, some of the joints may suffer a great torque on them and this causes the motor current raise rapidly and trigger this error</p>
ErrorSuggestion0055F071	<p>[Precaution] Do not drive the joint manually when this error occurs, which might damage the joint</p> <p>[Solution]</p> <ol style="list-style-type: none"> <li>1. Shut down and reboot the robot</li> <li>2. Adjust the payload, safety settings, speed and see if the issue still happens</li> <li>3. Make sure the payload (including the tool) is within the spec.</li> <li>4. Adjust the speed or movement to prevent the risk of having a single joint accelerate too fast</li> <li>5. If it still happens, export the Logs, Project and TCP used, and contact to your service engineer</li> <li>6. Make sure the robot will not collide with the surroundings during project run</li> </ol> <p>[Cause] Hardware Failure</p> <p>[Caution]</p> <p>[Additional Explanation] This error is not likely happens, mostly because of hardware issue</p>
ErrorSuggestion0055F072	<p>[Solution]</p> <ol style="list-style-type: none"> <li>1. Export the Logs</li> <li>2. Contact a qualified service engineer for further analysis</li> </ol> <p>[Cause] Robot detect the temperature on PCB is higher than spec.</p> <p>[Caution]</p> <ol style="list-style-type: none"> <li>1. Check if the environment temperature is higher than the spec. while robot moving.</li> <li>2. Check the temperature on View-&gt;Status</li> </ol> <p>[Additional Explanation] The temperature would rise during robot operating and the work space temperature will affect as well.</p>
ErrorSuggestion0055F073	<p>[Solution]</p> <ol style="list-style-type: none"> <li>1. Make sure the temperature of the working environment is within the specification.</li> <li>2. Make sure the payload or the project speed is within the specification</li> <li>3. Shut down the robot, and keep it cool for a while before start up again.</li> <li>4. If this issue still occurs, please contact a qualified service engineer for further analysis</li> </ol> <p>[Cause] G sensor overload</p> <p>[Caution]</p> <ol style="list-style-type: none"> <li>1. Check if there robot has collided to the surroundings seriously</li> <li>2. Check the description of this error code to see which joint it belongs to</li> </ol> <p>[Solution]</p> <ol style="list-style-type: none"> <li>1. Adjust the payload, safety settings, speed and see if the issue still happens</li> <li>2. Make sure the payload (including the tool) is within the spec.</li> <li>3. Adjust the speed or movement to prevent the risk of having a single joint accelerate too fast</li> </ol>



	<p>4. If it still happens, export the Logs, Project and TCP used, and contact to your service engineer</p> <p>5. Make sure the robot will not collide with the surroundings during project run</p>
ErrorSuggestion0055F074	<p>[Cause] Hardware Failure</p> <p>[Caution]</p> <p>[Additional Explanation] This error is not likely happens, mostly because of hardware issue</p> <p>[Solution]</p> <ol style="list-style-type: none"> <li>1. Export the Logs</li> <li>2. Contact a qualified service engineer for further analysis</li> </ol>
ErrorSuggestion0055F075	<p>[Cause] Hardware Failure</p> <p>[Caution]</p> <p>[Restriction] Do not drive the joint with or without drive power when this issue happens</p> <p>[Solution]</p> <ol style="list-style-type: none"> <li>1. Export the Logs</li> <li>2. Contact a qualified service engineer for further analysis</li> <li>3. Make sure that the robot does not collide with the surroundings during operation</li> </ol>
ErrorSuggestion0055F0A4	Please contact the original purchase of the manufacturer or a third party designated maintenance unit.
ErrorSuggestion0055F0A5	Please contact the original purchase of the manufacturer or a third party designated maintenance unit.
ErrorSuggestion0055F0A6	Please contact the original purchase of the manufacturer or a third party designated maintenance unit.
ErrorSuggestion0055F111	Please contact the original purchase of the manufacturer or a third party designated maintenance unit.
ErrorSuggestion0055F112	Please contact the original purchase of the manufacturer or a third party designated maintenance unit.
ErrorSuggestion0055F113	Please contact the original purchase of the manufacturer or a third party designated maintenance unit.
ErrorSuggestion0055F114	Please contact the original purchase of the manufacturer or a third party designated maintenance unit.
ErrorSuggestion0055F115	<p>[Cause]Encoder is abnormal</p> <p>[Caution]</p> <p>[Additional Explanation] This error is not likely happens, mostly because of hardware issue</p> <p>[Solution]</p> <ol style="list-style-type: none"> <li>1. Export the log,</li> <li>2. Contact a qualified service engineer for further analysis</li> </ol>
ErrorSuggestion0055F116	<ol style="list-style-type: none"> <li>1. Please try to restart the robot.</li> <li>2. If the restart is invalid, please contact the original purchase or third-party designated maintenance units.</li> </ol>
ErrorSuggestion0055F117	<ol style="list-style-type: none"> <li>1. Please try to restart the robot.</li> <li>2. If the restart is invalid, please contact the original purchase or third-party designated maintenance units.</li> </ol>
ErrorSuggestion0055F118	<ol style="list-style-type: none"> <li>1. Please try to restart the robot.</li> <li>2. If the restart is invalid, please contact the original purchase or third-party designated maintenance units.</li> </ol>
ErrorSuggestion0055F119	<p>[Cause]</p> <ol style="list-style-type: none"> <li>1. Motor is damaged</li> <li>2. Joint PCB is damaged</li> </ol> <p>[Caution]</p> <p>[Additional Explanation] When the resistance of UVW current of motor is abnormal, it will report this error</p> <p>[Solution]</p> <ol style="list-style-type: none"> <li>1. Export the log file</li> <li>2. Contact a qualified service engineer</li> </ol>
ErrorSuggestion0055F11A	<p>[Cause]Hardware Failure</p> <p>[Caution]</p> <p>[Additional Explanation] The cables connection of UVW of motor is not correct. Quality issue or the robot may be disassembled abnormally.</p> <p>[Solution]</p>

	<ol style="list-style-type: none"> <li>1. Export the log file</li> <li>2. Contact a qualified service engineer</li> <li>3. Make sure the robot is not being disassembled illegally</li> </ol>
ErrorSuggestion0055F11B	<p>[Cause] Hardware Failure</p> <p>[Caution]</p> <p>[Restriction] Do not drive the joint with or without drive power when this issue happens</p> <p>[Solution]</p> <ol style="list-style-type: none"> <li>1. Export the Logs</li> <li>2. Contact a qualified service engineer for further analysis</li> <li>3. Make sure that the robot does not collide with the surroundings during operation</li> </ol>
ErrorSuggestion0055F121	Please contact the original purchase of the manufacturer or a third party designated maintenance unit.
ErrorSuggestion0055F122	Please contact the original purchase of the manufacturer or a third party designated maintenance unit.
ErrorSuggestion0055F123	Please contact the original purchase of the manufacturer or a third party designated maintenance unit.
ErrorSuggestion0055F124	Please contact the original purchase of the manufacturer or a third party designated maintenance unit.
ErrorSuggestion0055F125	Please contact the original purchase of the manufacturer or a third party designated maintenance unit.
ErrorSuggestion0055F126	Please contact the original purchase of the manufacturer or a third party designated maintenance unit.
ErrorSuggestion0055F127	Please contact the original purchase of the manufacturer or a third party designated maintenance unit.
ErrorSuggestion0055F128	Please contact the original purchase of the manufacturer or a third party designated maintenance unit.
ErrorSuggestion0055F129	<p>[Cause]Encoder is abnormal</p> <p>[Caution]</p> <p>[Additional Explanation] This error is not likely happens, mostly because of hardware issue</p> <p>[Solution]</p> <ol style="list-style-type: none"> <li>1. Export the log,</li> <li>2. Contact a qualified service engineer for further analysis</li> </ol>
ErrorSuggestion0055F12A	Please contact the original purchase of the manufacturer or a third party designated maintenance unit.
ErrorSuggestion0055F12B	Please contact the original purchase of the manufacturer or a third party designated maintenance unit.
ErrorSuggestion0055F131	<ol style="list-style-type: none"> <li>1. Please check grounding line is normal or not.</li> <li>2. Please contact the original purchase of the manufacturer or a third party designated maintenance unit.</li> </ol>
ErrorSuggestion0055F132	Please contact the original purchase of the manufacturer or a third party designated maintenance unit.
ErrorSuggestion0055F133	<p>[Cause]Robot detect a sudden voltage drop on DCBUS.</p> <p>[Caution]</p> <p>[Additional Explanation] There may be a variety of reasons that cause a low voltage, for example:</p> <ol style="list-style-type: none"> <li>1. The payload and speed may not in the spec.</li> <li>2. Power supply is abnormal</li> </ol> <p>[Precaution] Power off and unplug the power cable before opening the control box for items checking</p> <p>[Solution]</p> <ol style="list-style-type: none"> <li>1. Shut down the robot, make sure the power source is stable then power on.</li> <li>2. Make sure the power source is robust for robot running.</li> <li>3. Adjust the payload, safety settings, speed and see if the issue still happens</li> <li>4. Make sure the payload (including the tool) is within the spec.</li> <li>5. Adjust the speed or movement to prevent the risk of having a single joint accelerate too fast</li> <li>6. If it still happens, export the Logs, Project and TCP used, and contact to your service engineer</li> </ol>
ErrorSuggestion0055F134	<p>[Cause] The communication time of EtherCAT is timeout</p> <p>[Caution] Check if any external EtherCAT device used has lost connection</p> <p>[Additional Explanation] System will periodic check the EtherCAT communication, if communication timeout, it will report this error.</p>

ErrorSuggestion0055F135	<p>[Solution] Contact a qualified service engineer for further analysis</p> <p>[Cause]Joint movement range is over range during brake release process</p> <p>[Caution]Check if the payload is too that out of specification, including the mass, center of mass, inertia, etc.</p> <p>[Additional Explanation] System will detect the movement range while brake release process, when the value is over expected, it will report this error.</p>
ErrorSuggestion0055F136	<p>[Solution]</p> <ol style="list-style-type: none"> <li>1. Power off the robot</li> <li>2. Remove all payload and restart the robot</li> <li>3. Make sure the payload is within specification (including the center of mass and inertia)</li> <li>4. Make sure there is no unexpected force acting on the robot during brake release process</li> <li>5. If this issue still happens, have a qualified service engineer for further analysis</li> </ol> <p>[Cause] Current for solenoid is over specification during brake release process</p> <p>[Additional Explanation] System will detect the current for solenoid during brake releasing process, when it find the value over specification, it will report this error</p>
ErrorSuggestion0055F137	<p>[Solution]</p> <ol style="list-style-type: none"> <li>1. Please press ESTOP button and release it to resume Robot to see the issue is still occurred or not.</li> <li>2. If this still occurs, contact a qualified service engineer for further analysis</li> </ol> <p>[Cause]Robot detect a low voltage on DCBUS.</p> <p>[Caution]</p> <p>[Additional Explanation] There may be a variety of reasons that cause a low voltage, for example:</p> <ol style="list-style-type: none"> <li>1. The power source is not stable on customer-site</li> <li>2. Power supply is abnormal</li> <li>3. etc.</li> </ol> <p>[Precaution] Power off and unplug the power cable before opening the control box for items checking</p>
ErrorSuggestion0055F138	<p>[Solution]</p> <ol style="list-style-type: none"> <li>1. Shut down the robot, make sure the power source is stable then power on.</li> <li>2. Make sure the power source is robust for robot running.</li> <li>3. If the same issue still occurs, contact a qualified service engineer for further analysis</li> </ol> <p>[Cause]Robot detect the voltage on DCBUS is higher than spec.</p> <p>[Caution]Check whether there are others error log along with this error.</p> <p>[Additional Explanation] There may be a variety of reasons that cause a high voltage, for example:</p> <ol style="list-style-type: none"> <li>1. The robot move too fast with the current project (with heavy payload)</li> <li>2. Power eater modules is abnormal</li> <li>3. etc.</li> </ol> <p>[Precaution] Power off and unplug the power cable before opening the control box for items checking</p>
ErrorSuggestion0055F139	<p>[Solution]</p> <ol style="list-style-type: none"> <li>1. Make sure the robot would not be collided and be placed on a unstable platform.</li> <li>2. Make sure project speed with payload is within the specification.</li> <li>3. After restart the robot, the problem still occur, contact a qualified service engineer for further analysis</li> </ol> <p>[Cause]Robot detect a sudden voltage drop on DCBUS.</p> <p>[Caution]</p> <p>[Additional Explanation] There may be a variety of reasons that cause a low voltage, for example:</p> <ol style="list-style-type: none"> <li>1. The payload and speed may not in the spec.</li> <li>2. Power supply is abnormal</li> </ol> <p>[Precaution] Power off and unplug the power cable before opening the control box for items checking</p> <p>[Solution]</p>

	<ol style="list-style-type: none"> <li>1. Shut down the robot, make sure the power source is stable then power on.</li> <li>2. Make sure the power source is robust for robot running.</li> <li>3. Adjust the payload, safety settings, speed and see if the issue still happens</li> <li>4. Make sure the payload (including the tool) is within the spec.</li> <li>5. Adjust the speed or movement to prevent the risk of having a single joint accelerate too fast</li> <li>6. If it still happens, export the Logs, Project and TCP used, and contact to your service engineer</li> </ol>
ErrorSuggestion0055F141	<ol style="list-style-type: none"> <li>1. Please try to restart the robot.</li> <li>2. If the restart is invalid, please contact the original purchase or third-party designated maintenance units.</li> </ol>
ErrorSuggestion0055F142	<ol style="list-style-type: none"> <li>1. Please try to restart the robot.</li> <li>2. If the restart is invalid, please contact the original purchase or third-party designated maintenance units.</li> </ol>
ErrorSuggestion0055F143	<ol style="list-style-type: none"> <li>1. Please try to restart the robot.</li> <li>2. If the restart is invalid, please contact the original purchase or third-party designated maintenance units.</li> </ol>
ErrorSuggestion0055F144	<ol style="list-style-type: none"> <li>1. Please try to restart the robot.</li> <li>2. If the restart is invalid, please contact the original purchase or third-party designated maintenance units.</li> </ol>
ErrorSuggestion0055F145	<p>[Cause] Encoder is dysfunctional</p> <p>[Caution]</p> <p>[Additional Explanation] This error is not likely happens, mostly because of hardware issue</p> <p>[Solution]</p> <ol style="list-style-type: none"> <li>1. Export the Logs</li> <li>2. Contact a qualified service engineer for further analysis</li> </ol>
ErrorSuggestion0055F146	<p>[Cause] Encoder is dysfunctional</p> <p>[Caution]</p> <p>[Additional Explanation] This error is not likely happens, mostly because of hardware issue</p> <p>[Solution]</p> <ol style="list-style-type: none"> <li>1. Export the Logs</li> <li>2. Contact a qualified service engineer for further analysis</li> </ol>
ErrorSuggestion0055F147	<p>[Cause] Encoder is dysfunctional</p> <p>[Caution]</p> <p>[Additional Explanation] This error is not likely happens, mostly because of hardware issue</p> <p>[Solution]</p> <ol style="list-style-type: none"> <li>1. Export the Logs</li> <li>2. Contact a qualified service engineer for further analysis</li> </ol>
ErrorSuggestion0055F148	<p>[Cause] Encoder is dysfunctional</p> <p>[Caution]</p> <p>[Additional Explanation] This error is not likely happens, mostly because of hardware issue</p> <p>[Solution]</p> <ol style="list-style-type: none"> <li>1. Export the Logs</li> <li>2. Contact a qualified service engineer for further analysis</li> </ol>
ErrorSuggestion0055F149	<ol style="list-style-type: none"> <li>1. Please try to restart the robot.</li> <li>2. If the restart is invalid, please contact the original purchase or third-party designated maintenance units.</li> </ol>
ErrorSuggestion0055F1A1	<ol style="list-style-type: none"> <li>1. Please try to restart the robot.</li> <li>2. If the restart is invalid, please contact the original purchase or third-party designated maintenance units.</li> </ol>
ErrorSuggestion0055F1A2	<ol style="list-style-type: none"> <li>1. Please try to restart the robot.</li> <li>2. If the restart is invalid, please contact the original purchase or third-party designated maintenance units.</li> </ol>
ErrorSuggestion0055F1A3	<ol style="list-style-type: none"> <li>1. Please try to restart the robot.</li> <li>2. If the restart is invalid, please contact the original purchase or third-party designated maintenance units.</li> </ol>

ErrorSuggestion0055FF20	<p>[Cause] Current for solenoid is over specification during brake release process</p> <p>[Additional Explanation] System will detect the current for solenoid during brake releasing process, when it find the value over specification, it will report this error</p> <p>[Solution]</p> <ol style="list-style-type: none"> <li>1. Please press ESTOP button and release it to resume Robot to see the issue is still occurred or not.</li> <li>2. If this still occurs, contact a qualified service engineer for further analysis</li> </ol>
ErrorSuggestion0055FF21	<p>[Cause]Joint movement range is over range during brake release process</p> <p>[Caution]Check if the payload is too that out of specification, including the mass, center of mass, inertia, etc.</p> <p>[Additional Explanation] System will detect the movement range while brake release process, when the value is over expected, it will report this error.</p> <p>[Solution]</p> <ol style="list-style-type: none"> <li>1. Power off the robot</li> <li>2. Remove all payload and restart the robot</li> <li>3. Make sure the payload is within specification (including the center of mass and inertia)</li> <li>4. Make sure there is no unexpected force acting on the robot during brake release process</li> <li>5. If this issue still happens, have a qualified service engineer for further analysis</li> </ol>
ErrorSuggestion0055FFA0	<p>[Cause]Robot detect a low voltage on DCBUS.</p> <p>[Caution]Check if the payload is too that out of specification, including the mass, center of mass, inertia, etc.</p> <p>[Additional Explanation] There may be a variety of reasons that cause a low voltage, for example:</p> <ol style="list-style-type: none"> <li>1. The power source is not stable on customer-site</li> <li>2. Power supply is abnormal</li> <li>3. etc.</li> </ol> <p>[Precaution] Power off and unplug the power cable before opening the control box for items checking</p> <p>[Solution]</p> <p>Shut down the robot, make sure the power source is stable then power on. If the same issue still occurs, contact a qualified service engineer for further analysis</p> <p>Make sure the power source is robust for robot running.</p>
ErrorSuggestion0055FFA1	<p>[Cause]Robot detect the voltage on DCBUS is higher than spec.</p> <p>[Caution]Check whether there are others error log along with this error.</p> <p>[Additional Explanation] There may be a variety of reasons that cause a high voltage, for example:</p> <ol style="list-style-type: none"> <li>1. The robot move too fast with the current project (with heavy payload)</li> <li>2. Power eater modules is abnormal</li> <li>3. etc.</li> </ol> <p>[Precaution] Power off and unplug the power cable before opening the control box for items checking</p> <p>[Solution]</p> <p>After restart the robot, the problem still occur, contact a qualified service engineer for further analysis</p> <ol style="list-style-type: none"> <li>1. Make sure the robot would not be collided and be placed on a unstable platform.</li> <li>2. Make sure project speed with payload is within the specification.</li> </ol>
ErrorSuggestion0055FFA2	Be careful! G sensor overload on X direction.
ErrorSuggestion0055FFA3	Be careful! G sensor overload on Y direction.
ErrorSuggestion0055FFA4	Be careful! G sensor overload on Z direction.
ErrorSuggestion0055FFA5	<p>[Cause]Robot detect the temperature on PCB is higher than spec.</p> <p>[Caution]1. Check if the environment temperature is higher than the spec. while robot moving.</p> <p>2. Check the temperature on View-&gt;Status</p> <p>[Additional Explanation] The temperature would rise during robot operating and the work space temperature will affect as well.</p> <p>[Solution]</p>

ErrorSuggestion0055FFA6

Shut down the robot, and keep it cool for a while before start up again. If this issue still occurs, please contact a qualified service engineer for further analysis

1. Make sure the temperature of the working environment is within the specification.
2. Make sure the payload or the project speed is within the specification

[Cause]Robot has detected an overshoot of U phase current on the motor

[Caution]

1. Check the header of the error code to see which motor is with this issue
2. Check if the robot is run with payload out of spec. and also in high speed
3. Check if the safety settings of the robot

[Additional Explanation] If the robot is driven and accelerate fast, current of the motor will overshoot and trigger this error

[Additional Explanation] This is usually be triggered when running the robot with a heavy payload with high speed which is nearly or already out of spec.

[Additional Explanation] Another reason may be there is dysfunction on the electronics on the motors

[Solution]

1. Shut down and reboot the robot
2. Adjust the payload, safety settings, speed and see if the issue still happens
3. Make sure the payload (including the tool) is within the spec.
4. Adjust the speed or movement to prevent the risk of having a single joint accelerate too fast
5. If it still happens, export the Logs, Project and TCP used, and contact to your service engineer

ErrorSuggestion0055FFA7

[Cause]Robot has detected a overshoot of V phase current on the motor

[Caution]

1. Check the header of the error code to see which motor is with this issue
2. Check if the robot is run with payload out of spec. and also in high speed
3. Check if the safety settings of the robot

[Additional Explanation] If the robot is driven and accelerate fast, current of the motor will overshoot and trigger this error

[Additional Explanation] This is usually be triggered when running the robot with a heavy payload with high speed which is nearly or already out of spec.

[Additional Explanation] Another reason may be there is dysfunction on the electronics on the motors

[Solution]

1. Shut down and reboot the robot
2. Adjust the payload, safety settings, speed and see if the issue still happens
3. Make sure the payload (including the tool) is within the spec.
4. Adjust the speed or movement to prevent the risk of having a single joint accelerate too fast
5. If it still happens, export the Logs, Project and TCP used, and contact to your service engineer

ErrorSuggestion0055FFA8

[Cause]Robot has detected a overshoot of W phase current on the motor

[Caution]

1. Check the header of the error code to see which motor is with this issue
2. Check if the robot is run with payload out of spec. and also in high speed
3. Check if the safety settings of the robot

[Additional Explanation] If the robot is driven and accelerate fast, current of the motor will overshoot and trigger this error

[Additional Explanation] This is usually be triggered when running the robot with a heavy payload with high speed which is nearly or already out of spec.

[Additional Explanation] Another reason may be there is dysfunction on the electronics on the motors

[Solution]

ErrorSuggestion0055FFA9	<ol style="list-style-type: none"> <li>1. Shut down and reboot the robot</li> <li>2. Adjust the payload, safety settings, speed and see if the issue still happens</li> <li>3. Make sure the payload (including the tool) is within the spec.</li> <li>4. Adjust the speed or movement to prevent the risk of having a single joint accelerate too fast</li> <li>5. If it still happens, export the Logs, Project and TCP used, and contact to your service engineer</li> </ol>
ErrorSuggestion0055FFAA	Be careful! Motor current protection on U phase triggered, which may be caused by impact.
ErrorSuggestion0055FFAB	Be careful! Motor current protection on V phase triggered, which may be caused by impact.
	[Cause]The motor current rises sudden and triggers motor hold protection
	[Caution]
	<ol style="list-style-type: none"> <li>1. Check if there robot has collided to the surroundings seriously</li> <li>2. Check the description of this error code to see which joint it belongs to</li> </ol>
	[Additional Explanation] When the robot collides to a solid object in a high speed, some of the joints may suffer a great torque on them and this causes the motor current raise rapidly and trigger this error
	[Precaution] Do not drive the joint manually when this error occurs, which might damage the joint
	[Solution]
	<ol style="list-style-type: none"> <li>1. Shut down and reboot the robot</li> <li>2. Adjust the payload, safety settings, speed and see if the issue still happens</li> <li>3. Make sure the payload (including the tool) is within the spec.</li> <li>4. Adjust the speed or movement to prevent the risk of having a single joint accelerate too fast</li> <li>5. If it still happens, export the Logs, Project and TCP used, and contact to your service engineer</li> <li>6. Make sure the robot will not collide with the surroundings during project run</li> </ol>
ErrorSuggestion0055FFAC	a error occurred in the UVW signal on optical encoder
ErrorSuggestion0055FFAD	The index of encoder is not calibrated.
ErrorSuggestion0055FFAE	[Cause]Robot has detected the current on DCBUS went too high suddenly.
	[Caution]
	<ol style="list-style-type: none"> <li>1. The speed(ABS/project speed) is too fast.</li> <li>2. Check whether there is any collision while robot moving.</li> </ol> <p>[Additional Explanations] If robot is moving in a high speed in some movement or pose, it would cause this error. And if robot has collisions, it would cause the current became abnormal.</p>
	[Solution][General User]
	<ol style="list-style-type: none"> <li>1. Slow down the speed(ABS/project speed).</li> <li>2. Avoid any collision while robot is moving.</li> <li>3. After restart the robot, the problem still occur, contact a qualified service engineer for further analysis.</li> </ol>
ErrorSuggestion0055FFAF	[Cause] The communication time of EtherCAT is timeout
	[Caution] Check if any external EtherCAT device used has lost connection
	[Additional Explanation] System will periodic check the EtherCAT communication, if communication timeout, it will report this error.
	[Solution]
	Contact a qualified service engineer for further analysis
ErrorSuggestion0055FFB1	[Cause] The communication time of SPI is timeout
	[Caution]
	[Additional Explanation] It may possibly because the SPI IC is dysfunction which is not likely to happen
	[Solution]
	Contact a qualified service engineer for further analysis
ErrorSuggestion0055FFB2	<ol style="list-style-type: none"> <li>1. Please check grounding line is normal or not.</li> <li>2. Please contact the original purchase of the manufacturer or a third party designated maintenance unit.</li> </ol>



ErrorSuggestion0055FFB3	Please contact the original purchase of the manufacturer or a third party designated maintenance unit.
ErrorSuggestion0055FFB4	1. Please try to restart the robot. 2. If the restart is invalid, please contact the original purchase or third-party designated maintenance units.
ErrorSuggestion0055FFB5	1. Please try to restart the robot. 2. If the restart is invalid, please contact the original purchase or third-party designated maintenance units.
ErrorSuggestion0055FFB6	Please contact the original purchase of the manufacturer or a third party designated maintenance unit.
ErrorSuggestion0055FFB7	Please check the functionality of break unit
ErrorSuggestion0055FFB8	[Cause] Hardware Failure [Caution] [Additional Explanation] This error is not likely happens, mostly because of hardware issue [Solution] 1. Export the Logs 2. Contact a qualified service engineer for further analysis
ErrorSuggestion0055FFB9	[Cause] Hardware Failure [Caution] [Additional Explanation] This error is not likely happens, mostly because of hardware issue [Solution] 1. Export the Logs 2. Contact a qualified service engineer for further analysis
ErrorSuggestion0055FFBA	[Cause] Hardware Failure [Caution] [Restriction] Do not pull the joint forcibly when the problem occurs, so as not to cause damage to the joint [Solution] 1. Export the Logs 2. Contact a qualified service engineer for further analysis 3. Make sure that the robot does not collide with the surroundings during operation
ErrorSuggestion0055FFC0	a error occurred in transit to absolute position
ErrorSuggestion0055FFC1	Please contact the original purchase of the manufacturer or a third party designated maintenance unit.
ErrorSuggestion0055FFC2	Please contact the original purchase of the manufacturer or a third party designated maintenance unit.
ErrorSuggestion0055FFC3	Please contact the original purchase of the manufacturer or a third party designated maintenance unit.
ErrorSuggestion0055FFC4	Please contact the original purchase of the manufacturer or a third party designated maintenance unit.
ErrorSuggestion0055FFC5	Please contact the original purchase of the manufacturer or a third party designated maintenance unit.
ErrorSuggestion0055FFC6	Please contact the original purchase of the manufacturer or a third party designated maintenance unit.
ErrorSuggestion0055FFC7	Please contact the original purchase of the manufacturer or a third party designated maintenance unit.
ErrorSuggestion0055FFC8	Please contact the original purchase of the manufacturer or a third party designated maintenance unit.
ErrorSuggestion0055FFC9	Please contact the original purchase of the manufacturer or a third party designated maintenance unit.
ErrorSuggestion0055FFCA	[Cause] Encoder is dysfunctional [Caution] [Additional Explanation] This error is not likely happens, mostly because of hardware issue [Solution] 1. Export the Logs 2. Contact a qualified service engineer for further analysis
ErrorSuggestion0055FFCB	Please reduce the motion speed, check the flow and the speed and posture in each node
ErrorSuggestion0055FFCC	[Cause] Encoder is dysfunctional [Caution] [Additional Explanation] This error is not likely happens, mostly because of hardware issue [Solution]



ErrorSuggestion0055FFCD	<ol style="list-style-type: none"> <li>1. Export the Logs</li> <li>2. Contact a qualified service engineer for further analysis</li> </ol> <p>[Cause] Hardware Failure</p> <p>[Caution]</p> <p>[Restriction] Do not drive the joint with or without drive power when this issue happens</p> <p>[Solution]</p>
ErrorSuggestion0055FFCE	<ol style="list-style-type: none"> <li>1. Export the Logs</li> <li>2. Contact a qualified service engineer for further analysis</li> <li>3. Make sure that the robot does not collide with the surroundings during operation</li> </ol> <p>[Cause] Hardware Failure</p> <p>[Caution]</p> <p>[Restriction] Do not drive the joint with or without drive power</p> <p>[Solution]</p>
ErrorSuggestion0055FFCF	<ol style="list-style-type: none"> <li>1. Export the Logs</li> <li>2. Contact a qualified service engineer for further analysis</li> </ol> <p>[Cause] The motor current rises sudden and triggers motor hold protection</p> <p>[Caution]</p> <ol style="list-style-type: none"> <li>1. Check if there robot has collided to the surroundings seriously</li> <li>2. Check the description of this error code to see which joint it belongs to</li> </ol> <p>[Additional Explanation] When the robot collides to a solid object in a high speed, some of the joints may suffer a great torque on them and this causes the motor current raise rapidly and trigger this error</p> <p>[Precaution] Do not drive the joint manually when this error occurs, which might damage the joint</p> <p>[Solution]</p> <ol style="list-style-type: none"> <li>1. Shut down and reboot the robot</li> <li>2. Adjust the payload, safety settings, speed and see if the issue still happens</li> <li>3. Make sure the payload (including the tool) is within the spec.</li> <li>4. Adjust the speed or movement to prevent the risk of having a single joint accelerate too fast</li> <li>5. If it still happens, export the Logs, Project and TCP used, and contact to your service engineer</li> <li>6. Make sure the robot will not collide with the surroundings during project run</li> </ol>
ErrorSuggestion0055FFD0	Please check the UVW signal on encoder
ErrorSuggestion0055FFD1	<p>[Cause] Hardware Failure</p> <p>[Caution] Check if the robot is placed near any device with strong magnetic field</p> <p>[Additional Explanation] Under a strong magnetic field may affect the readings of the magnetic encoder</p> <p>[Solution]</p> <ol style="list-style-type: none"> <li>1. Export the Logs</li> <li>2. Make sure the robot is not under any strong magnetic field and then reboot the robot</li> <li>3. If this still does not work, Contact a qualified service engineer for further analysis</li> </ol>
ErrorSuggestion0055FFD2	<p>[Cause] Hardware Failure</p> <p>[Caution] Check if the robot is placed near any device with strong magnetic field</p> <p>[Additional Explanation] Under a strong magnetic field may affect the readings of the magnetic encoder</p> <p>[Solution]</p> <ol style="list-style-type: none"> <li>1. Export the Logs</li> <li>2. Make sure the robot is not under any strong magnetic field and then reboot the robot</li> <li>3. If this still does not work, Contact a qualified service engineer for further analysis</li> </ol>
ErrorSuggestion0055FFD3	<p>[Cause]</p> <ol style="list-style-type: none"> <li>1. The robot may be disassembled abnormally. Please check the warranty sticker and thread-locking fluid are both</li> </ol>

	broken or not
	2. Joint gear wear out
	[Caution]
	[Additional Explanation] When the origin of joint module is not detected, it will report this error
	[Solution]
	1. Export the Logs
	2. Contact a qualified service engineer for further analysis
ErrorSuggestion0055FFD4	Please contact the original purchase of the manufacturer or a third party designated maintenance unit.
ErrorSuggestion0055FFD5	Please contact the original purchase of the manufacturer or a third party designated maintenance unit.
ErrorSuggestion0055FFD6	Please contact the original purchase of the manufacturer or a third party designated maintenance unit.
ErrorSuggestion0055FFD7	Please contact the original purchase of the manufacturer or a third party designated maintenance unit.
ErrorSuggestion0055FFD8	[Cause]
	1. Motor is damaged
	2. Joint PCB is damaged
	[Additional Explanation] When the resistance of UVW current of motor is abnormal, it will report this error
	[Solution]
	1. Export the log file
	2. Contact a qualified service engineer
ErrorSuggestion0055FFD9	[Cause] Hardware Failure
	[Additional Explanation] The cables connection of UVW of motor is not correct. Quality issue or the robot may be disassembled abnormally.
	[Solution]
	1. Export the log file
	2. Contact a qualified service engineer
	3. Make sure the robot is not being disassembled illegally
ErrorSuggestion0055FFDA	Please contact the original purchase of the manufacturer or a third party designated maintenance unit.
ErrorSuggestion0055FFDB	Please contact the original purchase of the manufacturer or a third party designated maintenance unit.
ErrorSuggestion0055FFDC	Please contact the original purchase of the manufacturer or a third party designated maintenance unit.
ErrorSuggestion0055FFDD	1. Please restart the robot.
	2. If the restart is invalid, please contact the original purchase or third-party designated maintenance units.
ErrorSuggestion0055FFDE	1. Please restart the robot.
	2. If the restart is invalid, please contact the original purchase or third-party designated maintenance units.
ErrorSuggestion0055FFDF	1. Please restart the robot.
	2. If the restart is invalid, please contact the original purchase or third-party designated maintenance units.
ErrorSuggestion0055FFE0	[Cause]
	1. Power supply is not stable.
	2. Robot moves in high speed, current is higher, voltage loss getting higher. ( $V_{input} - V_{loss} = V$ for DC bus)
	3. Power connector problem, consume too much power
	[Additional Explanation] When robot is working and detects the voltage of DC bus is low, it will report this error
	[Solution]
	1. Power off the robot
	2. Check Robot Cable and its connector before power on again
	3. Reduce Robot speed if necessary
	Make sure power source is stable
ErrorSuggestion0055FFE1	Please contact the original purchase of the manufacturer or a third party designated maintenance unit.
ErrorSuggestion0055FFE2	1. Please restart the robot.
	2. If the restart is invalid, please contact the original purchase or third-party designated maintenance units.

ErrorSuggestion0055FFE3	1. Please restart the robot. 2. If the restart is invalid, please contact the original purchase or third-party designated maintenance units.
ErrorSuggestion0055FFE4	[Cause] Encoder is abnormal [Additional Explanation] This error is not likely happens, mostly because of hardware issue [Solution] 1. Export the log file 2. Contact a qualified service engineer
ErrorSuggestion0055FFE5	1. Please restart the robot. 2. If the restart is invalid, please contact the original purchase or third-party designated maintenance units.
ErrorSuggestion0055FFE6	1. Please restart the robot. 2. If the restart is invalid, please contact the original purchase or third-party designated maintenance units.
ErrorSuggestion0055FFE7	Please contact the original purchase of the manufacturer or a third party designated maintenance unit.
ErrorSuggestion0055FFE8	[Cause]Hardware Failure [Additional Explanation] When the output of the G sensor is abnormal, it will report this error [Solution] 1. Export the log file 2. Contact a qualified service engineer
ErrorSuggestion0055FFE9	Please contact the original purchase of the manufacturer or a third party designated maintenance unit.
ErrorSuggestion0055FFEA	[Cause] DC to DC component on Join PCB is damaged [Additional Explanation] When detect voltage of 5V is abnormal, it will report this error [Solution] 1. Export the log file 2. Contact a qualified service engineer
ErrorSuggestion0055FFEB	[Cause] DC to DC component on Join PCB is damaged [Additional Explanation] When detect voltage of 12V is abnormal, it will report this error [Solution] 1. Export the log file 2. Contact a qualified service engineer
ErrorSuggestion0055FFEC	Please contact the original purchase of the manufacturer or a third party designated maintenance unit.
ErrorSuggestion0055FFED	[Cause] Encoder abnormal [Additional Explanation] This error is not likely happens, mostly because of hardware issue [Solution] [Solution] 1. Export the log file 2. Contact a qualified service engineer
ErrorSuggestion0055FFEE	Please turn on joint modules
ErrorSuggestion0055FFEF	Please contact the original purchase of the manufacturer or a third party designated maintenance unit.
ErrorSuggestion00650000	No Error
ErrorSuggestion0065F051	[Cause]Robot has detected an overshoot of U phase current on the motor [Caution] 1. Check the header of the error code to see which motor is with this issue 2. Check if the robot is run with payload out of spec and also in high speed 3. Check if the safety settings of the robot [Additional Explanation] If the robot is driven and accelerate fast, current of the motor will overshoot and trigger this error [Additional Explanation] This is usually be triggered when running the robot with a heavy payload with high speed which is nearly or already out of spec.

ErrorSuggestion0065F052

[Additional Explanation] Another reason may be there is dysfunction on the electronics on the motors

[Solution]

1. Shut down and reboot the robot
2. Make sure the payload (including the tool) is within the spec.
3. Adjust the speed or movement to prevent the risk of having a single joint accelerate too fast
4. If it still happens, export the Logs, Project and TCP used, and contact to your service engineer

[Cause]Robot has detected a overshoot of V phase current on the motor

[Caution]

1. Check the header of the error code to see which motor is with this issue
2. Check if the robot is run with payload out of spec. and also in high speed
3. Check if the safety settings of the robot

[Additional Explanation] If the robot is driven and accelerate fast, current of the motor will overshoot and trigger this error

[Additional Explanation] This is usually be triggered when running the robot with a heavy payload with high speed which is nearly or already out of spec.

[Additional Explanation] Another reason may be there is dysfunction on the electronics on the motors

[Solution]

1. Shut down and reboot the robot
2. Make sure the payload (including the tool) is within the spec.
3. Adjust the speed or movement to prevent the risk of having a single joint accelerate too fast
4. If it still happens, export the Logs, Project and TCP used, and contact to your service engineer

ErrorSuggestion0065F053

[Cause]Robot has detected a overshoot of W phase current on the motor

[Caution]

1. Check the header of the error code to see which motor is with this issue
2. Check if the robot is run with payload out of spec. and also in high speed
3. Check if the safety settings of the robot

[Additional Explanation] If the robot is driven and accelerate fast, current of the motor will overshoot and trigger this error

[Additional Explanation] This is usually be triggered when running the robot with a heavy payload with high speed which is nearly or already out of spec.

[Additional Explanation] Another reason may be there is dysfunction on the electronics on the motors

[Solution]

1. Shut down and reboot the robot
2. Make sure the payload (including the tool) is within the spec.
3. Adjust the speed or movement to prevent the risk of having a single joint accelerate too fast
4. If it still happens, export the Logs, Project and TCP used, and contact to your service engineer

ErrorSuggestion0065F054

[Cause]Robot has detected the current on DCBUS went too high suddenly.

[Caution]

1. The speed (ABS/project speed) is too fast.
2. Check whether there is any collision while robot moving.

[Additional Explanations] If robot is moving in a high speed in some movement or pose, it would cause this error. And if robot has collisions, it would cause the current became abnormal.

[Solution][General User]

1. Slow down the speed (ABS/project speed).
2. Avoid any collision while robot is moving.
3. After restart the robot, the problem still occur, contact a qualified service engineer for further analysis.

ErrorSuggestion0065F055	<p>[Cause]</p> <ol style="list-style-type: none"> <li>1. Power supply is not stable.</li> <li>2. Robot moves in high speed, current is higher, voltage loss getting higher.(Vinput-Vloss=V for DC bus)</li> <li>3. Power connector problem, consume too much power</li> </ol> <p>[Additional Explanation] When robot is working and detects the voltage of DC bus is low, it will report this error</p> <p>[Solution]</p> <ol style="list-style-type: none"> <li>1. Power off the robot</li> <li>2. Check Robot Cable and its connector before power on again</li> <li>3. Reduce Robot speed if necessary</li> </ol> <p>Make sure power source is stable</p>
ErrorSuggestion0065F056	<p>[Cause]Robot detect the voltage on DCBUS is higher than spec.</p> <p>[Caution]Check whether there are others error log along with this error.</p> <p>[Additional Explanation] There may be a variety of reasons that cause a high voltage, for example:</p> <ol style="list-style-type: none"> <li>1. The robot move too fast with the current project (with heavy payload)</li> <li>2. Power eater modules is abnormal</li> <li>3. etc.</li> </ol> <p>[Precaution] Power off and unplug the power cable before opening the control box for items checking</p> <p>[Solution]</p> <ol style="list-style-type: none"> <li>1. Make sure the robot would not be collided and be placed on a unstable platform.</li> <li>2. Make sure project speed with payload is within the specification.</li> <li>3. After restart the robot, the problem still occur, contact a qualified service engineer for further analysis</li> </ol>
ErrorSuggestion0065F057	<ol style="list-style-type: none"> <li>1. Please try to restart the robot.</li> <li>2. If the restart is invalid, please contact the original purchase or third-party designated maintenance units.</li> </ol>
ErrorSuggestion0065F058	<p>[Cause] DC to DC component on Join PCB is damaged</p> <p>[Additional Explanation] When detect voltage of 1.65V is abnormal, it will report this error</p> <p>[Solution]</p> <ol style="list-style-type: none"> <li>1. Export the log file</li> <li>2. Contact a qualified service engineer</li> </ol>
ErrorSuggestion0065F059	<p>[Cause] DC to DC component on Join PCB is damaged</p> <p>[Additional Explanation] When detect voltage of 12V is abnormal, it will report this error</p> <p>[Solution]</p> <ol style="list-style-type: none"> <li>1. Export the log file</li> <li>2. Contact a qualified service engineer</li> </ol>
ErrorSuggestion0065F05A	<p>[Cause] DC to DC component on Join PCB is damaged</p> <p>[Additional Explanation] When detect voltage of 6V is abnormal, it will report this error</p> <p>[Solution]</p> <ol style="list-style-type: none"> <li>1. Export the log file</li> <li>2. Contact a qualified service engineer</li> </ol>
ErrorSuggestion0065F05B	<p>[Cause] DC to DC component on Join PCB is damaged</p> <p>[Additional Explanation] When detect voltage of 3.3V is abnormal, it will report this error</p> <p>[Solution]</p> <ol style="list-style-type: none"> <li>1. Export the log file</li> <li>2. Contact a qualified service engineer</li> </ol>
ErrorSuggestion0065F05C	<p>[Cause] DC to DC component on Join PCB is damaged</p> <p>[Additional Explanation] When detect voltage of 1.2V is abnormal, it will report this error</p> <p>[Solution]</p>

ErrorSuggestion0065F061	<p>1. Export the log file</p> <p>2. Contact a qualified service engineer</p> <p>[Cause] The speed command is too large</p> <p>[Solution]</p>
ErrorSuggestion0065F062	<p>1. Shut down and reboot the robot</p> <p>2. Reduce the motion speed, check the flow and the speed and posture in each node</p> <p>3. If it still happens, export the Logs, Project and TCP used, and contact to your service engineer</p> <p>[Cause] The deviation between target and current position is too large</p> <p>[Solution]</p>
ErrorSuggestion0065F063	<p>1. Shut down and reboot the robot</p> <p>2. Reduce the motion speed, check the flow, speed and posture in each node</p> <p>3. If it still happens, export the Logs, Project and TCP used, and contact to your service engineer</p> <p>[Cause] The motor output command rises sudden and triggers motor hold protection</p> <p>[Caution]</p> <p>1. Check if there robot has collided to the surroundings seriously</p> <p>2. Check the description of this error code to see which joint it belongs to</p> <p>[Additional Explanation] When the robot collides to a solid object in a high speed, some of the joints may suffer a great torque on them and this causes the motor current raise rapidly and trigger this error</p> <p>[Precaution] Do not drive the joint manually when this error occurs, which might damage the joint</p> <p>[Solution]</p>
ErrorSuggestion0065F064	<p>1. Shut down and reboot the robot</p> <p>2. Adjust the payload, safety settings, speed and see if the issue still happens</p> <p>3. Make sure the payload (including the tool) is within the spec.</p> <p>4. Adjust the speed or movement to prevent the risk of having a single joint accelerate too fast</p> <p>5. If it still happens, export the Logs, Project and TCP used, and contact to your service engineer</p> <p>6. Make sure the robot will not collide with the surroundings during project run</p> <p>[Cause] The motor current rises sudden and triggers motor hold protection</p> <p>[Caution]</p> <p>1. Check if there robot has collided to the surroundings seriously</p> <p>2. Check the description of this error code to see which joint it belongs to</p> <p>[Additional Explanation] When the robot collides to a solid object in a high speed, some of the joints may suffer a great torque on them and this causes the motor current raise rapidly and trigger this error</p> <p>[Precaution] Do not drive the joint manually when this error occurs, which might damage the joint</p> <p>[Solution]</p>
ErrorSuggestion0065F071	<p>1. Shut down and reboot the robot</p> <p>2. Adjust the payload, safety settings, speed and see if the issue still happens</p> <p>3. Make sure the payload (including the tool) is within the spec.</p> <p>4. Adjust the speed or movement to prevent the risk of having a single joint accelerate too fast</p> <p>5. If it still happens, export the Logs, Project and TCP used, and contact to your service engineer</p> <p>6. Make sure the robot will not collide with the surroundings during project run</p> <p>[Cause] Hardware Failure</p> <p>[Caution]</p> <p>[Additional Explanation] This error is not likely happens, mostly because of hardware issue</p> <p>[Solution]</p>

ErrorSuggestion0065F072	<ol style="list-style-type: none"> <li>1. Export the Logs</li> <li>2. Contact a qualified service engineer for further analysis</li> </ol> <p>[Cause] Robot detect the temperature on PCB is higher than spec.</p> <p>[Caution] 1. Check if the environment temperature is higher than the spec. while robot moving. 2. Check the temperature on View-&gt;Status</p> <p>[Additional Explanation] The temperature would rise during robot operating and the work space temperature will affect as well.</p> <p>[Solution]</p> <ol style="list-style-type: none"> <li>1. Make sure the temperature of the working environment is within the specification.</li> <li>2. Make sure the payload or the project speed is within the specification</li> <li>3. Shut down the robot, and keep it cool for a while before start up again.</li> <li>4. If this issue still occurs, please contact a qualified service engineer for further analysis</li> </ol>
ErrorSuggestion0065F073	<p>[Cause] G sensor overload</p> <p>[Caution]</p> <ol style="list-style-type: none"> <li>1. Check if there robot has collided to the surroundings seriously</li> <li>2. Check the description of this error code to see which joint it belongs to</li> </ol> <p>[Solution]</p> <ol style="list-style-type: none"> <li>1. Adjust the payload, safety settings, speed and see if the issue still happens</li> <li>2. Make sure the payload (including the tool) is within the spec.</li> <li>3. Adjust the speed or movement to prevent the risk of having a single joint accelerate too fast</li> <li>4. If it still happens, export the Logs, Project and TCP used, and contact to your service engineer</li> <li>5. Make sure the robot will not collide with the surroundings during project run</li> </ol>
ErrorSuggestion0065F074	<p>[Cause] Hardware Failure</p> <p>[Caution]</p> <p>[Additional Explanation] This error is not likely happens, mostly because of hardware issue</p> <p>[Solution]</p> <ol style="list-style-type: none"> <li>1. Export the Logs</li> <li>2. Contact a qualified service engineer for further analysis</li> </ol>
ErrorSuggestion0065F075	<p>[Cause] Hardware Failure</p> <p>[Caution]</p> <p>[Restriction] Do not drive the joint with or without drive power when this issue happens</p> <p>[Solution]</p> <ol style="list-style-type: none"> <li>1. Export the Logs</li> <li>2. Contact a qualified service engineer for further analysis</li> <li>3. Make sure that the robot does not collide with the surroundings during operation</li> </ol>
ErrorSuggestion0065F0A4	Please contact the original purchase of the manufacturer or a third party designated maintenance unit.
ErrorSuggestion0065F0A5	Please contact the original purchase of the manufacturer or a third party designated maintenance unit.
ErrorSuggestion0065F0A6	Please contact the original purchase of the manufacturer or a third party designated maintenance unit.
ErrorSuggestion0065F111	Please contact the original purchase of the manufacturer or a third party designated maintenance unit.
ErrorSuggestion0065F112	Please contact the original purchase of the manufacturer or a third party designated maintenance unit.
ErrorSuggestion0065F113	Please contact the original purchase of the manufacturer or a third party designated maintenance unit.
ErrorSuggestion0065F114	Please contact the original purchase of the manufacturer or a third party designated maintenance unit.
ErrorSuggestion0065F115	<p>[Cause] Encoder is abnormal</p> <p>[Caution]</p> <p>[Additional Explanation] This error is not likely happens, mostly because of hardware issue</p> <p>[Solution]</p>

	<ol style="list-style-type: none"> <li>1. Export the log,</li> <li>2. Contact a qualified service engineer for further analysis</li> </ol>
ErrorSuggestion0065F116	<ol style="list-style-type: none"> <li>1. Please try to restart the robot.</li> <li>2. If the restart is invalid, please contact the original purchase or third-party designated maintenance units.</li> </ol>
ErrorSuggestion0065F117	<ol style="list-style-type: none"> <li>1. Please try to restart the robot.</li> <li>2. If the restart is invalid, please contact the original purchase or third-party designated maintenance units.</li> </ol>
ErrorSuggestion0065F118	<ol style="list-style-type: none"> <li>1. Please try to restart the robot.</li> <li>2. If the restart is invalid, please contact the original purchase or third-party designated maintenance units.</li> </ol>
ErrorSuggestion0065F119	<p>[Cause]</p> <ol style="list-style-type: none"> <li>1. Motor is damaged</li> <li>2. Joint PCB is damaged</li> </ol> <p>[Caution]</p> <p>[Additional Explanation] When the resistance of UVW current of motor is abnormal, it will report this error</p> <p>[Solution]</p> <ol style="list-style-type: none"> <li>1. Export the log file</li> <li>2. Contact a qualified service engineer</li> </ol>
ErrorSuggestion0065F11A	<p>[Cause]Hardware Failure</p> <p>[Caution]</p> <p>[Additional Explanation] The cables connection of UVW of motor is not correct. Quality issue or the robot may be disassembled abnormally.</p> <p>[Solution]</p> <ol style="list-style-type: none"> <li>1. Export the log file</li> <li>2. Contact a qualified service engineer</li> <li>3. Make sure the robot is not being disassembled illegally</li> </ol>
ErrorSuggestion0065F11B	<p>[Cause] Hardware Failure</p> <p>[Caution]</p> <p>[Restriction] Do not drive the joint with or without drive power when this issue happens</p> <p>[Solution]</p> <ol style="list-style-type: none"> <li>1. Export the Logs</li> <li>2. Contact a qualified service engineer for further analysis</li> <li>3. Make sure that the robot does not collide with the surroundings during operation</li> </ol>
ErrorSuggestion0065F121	Please contact the original purchase of the manufacturer or a third party designated maintenance unit.
ErrorSuggestion0065F122	Please contact the original purchase of the manufacturer or a third party designated maintenance unit.
ErrorSuggestion0065F123	Please contact the original purchase of the manufacturer or a third party designated maintenance unit.
ErrorSuggestion0065F124	Please contact the original purchase of the manufacturer or a third party designated maintenance unit.
ErrorSuggestion0065F125	Please contact the original purchase of the manufacturer or a third party designated maintenance unit.
ErrorSuggestion0065F126	Please contact the original purchase of the manufacturer or a third party designated maintenance unit.
ErrorSuggestion0065F127	Please contact the original purchase of the manufacturer or a third party designated maintenance unit.
ErrorSuggestion0065F128	Please contact the original purchase of the manufacturer or a third party designated maintenance unit.
ErrorSuggestion0065F129	<p>[Cause]Encoder is abnormal</p> <p>[Caution]</p> <p>[Additional Explanation] This error is not likely happens, mostly because of hardware issue</p> <p>[Solution]</p> <ol style="list-style-type: none"> <li>1. Export the log,</li> <li>2. Contact a qualified service engineer for further analysis</li> </ol>
ErrorSuggestion0065F12A	Please contact the original purchase of the manufacturer or a third party designated maintenance unit.
ErrorSuggestion0065F12B	Please contact the original purchase of the manufacturer or a third party designated maintenance unit.



ErrorSuggestion0065F131	<p>1. Please check grounding line is normal or not.</p> <p>2. Please contact the original purchase of the manufacturer or a third party designated maintenance unit.</p>
ErrorSuggestion0065F132	Please contact the original purchase of the manufacturer or a third party designated maintenance unit.
ErrorSuggestion0065F133	<p>[Cause] Robot detect a sudden voltage drop on DCBUS.</p> <p>[Caution]</p> <p>[Additional Explanation] There may be a variety of reasons that cause a low voltage, for example:</p> <ol style="list-style-type: none"> <li>1. The payload and speed may not in the spec.</li> <li>2. Power supply is abnormal</li> </ol> <p>[Precaution] Power off and unplug the power cable before opening the control box for items checking</p> <p>[Solution]</p> <ol style="list-style-type: none"> <li>1. Shut down the robot, make sure the power source is stable then power on.</li> <li>2. Make sure the power source is robust for robot running.</li> <li>3. Adjust the payload, safety settings, speed and see if the issue still happens</li> <li>4. Make sure the payload (including the tool) is within the spec.</li> <li>5. Adjust the speed or movement to prevent the risk of having a single joint accelerate too fast</li> <li>6. If it still happens, export the Logs, Project and TCP used, and contact to your service engineer</li> </ol>
ErrorSuggestion0065F134	<p>[Cause] The communication time of EtherCAT is timeout</p> <p>[Caution] Check if any external EtherCAT device used has lost connection</p> <p>[Additional Explanation] System will periodic check the EtherCAT communication, if communication timeout, it will report this error.</p> <p>[Solution]</p> <p>Contact a qualified service engineer for further analysis</p>
ErrorSuggestion0065F135	<p>[Cause] Joint movement range is over range during brake release process</p> <p>[Caution] Check if the payload is too that out of specification, including the mass, center of mass, inertia, etc.</p> <p>[Additional Explanation] System will detect the movement range while brake release process, when the value is over expected, it will report this error.</p> <p>[Solution]</p> <ol style="list-style-type: none"> <li>1. Power off the robot</li> <li>2. Remove all payload and restart the robot</li> <li>3. Make sure the payload is within specification (including the center of mass and inertia)</li> <li>4. Make sure there is no unexpected force acting on the robot during brake release process</li> <li>5. If this issue still happens, have a qualified service engineer for further analysis</li> </ol>
ErrorSuggestion0065F136	<p>[Cause] Current for solenoid is over specification during brake release process</p> <p>[Additional Explanation] System will detect the current for solenoid during brake releasing process, when it find the value over specification, it will report this error</p> <p>[Solution]</p> <ol style="list-style-type: none"> <li>1. Please press ESTOP button and release it to resume Robot to see the issue is still occurred or not.</li> <li>2. If this still occurs, contact a qualified service engineer for further analysis</li> </ol>
ErrorSuggestion0065F137	<p>[Cause] Robot detect a low voltage on DCBUS.</p> <p>[Caution]</p> <p>[Additional Explanation] There may be a variety of reasons that cause a low voltage, for example:</p> <ol style="list-style-type: none"> <li>1. The power source is not stable on customer-site</li> <li>2. Power supply is abnormal</li> <li>3. etc.</li> </ol> <p>[Precaution] Power off and unplug the power cable before opening the control box for items checking</p> <p>[Solution]</p> <ol style="list-style-type: none"> <li>1. Shut down the robot, make sure the power source is stable then power on.</li> </ol>

ErrorSuggestion0065F138	<p>2. Make sure the power source is robust for robot running.</p> <p>3. If the same issue still occurs, contact a qualified service engineer for further analysis</p> <p>[Cause] Robot detect the voltage on DCBUS is higher than spec.</p> <p>[Caution] Check whether there are others error log along with this error.</p> <p>[Additional Explanation] There may be a variety of reasons that cause a high voltage, for example:</p> <ol style="list-style-type: none"> <li>1. The robot move too fast with the current project (with heavy payload)</li> <li>2. Power eater modules is abnormal</li> <li>3. etc.</li> </ol> <p>[Precaution] Power off and unplug the power cable before opening the control box for items checking</p> <p>[Solution]</p> <ol style="list-style-type: none"> <li>1. Make sure the robot would not be collided and be placed on a unstable platform.</li> <li>2. Make sure project speed with payload is within the specification.</li> <li>3. After restart the robot, the problem still occur, contact a qualified service engineer for further analysis</li> </ol>
ErrorSuggestion0065F139	<p>[Cause] Robot detect a sudden voltage drop on DCBUS.</p> <p>[Caution]</p> <p>[Additional Explanation] There may be a variety of reasons that cause a low voltage, for example:</p> <ol style="list-style-type: none"> <li>1. The payload and speed may not in the spec.</li> <li>2. Power supply is abnormal</li> </ol> <p>[Precaution] Power off and unplug the power cable before opening the control box for items checking</p> <p>[Solution]</p> <ol style="list-style-type: none"> <li>1. Shut down the robot, make sure the power source is stable then power on.</li> <li>2. Make sure the power source is robust for robot running.</li> <li>3. Adjust the payload, safety settings, speed and see if the issue still happens</li> <li>4. Make sure the payload (including the tool) is within the spec.</li> <li>5. Adjust the speed or movement to prevent the risk of having a single joint accelerate too fast</li> <li>6. If it still happens, export the Logs, Project and TCP used, and contact to your service engineer</li> </ol>
ErrorSuggestion0065F141	<ol style="list-style-type: none"> <li>1. Please try to restart the robot.</li> <li>2. If the restart is invalid, please contact the original purchase or third-party designated maintenance units.</li> </ol>
ErrorSuggestion0065F142	<ol style="list-style-type: none"> <li>1. Please try to restart the robot.</li> <li>2. If the restart is invalid, please contact the original purchase or third-party designated maintenance units.</li> </ol>
ErrorSuggestion0065F143	<ol style="list-style-type: none"> <li>1. Please try to restart the robot.</li> <li>2. If the restart is invalid, please contact the original purchase or third-party designated maintenance units.</li> </ol>
ErrorSuggestion0065F144	<ol style="list-style-type: none"> <li>1. Please try to restart the robot.</li> <li>2. If the restart is invalid, please contact the original purchase or third-party designated maintenance units.</li> </ol>
ErrorSuggestion0065F145	<p>[Cause] Encoder is dysfunctional</p> <p>[Caution]</p> <p>[Additional Explanation] This error is not likely happens, mostly because of hardware issue</p> <p>[Solution]</p> <ol style="list-style-type: none"> <li>1. Export the Logs</li> <li>2. Contact a qualified service engineer for further analysis</li> </ol>
ErrorSuggestion0065F146	<p>[Cause] Encoder is dysfunctional</p> <p>[Caution]</p> <p>[Additional Explanation] This error is not likely happens, mostly because of hardware issue</p> <p>[Solution]</p> <ol style="list-style-type: none"> <li>1. Export the Logs</li> <li>2. Contact a qualified service engineer for further analysis</li> </ol>

ErrorSuggestion0065F147	<p>[Cause] Encoder is dysfunctional</p> <p>[Caution]</p> <p>[Additional Explanation] This error is not likely happens, mostly because of hardware issue</p> <p>[Solution]</p> <ol style="list-style-type: none"> <li>1. Export the Logs</li> <li>2. Contact a qualified service engineer for further analysis</li> </ol>
ErrorSuggestion0065F148	<p>[Cause] Encoder is dysfunctional</p> <p>[Caution]</p> <p>[Additional Explanation] This error is not likely happens, mostly because of hardware issue</p> <p>[Solution]</p> <ol style="list-style-type: none"> <li>1. Export the Logs</li> <li>2. Contact a qualified service engineer for further analysis</li> </ol>
ErrorSuggestion0065F149	<ol style="list-style-type: none"> <li>1. Please try to restart the robot.</li> <li>2. If the restart is invalid, please contact the original purchase or third-party designated maintenance units.</li> </ol>
ErrorSuggestion0065F1A1	<ol style="list-style-type: none"> <li>1. Please try to restart the robot.</li> <li>2. If the restart is invalid, please contact the original purchase or third-party designated maintenance units.</li> </ol>
ErrorSuggestion0065F1A2	<ol style="list-style-type: none"> <li>1. Please try to restart the robot.</li> <li>2. If the restart is invalid, please contact the original purchase or third-party designated maintenance units.</li> </ol>
ErrorSuggestion0065F1A3	<ol style="list-style-type: none"> <li>1. Please try to restart the robot.</li> <li>2. If the restart is invalid, please contact the original purchase or third-party designated maintenance units.</li> </ol>
ErrorSuggestion0065FF20	<p>[Cause] Current for solenoid is over specification during brake release process</p> <p>[Additional Explanation] System will detect the current for solenoid during brake releasing process, when it find the value over specification, it will report this error</p> <p>[Solution]</p> <ol style="list-style-type: none"> <li>1. Please press ESTOP button and release it to resume Robot to see the issue is still occurred or not.</li> <li>2. If this still occurs, contact a qualified service engineer for further analysis</li> </ol>
ErrorSuggestion0065FF21	<p>[Cause]Joint movement range is over range during brake release process</p> <p>[Caution]Check if the payload is too that out of specification, including the mass, center of mass, inertia, etc.</p> <p>[Additional Explanation] System will detect the movement range while brake release process, when the value is over expected, it will report this error.</p> <p>[Solution]</p> <ol style="list-style-type: none"> <li>1. Power off the robot</li> <li>2. Remove all payload and restart the robot</li> <li>3. Make sure the payload is within specification (including the center of mass and inertia)</li> <li>4. Make sure there is no unexpected force acting on the robot during brake release process</li> <li>5. If this issue still happens, have a qualified service engineer for further analysis</li> </ol>
ErrorSuggestion0065FFA0	<p>[Cause]Robot detect a low voltage on DCBUS.</p> <p>[Caution]Check if the payload is too that out of specification, including the mass, center of mass, inertia, etc.</p> <p>[Additional Explanation] There may be a variety of reasons that cause a low voltage, for example:</p> <ol style="list-style-type: none"> <li>1. The power source is not stable on customer-site</li> <li>2. Power supply is abnormal</li> <li>3. etc.</li> </ol> <p>[Precaution] Power off and unplug the power cable before opening the control box for items checking</p> <p>[Solution]</p> <p>Shut down the robot, make sure the power source is stable then power on. If the same issue still occurs, contact a qualified service engineer for further analysis</p> <p>Make sure the power source is robust for robot running.</p>

ErrorSuggestion0065FFA1	<p>[Cause]Robot detect the voltage on DCBUS is higher than spec.</p> <p>[Caution]Check whether there are others error log along with this error.</p> <p>[Additional Explanation] There may be a variety of reasons that cause a high voltage, for example:</p> <ol style="list-style-type: none"> <li>1. The robot move too fast with the current project (with heavy payload)</li> <li>2. Power eater modules is abnormal</li> <li>3. etc.</li> </ol> <p>[Precaution] Power off and unplug the power cable before opening the control box for items checking</p> <p>[Solution]</p> <p>After restart the robot, the problem still occur, contact a qualified service engineer for further analysis</p> <ol style="list-style-type: none"> <li>1. Make sure the robot would not be collided and be placed on a unstable platform.</li> <li>2. Make sure project speed with payload is within the specification.</li> </ol>
ErrorSuggestion0065FFA2	Be careful! G sensor overload on X direction.
ErrorSuggestion0065FFA3	Be careful! G sensor overload on Y direction.
ErrorSuggestion0065FFA4	Be careful! G sensor overload on Z direction.
ErrorSuggestion0065FFA5	<p>[Cause]Robot detect the temperature on PCB is higher than spec.</p> <p>[Caution]1. Check if the environment temperature is higher than the spec. while robot moving.</p> <p>2. Check the temperature on View-&gt;Status</p> <p>[Additional Explanation] The temperature would rise during robot operating and the work space temperature will affect as well.</p> <p>[Solution]</p> <p>Shut down the robot, and keep it cool for a while before start up again. If this issue still occurs, please contact a qualified service engineer for further analysis</p> <ol style="list-style-type: none"> <li>1. Make sure the temperature of the working environment is within the specification.</li> <li>2. Make sure the payload or the project speed is within the specification</li> </ol>
ErrorSuggestion0065FFA6	<p>[Cause]Robot has detected an overshoot of U phase current on the motor</p> <p>[Caution]</p> <ol style="list-style-type: none"> <li>1. Check the header of the error code to see which motor is with this issue</li> <li>2. Check if the robot is run with payload out of spec. and also in high speed</li> <li>3. Check if the safety settings of the robot</li> </ol> <p>[Additional Explanation] If the robot is driven and accelerate fast, current of the motor will overshoot and trigger this error</p> <p>[Additional Explanation] This is usually be triggered when running the robot with a heavy payload with high speed which is nearly or already out of spec.</p> <p>[Additional Explanation] Another reason may be there is dysfunction on the electronics on the motors</p> <p>[Solution]</p> <ol style="list-style-type: none"> <li>1. Shut down and reboot the robot</li> <li>2. Adjust the payload, safety settings, speed and see if the issue still happens</li> <li>3. Make sure the payload (including the tool) is within the spec.</li> <li>4. Adjust the speed or movement to prevent the risk of having a single joint accelerate too fast</li> <li>5. If it still happens, export the Logs, Project and TCP used, and contact to your service engineer</li> </ol>
ErrorSuggestion0065FFA7	<p>[Cause]Robot has detected a overshoot of V phase current on the motor</p> <p>[Caution]</p> <ol style="list-style-type: none"> <li>1. Check the header of the error code to see which motor is with this issue</li> <li>2. Check if the robot is run with payload out of spec. and also in high speed</li> <li>3. Check if the safety settings of the robot</li> </ol> <p>[Additional Explanation] If the robot is driven and accelerate fast, current of the motor will overshoot and trigger this error</p>

ErrorSuggestion0065FFA8	<p>[Additional Explanation] This is usually be triggered when running the robot with a heavy payload with high speed which is nearly or already out of spec.</p> <p>[Additional Explanation] Another reason may be there is dysfunction on the electronics on the motors</p> <p>[Solution]</p> <ol style="list-style-type: none"> <li>1. Shut down and reboot the robot</li> <li>2. Adjust the payload, safety settings, speed and see if the issue still happens</li> <li>3. Make sure the payload (including the tool) is within the spec.</li> <li>4. Adjust the speed or movement to prevent the risk of having a single joint accelerate too fast</li> <li>5. If it still happens, export the Logs, Project and TCP used, and contact to your service engineer</li> </ol> <p>[Cause]Robot has detected a overshoot of W phase current on the motor</p> <p>[Caution]</p> <ol style="list-style-type: none"> <li>1. Check the header of the error code to see which motor is with this issue</li> <li>2. Check if the robot is run with payload out of spec. and also in high speed</li> <li>3. Check if the safety settings of the robot</li> </ol> <p>[Additional Explanation] If the robot is driven and accelerate fast, current of the motor will overshoot and trigger this error</p>
ErrorSuggestion0065FFA9	<p>[Additional Explanation] This is usually be triggered when running the robot with a heavy payload with high speed which is nearly or already out of spec.</p>
ErrorSuggestion0065FFAA	<p>[Additional Explanation] Another reason may be there is dysfunction on the electronics on the motors</p>
ErrorSuggestion0065FFAB	<p>[Solution]</p> <ol style="list-style-type: none"> <li>1. Shut down and reboot the robot</li> <li>2. Adjust the payload, safety settings, speed and see if the issue still happens</li> <li>3. Make sure the payload (including the tool) is within the spec.</li> <li>4. Adjust the speed or movement to prevent the risk of having a single joint accelerate too fast</li> <li>5. If it still happens, export the Logs, Project and TCP used, and contact to your service engineer</li> </ol> <p>Be careful! Motor current protection on U phase triggered, which may be caused by impact.</p> <p>Be careful! Motor current protection on V phase triggered, which may be caused by impact.</p> <p>[Cause]The motor current rises sudden and triggers motor hold protection</p> <p>[Caution]</p> <ol style="list-style-type: none"> <li>1. Check if there robot has collided to the surroundings seriously</li> <li>2. Check the description of this error code to see which joint it belongs to</li> </ol> <p>[Additional Explanation] When the robot collides to a solid object in a high speed, some of the joints may suffer a great torque on them and this causes the motor current raise rapidly and trigger this error</p>
ErrorSuggestion0065FFAC	<p>[Precaution] Do not drive the joint manually when this error occurs, which might damage the joint</p>
ErrorSuggestion0065FFAD	<p>[Solution]</p> <ol style="list-style-type: none"> <li>1. Shut down and reboot the robot</li> <li>2. Adjust the payload, safety settings, speed and see if the issue still happens</li> <li>3. Make sure the payload (including the tool) is within the spec.</li> <li>4. Adjust the speed or movement to prevent the risk of having a single joint accelerate too fast</li> <li>5. If it still happens, export the Logs, Project and TCP used, and contact to your service engineer</li> <li>6. Make sure the robot will not collide with the surroundings during project run</li> </ol>
ErrorSuggestion0065FFAE	<p>a error occurred in the UVW signal on optical encoder</p> <p>The index of encoder is not calibrated.</p> <p>[Cause]Robot has detected the current on DCBUS went too high suddenly.</p> <p>[Caution]</p> <ol style="list-style-type: none"> <li>1. The speed(ABS/project speed) is too fast.</li> </ol>

	<p>2. Check whether there is any collision while robot moving.</p> <p>[Additional Explanations] If robot is moving in a high speed in some movement or pose, it would cause this error. And if robot has collisions, it would cause the current became abnormal.</p> <p>[Solution][General User]</p> <ol style="list-style-type: none"> <li>1. Slow down the speed(ABS/project speed).</li> <li>2. Avoid any collision while robot is moving.</li> <li>3. After restart the robot, the problem still occur, contact a qualified service engineer for further analysis.</li> </ol>
ErrorSuggestion0065FFAF	<p>[Cause] The communication time of EtherCAT is timeout</p> <p>[Caution] Check if any external EtherCAT device used has lost connection</p> <p>[Additional Explanation] System will periodic check the EtherCAT communication, if communication timeout, it will report this error.</p> <p>[Solution]</p> <p>Contact a qualified service engineer for further analysis</p>
ErrorSuggestion0065FFB1	<p>[Cause] The communication time of SPI is timeout</p> <p>[Caution]</p> <p>[Additional Explanation] It may possibly because the SPI IC is dysfunction which is not likely to happen</p> <p>[Solution]</p> <p>Contact a qualified service engineer for further analysis</p>
ErrorSuggestion0065FFB2	<ol style="list-style-type: none"> <li>1. Please check grounding line is normal or not.</li> <li>2. Please contact the original purchase of the manufacturer or a third party designated maintenance unit.</li> </ol>
ErrorSuggestion0065FFB3	Please contact the original purchase of the manufacturer or a third party designated maintenance unit.
ErrorSuggestion0065FFB4	<ol style="list-style-type: none"> <li>1. Please try to restart the robot.</li> <li>2. If the restart is invalid, please contact the original purchase or third-party designated maintenance units.</li> </ol>
ErrorSuggestion0065FFB5	<ol style="list-style-type: none"> <li>1. Please try to restart the robot.</li> <li>2. If the restart is invalid, please contact the original purchase or third-party designated maintenance units.</li> </ol>
ErrorSuggestion0065FFB6	Please contact the original purchase of the manufacturer or a third party designated maintenance unit.
ErrorSuggestion0065FFB7	Please check the functionality of break unit
ErrorSuggestion0065FFB8	<p>[Cause] Hardware Failure</p> <p>[Caution]</p> <p>[Additional Explanation] This error is not likely happens, mostly because of hardware issue</p> <p>[Solution]</p> <ol style="list-style-type: none"> <li>1. Export the Logs</li> <li>2. Contact a qualified service engineer for further analysis</li> </ol>
ErrorSuggestion0065FFB9	<p>[Cause] Hardware Failure</p> <p>[Caution]</p> <p>[Additional Explanation] This error is not likely happens, mostly because of hardware issue</p> <p>[Solution]</p> <ol style="list-style-type: none"> <li>1. Export the Logs</li> <li>2. Contact a qualified service engineer for further analysis</li> </ol>
ErrorSuggestion0065FFBA	<p>[Cause] Hardware Failure</p> <p>[Caution]</p> <p>[Restriction] Do not pull the joint forcibly when the problem occurs, so as not to cause damage to the joint</p> <p>[Solution]</p> <ol style="list-style-type: none"> <li>1. Export the Logs</li> <li>2. Contact a qualified service engineer for further analysis</li> <li>3. Make sure that the robot does not collide with the surroundings during operation</li> </ol>
ErrorSuggestion0065FFC0	a error occurred in transit to absolute position

ErrorSuggestion0065FFC1	Please contact the original purchase of the manufacturer or a third party designated maintenance unit.
ErrorSuggestion0065FFC2	Please contact the original purchase of the manufacturer or a third party designated maintenance unit.
ErrorSuggestion0065FFC3	Please contact the original purchase of the manufacturer or a third party designated maintenance unit.
ErrorSuggestion0065FFC4	Please contact the original purchase of the manufacturer or a third party designated maintenance unit.
ErrorSuggestion0065FFC5	Please contact the original purchase of the manufacturer or a third party designated maintenance unit.
ErrorSuggestion0065FFC6	Please contact the original purchase of the manufacturer or a third party designated maintenance unit.
ErrorSuggestion0065FFC7	Please contact the original purchase of the manufacturer or a third party designated maintenance unit.
ErrorSuggestion0065FFC8	Please contact the original purchase of the manufacturer or a third party designated maintenance unit.
ErrorSuggestion0065FFC9	Please contact the original purchase of the manufacturer or a third party designated maintenance unit.
ErrorSuggestion0065FFCA	[Cause] Encoder is dysfunctional [Caution] [Additional Explanation] This error is not likely happens, mostly because of hardware issue [Solution] 1. Export the Logs 2. Contact a qualified service engineer for further analysis
ErrorSuggestion0065FFCB	Please reduce the motion speed, check the flow and the speed and posture in each node
ErrorSuggestion0065FFCC	[Cause] Encoder is dysfunctional [Caution] [Additional Explanation] This error is not likely happens, mostly because of hardware issue [Solution] 1. Export the Logs 2. Contact a qualified service engineer for further analysis
ErrorSuggestion0065FFCD	[Cause] Hardware Failure [Caution] [Restriction] Do not drive the joint with or without drive power when this issue happens [Solution] 1. Export the Logs 2. Contact a qualified service engineer for further analysis 3. Make sure that the robot does not collide with the surroundings during operation
ErrorSuggestion0065FFCE	[Cause] Hardware Failure [Caution] [Restriction] Do not drive the joint with or without drive power [Solution] 1. Export the Logs 2. Contact a qualified service engineer for further analysis
ErrorSuggestion0065FFCF	[Cause] The motor current rises sudden and triggers motor hold protection [Caution] 1. Check if there robot has collided to the surroundings seriously 2. Check the description of this error code to see which joint it belongs to [Additional Explanation] When the robot collides to a solid object in a high speed, some of the joints may suffer a great torque on them and this causes the motor current raise rapidly and trigger this error  [Precaution] Do not drive the joint manually when this error occurs, which might damage the joint [Solution] 1. Shut down and reboot the robot 2. Adjust the payload, safety settings, speed and see if the issue still happens 3. Make sure the payload (including the tool) is within the spec.



	<p>4. Adjust the speed or movement to prevent the risk of having a single joint accelerate too fast</p> <p>5. If it still happens, export the Logs, Project and TCP used, and contact to your service engineer</p> <p>6. Make sure the robot will not collide with the surroundings during project run</p>
ErrorSuggestion0065FFD0	Please check the UVW signal on encoder
ErrorSuggestion0065FFD1	<p>[Cause] Hardware Failure</p> <p>[Caution] Check if the robot is placed near any device with strong magnetic field</p> <p>[Additional Explanation] Under a strong magnetic field may affect the readings of the magnetic encoder</p> <p>[Solution]</p> <ol style="list-style-type: none"> <li>1. Export the Logs</li> <li>2. Make sure the robot is not under any strong magnetic field and then reboot the robot</li> <li>3. If this still does not work, Contact a qualified service engineer for further analysis</li> </ol>
ErrorSuggestion0065FFD2	<p>[Cause] Hardware Failure</p> <p>[Caution] Check if the robot is placed near any device with strong magnetic field</p> <p>[Additional Explanation] Under a strong magnetic field may affect the readings of the magnetic encoder</p> <p>[Solution]</p> <ol style="list-style-type: none"> <li>1. Export the Logs</li> <li>2. Make sure the robot is not under any strong magnetic field and then reboot the robot</li> <li>3. If this still does not work, Contact a qualified service engineer for further analysis</li> </ol>
ErrorSuggestion0065FFD3	<p>[Cause]</p> <ol style="list-style-type: none"> <li>1. The robot may be disassembled abnormally. Please check the warranty sticker and thread-locking fluid are both broken or not</li> <li>2. Joint gear wear out</li> </ol> <p>[Caution]</p> <p>[Additional Explanation] When the origin of joint module is not detected, it will report this error</p> <p>[Solution]</p> <ol style="list-style-type: none"> <li>1. Export the Logs</li> <li>2. Contact a qualified service engineer for further analysis</li> </ol>
ErrorSuggestion0065FFD4	Please contact the original purchase of the manufacturer or a third party designated maintenance unit.
ErrorSuggestion0065FFD5	Please contact the original purchase of the manufacturer or a third party designated maintenance unit.
ErrorSuggestion0065FFD6	Please contact the original purchase of the manufacturer or a third party designated maintenance unit.
ErrorSuggestion0065FFD7	Please contact the original purchase of the manufacturer or a third party designated maintenance unit.
ErrorSuggestion0065FFD8	<p>[Cause]</p> <ol style="list-style-type: none"> <li>1. Motor is damaged</li> <li>2. Joint PCB is damaged</li> </ol> <p>[Additional Explanation] When the resistance of UVW current of motor is abnormal, it will report this error</p> <p>[Solution]</p> <ol style="list-style-type: none"> <li>1. Export the log file</li> <li>2. Contact a qualified service engineer</li> </ol>
ErrorSuggestion0065FFD9	<p>[Cause] Hardware Failure</p> <p>[Additional Explanation] The cables connection of UVW of motor is not correct. Quality issue or the robot may be disassembled abnormally.</p> <p>[Solution]</p> <ol style="list-style-type: none"> <li>1. Export the log file</li> <li>2. Contact a qualified service engineer</li> <li>3. Make sure the robot is not being disassembled illegally</li> </ol>
ErrorSuggestion0065FFDA	Please contact the original purchase of the manufacturer or a third party designated maintenance unit.
ErrorSuggestion0065FFDB	Please contact the original purchase of the manufacturer or a third party designated maintenance unit.



ErrorSuggestion0065FFDC	Please contact the original purchase of the manufacturer or a third party designated maintenance unit.
ErrorSuggestion0065FFDD	1. Please restart the robot. 2. If the restart is invalid, please contact the original purchase or third-party designated maintenance units.
ErrorSuggestion0065FFDE	1. Please restart the robot. 2. If the restart is invalid, please contact the original purchase or third-party designated maintenance units.
ErrorSuggestion0065FFDF	1. Please restart the robot. 2. If the restart is invalid, please contact the original purchase or third-party designated maintenance units.
ErrorSuggestion0065FFE0	[Cause] 1. Power supply is not stable. 2. Robot moves in high speed, current is higher, voltage loss getting higher.(Vinput-Vloss=V for DC bus) 3. Power connector problem, consume too much power [Additional Explanation] When robot is working and detects the voltage of DC bus is low, it will report this error [Solution] 1. Power off the robot 2. Check Robot Cable and its connector before power on again 3. Reduce Robot speed if necessary Make sure power source is stable
ErrorSuggestion0065FFE1	Please contact the original purchase of the manufacturer or a third party designated maintenance unit.
ErrorSuggestion0065FFE2	1. Please restart the robot. 2. If the restart is invalid, please contact the original purchase or third-party designated maintenance units.
ErrorSuggestion0065FFE3	1. Please restart the robot. 2. If the restart is invalid, please contact the original purchase or third-party designated maintenance units.
ErrorSuggestion0065FFE4	[Cause] Encoder is abnormal [Additional Explanation] This error is not likely happens, mostly because of hardware issue [Solution] 1. Export the log file 2. Contact a qualified service engineer
ErrorSuggestion0065FFE5	1. Please restart the robot. 2. If the restart is invalid, please contact the original purchase or third-party designated maintenance units.
ErrorSuggestion0065FFE6	1. Please restart the robot. 2. If the restart is invalid, please contact the original purchase or third-party designated maintenance units.
ErrorSuggestion0065FFE7	Please contact the original purchase of the manufacturer or a third party designated maintenance unit.
ErrorSuggestion0065FFE8	[Cause]Hardware Failure [Additional Explanation] When the output of the G sensor is abnormal, it will report this error [Solution] 1. Export the log file 2. Contact a qualified service engineer
ErrorSuggestion0065FFE9	Please contact the original purchase of the manufacturer or a third party designated maintenance unit.
ErrorSuggestion0065FFEA	[Cause] DC to DC component on Join PCB is damaged [Additional Explanation] When detect voltage of 5V is abnormal, it will report this error [Solution] 1. Export the log file 2. Contact a qualified service engineer
ErrorSuggestion0065FFEB	[Cause] DC to DC component on Join PCB is damaged [Additional Explanation] When detect voltage of 12V is abnormal, it will report this error [Solution]

	1. Export the log file
	2. Contact a qualified service engineer
ErrorSuggestion0065FFEC	Please contact the original purchase of the manufacturer or a third party designated maintenance unit.
ErrorSuggestion0065FFED	[Cause] Encoder abnormal
	[Additional Explanation] This error is not likely happens, mostly because of hardware issue
	[Solution]
	[Solution]
	1. Export the log file
	2. Contact a qualified service engineer
ErrorSuggestion0065FFEE	Please turn on joint modules
ErrorSuggestion0065FFEF	Please contact the original purchase of the manufacturer or a third party designated maintenance unit.
ErrorSuggestion0016AA11	1. Please try to restart the robot.
	2. If the restart is invalid, please contact the original purchase or third-party designated maintenance units.
ErrorSuggestion0016AA12	1. Please try to restart the robot.
	2. If the restart is invalid, please contact the original purchase or third-party designated maintenance units.
ErrorSuggestion0016AA13	1. Please try to restart the robot.
	2. If the restart is invalid, please contact the original purchase or third-party designated maintenance units.
ErrorSuggestion0016AA14	1. Please try to restart the robot.
	2. If the restart is invalid, please contact the original purchase or third-party designated maintenance units.
ErrorSuggestion0016AA15	1. Please try to restart the robot.
	2. If the restart is invalid, please contact the original purchase or third-party designated maintenance units.
ErrorSuggestion0016AA16	1. Please try to restart the robot.
	2. If the restart is invalid, please contact the original purchase or third-party designated maintenance units.
ErrorSuggestion0016AA17	1. Please try to restart the robot.
	2. If the restart is invalid, please contact the original purchase or third-party designated maintenance units.
ErrorSuggestion0016AA18	1. Please try to restart the robot.
	2. If the restart is invalid, please contact the original purchase or third-party designated maintenance units.
ErrorSuggestion0016AA19	1. Please try to restart the robot.
	2. If the restart is invalid, please contact the original purchase or third-party designated maintenance units.
ErrorSuggestion0016AA1A	1. Please try to restart the robot.
	2. If the restart is invalid, please contact the original purchase or third-party designated maintenance units.
ErrorSuggestion0016AA1B	1. Please try to restart the robot.
	2. If the restart is invalid, please contact the original purchase or third-party designated maintenance units.
ErrorSuggestion0016AA1C	1. Please try to restart the robot.
	2. If the restart is invalid, please contact the original purchase or third-party designated maintenance units.
ErrorSuggestion0016AA1D	1. Please try to restart the robot.
	2. If the restart is invalid, please contact the original purchase or third-party designated maintenance units.
ErrorSuggestion0016AA1E	1. Please try to restart the robot.
	2. If the restart is invalid, please contact the original purchase or third-party designated maintenance units.
ErrorSuggestion0016AA1F	1. Please try to restart the robot.
	2. If the restart is invalid, please contact the original purchase or third-party designated maintenance units.
ErrorSuggestion0016AA21	1. Please try to restart the robot.
	2. If the restart is invalid, please contact the original purchase or third-party designated maintenance units.
ErrorSuggestion0016AA22	1. Please try to restart the robot.
	2. If the restart is invalid, please contact the original purchase or third-party designated maintenance units.
ErrorSuggestion0016AA23	1. Please try to restart the robot.
	2. If the restart is invalid, please contact the original purchase or third-party designated maintenance units.



































































**OMRON Corporation Industrial Automation Company**

**Kyoto, JAPAN**

**Contact : [www.ia.omron.com](http://www.ia.omron.com)**

**Regional Headquarters**

**OMRON EUROPE B.V.**

Wegalaan 67-69, 2132 JD Hoofddorp  
The Netherlands  
Tel: (31) 2356-81-300 Fax: (31) 2356-81-388

**OMRON ELECTRONICS LLC**

2895 Greenspoint Parkway, Suite 200  
Hoffman Estates, IL 60169 U.S.A.  
Tel: (1) 847-843-7900 Fax: (1) 847-843-7787

**OMRON ASIA PACIFIC PTE. LTD.**

438B Alexandra Road, #08-01/02 Alexandra  
Technopark, Singapore 119968  
Tel: (65) 6835-3011 Fax: (65) 6835-2711

**OMRON (CHINA) CO., LTD.**

Room 2211, Bank of China Tower,  
200 Yin Cheng Zhong Road,  
PuDong New Area, Shanghai, 200120, China  
Tel: (86) 21-5037-2222 Fax: (86) 21-5037-2200

**Authorized Distributor:**

©OMRON Corporation 2023 All Rights Reserved.  
In the interest of product improvement,  
specifications are subject to change without notice.

**Cat. No. I689-E-01** 0623

29888-400A